

adVANture
... in touch with the moment

2024



 **Frankana Freiko**®
Everything for Caravan | Camping | Leisure

You can find products from these manufacturers in the VAN catalogue:



adVANture

Free, independent and environmentally conscious

Dear Sir or Madam,

It has to be compact, light and individual. The perfect accessory for your VAN! During the compilation of the assortment of the **adVANture** catalogue for this year, we always kept exactly these attributes in mind.

VANlife is inseparably connected to freedom and independence. To experience this, one usually does not need much. And there are useful and partly indispensable helpers.

Our selection of options is designed to help you prepare for your adventure in the best way possible and tailored to your needs.

We would like to take this opportunity to draw special attention to the articles labelled with our **sustainability icon**.



After all, despite the infinite freedom offered by VANlife, we also have to keep the environment in mind.

All products of our **adVANture** catalogue are available at your Frankana Freiko retail partner. Furthermore, they are your first point of contact for individual advice and professional expertise.

We are sure that on the following 127 pages you will find something for your personal adventure. Whether your adventure is a 3-month expedition through Africa or a short weekend break in your neighbouring country.

We wish you a great time full of adventures in this special year with a total of 366 days and, above all, your own personal VANlife!

Your  **Frankana Freiko®** team

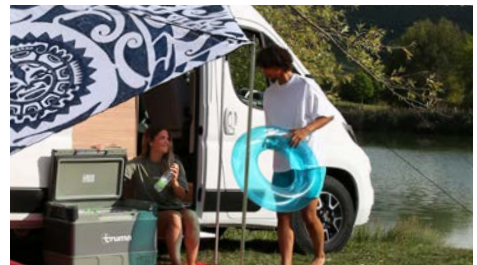

Frankana Freiko – your reliable partner:



You are interested in more products from the Frankana Freiko product range? The whole range of camping accessory articles can be found in the main catalogue and on www.camping-ist-bunt.de/en or <https://www.frankana.de/en>.



The Frankana Freiko newsletter comes out monthly and keeps you up-to-date on new products, events in the camping industry, tips and tricks and much more. Subscribe online!



You can also find us on social media! There, you can always find the latest VAN and camping trends.



 **Frankana Freiko®**

3



Tents

75



Gas

11



Awnings

83



Electronics

30



Bike Carriers

92



Household

44



Skylights
Insect
Protection

97



Furniture

48



Vehicle

100



Cooling

72



Water
Plumbing

107



Multimedia



Air conditioners	104 – 106	Magnet holders	9 – 10
Alarm systems	66 – 69	Mattresses	60
Awnings	4 – 6, 11 – 12, 14, 20, 22 – 24, 26	Mirrors	64
Awning accessories	19, 21, 24, 27, 29	Moniceivers	121, 125
Awning adapters	11 – 12, 15, 21, 25 – 26	Navigation systems	121 – 124, 126 – 127
Awning sets	13, 20	Neckband loudspeakers	119
Awning tents	17, 22, 27	Pavilion	6
Batteries	86, 89 – 90	Pots	96
Bed systems	59	Power inverter	86 – 87
Bike carriers	30 – 32, 34 – 38	Power supply	91
		Protective covers	56 – 57
Carpets	7, 58	Rain and wind deflectors	16 – 19
Chairs	97 – 99	Refrigerators	103 – 104
Chargers	88 – 90, 126 – 127	Reversing cameras	122 – 123, 125
Cleaning products	72 – 73, 92	Roof rails	33, 41 – 42
Coolers	101 – 102	Roof tents	3
		Rotary consoles	61
Darkening	50 – 52	Router sets	109, 112 – 116
Dog accessories	92	Safes	61, 69
Door locks	70	Satellite systems and acc.	107 – 111
Driver's cab beds	60	Seat covers	58
		Security	61, 66 – 70
Folding boxes	95	Showers	72
Furniture	97 – 99	Ski holders	32, 41
Gas bottles	75	Skylights	44 – 47
Gas content meter	79	Solar systems	83 – 85
Gas detectors	67 – 69	Steps	64 – 65
Gas supply	75 – 79	Sun canopies	7 – 8
Grills	81 – 82	Tables	98
		Tableware	96
Hobs	81	Thermal mats	54 – 55
Household accessories	92 – 96	Toilets and accessories	73 – 74
		Tow bars	39
Insect protection	48 – 49	Tracking systems	68
Kayak holder	40	TV sets	112 – 113, 117 – 120
Kid's beds	60	Ventilation grilles	53
Ladders	43	Wall holders	118 – 119
Levelling ramps	63	Warning plates	30
Load carriers	38 – 39	Weather protection	16 – 18, 28
Loudspeakers	117 – 120, 127 – 128	Wheel rims	62
Luggage boxes	32 – 33	Windows	44



Be close to the Sky!

Would you rather sleep under the stars than in a hotel? Would you like to be flexible when travelling and spontaneously escape the hustle and bustle of everyday life by car? For you, an overnight stay should be possible in almost any car park, at least in some countries? Then comfortably sleeping in a

roof tent on the roof of your car is just the thing for you. The roof tents in our range can be attached to almost any vehicle (car, pick-up, mini-van, van, trailer). Only two cross struts are required as load carriers. The roof tent is suitable for up to two people.

✓ Total freedom when camping by car



✓ telescopic aluminium ladder

2,699.00

i Polyester part made from rPET polyester from plastic bottles



Roof Tent Yano

The Yano roof tent with its low weight of approx. 38 kg leaves nothing to be desired in terms of features. The material is a 180 g/m² recycled Ripstop TC (cotton blend fabric made of 65 % polyester and 35 % cotton). The tent has excellent ventilation and many other well thought-out details, such as a storage pocket for shoes and a window for a view of the starry sky. The roof tent can be attached in a few steps with the help of a roof rack and can thus be mounted independently of the vehicle. A comfortable TPU air mattress, an extension ladder and a protective cover are included. This tent is completely PVC-free and one of the lightest roof tents on the market. Despite the simple construction, it offers

a lot of sleeping comfort. Thanks to the patter guard, which you can attach to the tent from the outside in case of rain, you will have a quieter night inside the tent.

Scope of delivery: car roof tent incl. frame, protective cover, shoe box, inflatable mattress with cotton cover (in the tent), telescopic aluminium ladder, patter guard/sun protection, fastening set, assembly instructions.

Colour: brown; Material: with PU coating, 100 % cotton blend fabric

Dimensions (LxWxH): 212x150x147 cm; Pack size: 220 x 165 x 42 cm; Weight: 38.5 kg

075/597 2,699.00

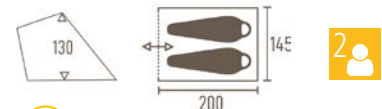

✓ good ventilation thanks to entrance and windows



299.00

+ Accessories

Canvas Awning for Yano

The Yano canvas awning is the perfect addition to the roof tent Yano. It offers plenty of space to relax in the shade at warm, sunny places and also protects your equipment when it rains.

The canvas awning is fixed to the frame with velcro straps, tensioned with straps and set up variably in height and according to your needs using the pitching poles supplied. This ensures a dry

NEW

and protected passage to the roof tent and a dry shelter for your meals.

Colour: brown; Material: 100 % recycled PET, Oxford Polyester; Dimensions (LxWxH):

370x490x0.3 cm; Pack size: 97 x 14.5 x 14.5 cm

075/580 299.00



Airtube
freestanding

719.00

+ Accessories



31.00

Roof Lining Quick'n Easy

The roof lining for your partial tent Quick'n Easy Air creates a comfortable living environment and reduces the formation of condensed water.

075/190 31.00

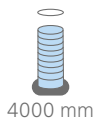

4000 mm

w/o ill. Electric Air Pump

You no longer have to pump by hand as the electric compressor with 12 V connection and pressure indicator inflates your tent in no time. Equipped with a digital manometer for pressure indication in PSI or bar.

075/464 139.00

Westfield
Top Quality Concept



Airtube
freestanding

599.00

+ Accessories

Connector Hydra

The functional connector is available in three connection heights and connects the partial tent Hydra to your vehicle. The connector is attached to the tent via a zip fastener and to your motorhome via a piping.

Mounting height: 180 – 210 cm	075/626	99.95
Mounting height: 210 – 240 cm	075/627	109.95
Mounting height: 240 – 270 cm	075/628	119.95



Van Awning Quick'n Easy Air

A small pack size and ease of use characterise this awning, as does the impeccable price-performance ratio. The freestanding van awning is suitable for nearly all vans thanks to a sewn-in connector. Due to its low weight and various ventilation possibilities, the partial tent is the perfect companion for your next holiday.

Front wall: can be rolled up, with window as well as closable gauze window insert for great air circulation.

Side walls: with one window and one window cover each.

Rear wall: with one door.

Connector: the sewn-on connection between partial tent and van. Double piping 4 mm/6 mm. Connection to the vehicle with detachable piping, as well as a zip across the van with two tensioning straps. With door, can be rolled up.

Material: Weathertex polyester fabric, PU-coated.

Poles: Airtube

Scope of delivery: tensioning material, Airtube, air pump, transport bag, tent

Dimensions(WxHxD): 265x210x350 cm; Pack size: 79 x 36 x 35 cm;

Weight: 13 kg

Mounting height: 180 – 210 cm

075/183 719.00

Mounting height: 240 – 270 cm

075/403 739.00



Main catalogue

Other van awnings can be found in the main catalogue starting from page 28.

Partial Tent Hydra

The inflatable awning Hydra for vans or motorhomes offers optimum use of space thanks to its modified front air tube shape. You can fully use the floor space and have headroom in the entire roof area. A removable connector (not included in delivery) makes it easy to set up and take down the tent. Another advantage is that a low weight has to be pulled into the awning. Thanks to the air tube system, the air chambers are inflated in a short time. The supplied groundsheet offers maximum flexibility and can be attached to the awning with Velcro. With the help of the optionally available Drive-Away-Kit (610/262), the partial tent becomes freestanding and can be left at the campsite.

Front wall and side walls with windows and ventilation flaps for perfect ventilation. Front door with panorama window and sun canopy function.

Material: high-quality HydraDore® SL Pro outer fabric with UV finish provides increased tear resistance and is particularly quick-drying.

Poles: air tubes (AES)

Scope of delivery: tensioning material, Airtube, air pump, groundsheet, transport bag, tent

Dimensions(WxHxD): 300x180x240 cm; Pack size: 103 x 31 x 30 cm;

Weight: 13 kg

075/625 599.00



3000 mm



1,149.00



Accessories

Connector Orion

The functional connector connects the freestanding van awning Orion to your vehicle. The connector is fastened to the awning via zip and to the motorhome via piping.



Large clear windows

Mounting height	Weight	Item no.	Price
180 – 210 cm	5 kg	075/785	199.95
210 – 240 cm	5 kg	075/786	219.95
240 – 270 cm	5 kg	075/787	229.95



119.90

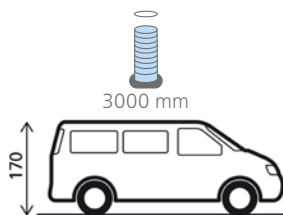

Easy installation at the rear door

**Rear Tent Pilote**

The specially designed frameless tailgate tent is attached to the tailgate of the VW Caddy. Ideal for creating additional space at the rear of the vehicle and gaining a little more freedom of movement inside. Quick and easy to attach. A large entrance door allows good ventilation and a pleasant interior climate. With fixing material and carry bag. Pitching poles are optionally available.

Material: 100 % polyester**VW Caddy IV, all models, 06/2015 – 02/2020**

Dimensions (WxHxD): 135x200x135 cm; Pack size: 45,5 x 18 x 17 cm;

Weight: 2.1 kg **075/381 119.90****VW Caddy V, all models, 2020 – ...**

Dimensions (WxHxD): 135x200x135 cm; Pack size: 50 x 12 x 12 cm;

Weight: 2.5 kg **072/391 139.90**

Steel



Freestanding rear tent for increased space!

179.90

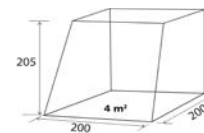
**Rear Tent Comet VW T5/T6**

Easy installation, frameless construction and a highly compact pack size make the Comet tailgate tent the perfect choice for all VW T5/T6 owners. It creates additional space at the rear where you can store bicycles, cook, or sleep.

Put the Comet across your VW's tailgate. No frame necessary. Two large entrance doors ensure great air circulation and a pleasant indoor climate.

Material: 150D Oxford polyester PU**Poles:** 2 pitching poles ø 16 mm steel, 195 cm.

Dimensions (WxHxD): 200x205x200 cm; Pack size: 66 x 20 x 19 cm;

Weight: 5.1 kg **075/195 179.90**

Van Awning Orion 2.0 **NEW**
Westfield
 Top Quality Concept

Mounting height: 180 – 270 cm

The freestanding inflatable awning with AAS system is quick and easy to set up and suitable for vans and motorhomes between 180 and 270 cm. The connector with two doors is available in three sizes and connects the freestanding inflatable awning to your vehicle. It is fastened to the awning via zip and to the vehicle via piping. Alternatively, you can use a connecting pole or tension the connector over the vehicle using guy ropes. The awning has large panorama windows, optimal headroom and a spacious interior. Optional extension: the extension Eris.

Front wall: with door. Can be folded down or removed if required.**Side walls:** with mosquito net. Can be folded down or removed if required.**Material:** HydroTech® CottonTouch 100 % polyester**Poles:** Advanced Air System® (AAS)**Scope of delivery:** tensioning material, Airtube, air pump, front pole (ø 19 mm aluminium), transport bag, tent

Dimensions (WxHxD): 300x220x250 cm; Pack size: 100 x 42 x 35 cm;

Weight: 26 kg **075/784 1,149.00**



- freestanding
- UV 50+
- Airtube

499.00

Rear Tent Cruiser Air

The freestanding, inflatable rear tent fits almost all estate cars, SUVs and minivans. Equipped with AirTube system (2 main tubes and storm tube) for quick and easy setup. The tent can be easily separated from the car without having to take it down. Offers enough space for 4 people and has a large, closable mesh window for optimal ventilation. There is a mesh door on each side. The sewn-on groundsheet ensures that dirt and water stay outside. Mounting height: 200 cm.

Material: 150D Oxford 100 % polyester

Poles: ø 10 cm air tubes, ø 9.5 mm GRP fibre-glass for canopy arch.

Scope of delivery: ø 9.5 mm GRP poles, tensioning material, Airtube, air pump, transport bag, tent

Dimensions (WxHxD): 230x205x280 cm; Pack size: 74 x 36 x 36 cm; Weight: 10.9 kg

075/539 499.00



NEW

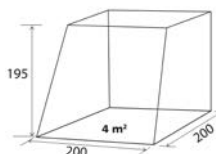

Rear Tent Escape

The frameless tailgate tent fits various identical vehicle models: Peugeot Traveller, Citroën Space-tourer and Toyota Proace. Quick and easy installation without tools using magnetic strips and straps. Very wind-resistant thanks to tensioning straps. The external mud flap keeps rainwater out. Incl. 30 cm plastic pegs and bag. The bike carrier can remain attached to the tailgate. Roll-

up front wall and side walls with windows and blackout blinds.

Material: 150D Oxford polyester

Scope of delivery: 2 pitching poles, tensioning material, transport bag, tent

Dimensions (WxHxD): 200x195x200 cm; Pack size: 63 x 18 x 18 cm; Weight: 4.5 kg

072/392 179.90



179.90



269.00

- Steel
- UV 50+

Pavilion Event Shelter Pro M

The Coleman® Event Shelter Pro is available in two different sizes and offers a place in the shade for you, your family and your friends – in your garden or on your terrace. The 19 mm steel poles are robust, the taped seams waterproof and the roof is able to withstand a hydrostatic head of 1000 mm.

The Event Shelter Pro is reliable and easy to set up thanks to its well thought-out design. Thanks to UV Guard™, you are well-protected against UV rays with a sun protection factor of 50+. The robust connection feet keep the poles together and can simultaneously be used to hammer down the pegs included in delivery.

Accessories

without illustration: Side Wall Event Shelter Pro M

Sun protection and privacy shield for Event Shelter Pro, with windows and door.

Dimensions (WxH): 300x218 cm; Pack size: 36 x 24 x 3 cm; Weight: 700 g 075/085 37.95

Shelter Connector M

Polyester connector for your van and the pavilion Event Shelter Pro.

Dimensions (WxHxD): 305x180x150 cm; Pack size: 36 x 22,8 x 17,3 cm; Weight: 2.05 kg

075/086 135.00

Scope of delivery: ø 19 mm steel poles, tensioning material, pavilion

Material: 100 % PES polyester, with PU coating, taped seams;

Dimensions (WxHxD): 300x218x300 cm; Pack size: 83 x 28.5 x 23 cm; Weight: 15.5 kg

075/084 269.00





Bent combines life-style, freedom and functionality.

Canvas Awning "TC Zip Canvas" Africa

The connectable Bent canvas awning "TC Zip Canvas Single" is modular, functional, versatile and particularly easy to use. Made of a robust polyester cotton mixed fabric (TC 65/35), with swelling cotton threads in the fabric. The TC Zip Canvas is characterised by its very high UV resistance and the TC fabric is PU-coated.

The connectable "TC Zip Canvas Single" canvas awning is equipped with high-quality SBS brand zips on the three sides.

Please order the pitching poles separately.

Scope of delivery: canvas awning, 3 guy ropes incl. bag, carry bag with drawstring.



Material: with PU coating, 65 % PES polyester, 35 % cotton, TC Technical Cotton;
Dimensions (WxD): 250x250 cm; Pack size: 50 x 14 x 8 cm; Weight: 950 g

Sand	072/637	109.95
Africa print	072/638	139.95
Zebra print	072/639	139.95
Nomad	072/642	109.95



1500 mm



Accessories

Canvas Awning "TC Zip-Protect Canvas"

The connectable awning made of a robust polyester-cotton blend fabric (TC 65/35) 210 g/m² has a high UV resistance. The TC fabric has a hydrostatic head of 450 mm. Thanks to the triangular design and the reinforced corners, you can tension the awning optimally. With convenient TC bag with quick-release fastener, shoulder straps and a small pack size for easy transport. Free from environmentally harmful perfluorocarbons (PFC).

Scope of delivery: canvas awning, 3 guy ropes with aluminium three-hole tensioner incl. bag, pole bag and base plate for optional pole, carry bag with drawstring. Dimensions (WxD): 250x250 cm; Pack size: 56 x 10 x 10 cm; Weight: 1.15 kg

072/673 119.95

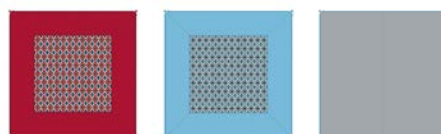

Carpet Oriental Carpet Caribbean Carpet New Zealand



Carpet Africa Carpet steel grey New Zealand

✓ For even more comfort! **from 119.95**

Carpet "Zip Carpet"

The soft, durable carpet can be combined with both the Canvas and the XL Lounger. Waterproof. Incl. carry bag. Upper material: polyester/Nylox; underside: PVC. Dimensions (LxW): 250x250 cm; Pack size: 55 x 16 x 16 cm; Weight: 2.9 kg

Carpet Oriental	072/573	119.95
Carpet Caribbean	072/574	119.95
Carpet New Zealand	072/575	109.95
Carpet steel grey		
New Zealand	072/602	109.95
Carpet Africa	072/640	119.95

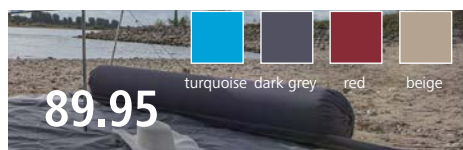

Bolster "Zip XL Lounger"

The inflatable Bent XL Lounger is a must-have for the Bent Chill Area: it either serves as a comfortable seat or just as a pillow. Connectable. Incl. carry bag. Outside material: PES. Inside material: PVC; Dimensions (LxØ): 175x30 cm; Pack size: 55 x 14 x 9 cm; Weight: 1.2 kg

red	072/576	89.95
dark grey	072/577	89.95
beige	072/641	89.95
turquoise	072/657	89.95

Pitching Pole

Four-part pitching pole. Total height: 180 cm.
steel Ø 19 mm 072/579 16.95
aluminium Ø 22 mm 072/616 24.95

Telescopic Pole

Telescopic aluminium pitching pole with a diameter of 22 or 19 mm. Height-adjustable from 130 – 230 cm. Dimensions (HxØ): 230x2.2 cm; Weight: 450 g 072/617 29.95

Bent Tensioning Pole

Adjustable aluminium connecting pole (243 – 249 cm) for the universal vehicle adapter (XL). 070/561 54.95



NEW

Vehicle Adapter

The adapter enables the Bent canvas awnings to be attached to vehicles with a 4 mm or 10 mm piping attachment. Attachment to the vehicle with connecting pole and suction cup adapter. Connection width: 235 cm. Incl. bag. Can also be attached to awnings with piping rails.

Dimensions (WxD): 250x15 cm
Piping attachment: 4 mm 072/687 79.95
Piping attachment: 10 mm 072/688 79.95

Universal Vehicle Adapter

With the universal double piping adapter (5.8 + 7.2 mm), you can attach the Canvas directly to your recreational vehicle.

Universal Vehicle Adapter
Dimensions (LxW): 250 x 15 cm; Pack size: 21 x 20 x 10 cm; Weight: 570 g 072/578 79.95

Universal Vehicle Adapter XL

Suitable for higher vehicles thanks to the 55 cm extra fabric add-on. Dimensions (WxD): 250x55 cm; Pack size: 24 x 24 x 10 cm; Weight: 810 g 072/615 89.95



✓ With Velcro to attach the expansion set



Sun Canopy Fjord

Visually appealing sun canopy with side wall option in two different sizes.

This sun canopy can be mounted in two different ways. It can be pulled into a piping rail such as the Multirail or other commercial piping rails. The second option is to attach it via a connecting pole (included in delivery). The pole is inserted into the existing hemstitches of the sun canopy and then placed in the gutter of the vehicle (see drawing). Fixed with the included clamps. Both sizes come with three pitching poles.

Material: All Weathertex 1.7, made of 100 % polyester, PU-coated, therefore extremely light; rot-, tear- and waterproof, taped seams, reinforced eyelets.

Poles: ø 19 mm steel

✓ Also perfectly equipped for rain



Keder rail



Rain gutter & sluice bar



Sun Canopy Fjord 260

Dimensions (W x H x D): 260 x 210 x 240 cm;

Pack size: 92 x 18 x 13 cm; Weight: 6.35 kg

070/130 189.95

Sun Canopy Fjord 300

Dimensions (W x H x D): 300 x 210 x 240 cm;

Pack size: 92 x 18 x 13 cm; Weight: 7.5 kg

070/131 199.95

Extension Set Fjord PR

Mounting height: 180 – 220 cm

With this extension set, you can transform the sun canopy Fjord into an awning. Simply attach the front and side walls to the inner side of the awning using the Velcro strips. The front and side walls are connected via zips. This creates a completely closed awning that protects you against rain and wind. Both side walls are equipped with transparent film windows, whereas the front wall has an additional entrance door. Incl. poles. Material: All Weather Tex.

Size 260

070/132

375.00

Size 300

070/133

385.00

without illustration: Mosquito Net for Sun Canopy Fjord

With this mosquito net, you can turn your sun canopy into an insect-free zone.

Size 260

070/134

169.95

Size 300

070/135

189.95

Gutter TOP-RAIL VW

The stylish, tried and tested gutter and fixing rail for awnings and canvas awnings is also available for the VW T5/T6/T6.1. Water runs off perfectly and conveniently along the side of the wind-screen, even with an awning attached to the vehicle.

Wind noise at higher speeds is reduced by TOP-RAIL® attached on both sides. You cannot attach roof racks to the VW T5/T6/T6.1. However, the TOP-RAIL® T5/T6/T6.1 features all the other advantages of the TOP-RAIL® T4.

The aluminium profile TOP-RAIL® T5/T6/T6.1 has been specially formed for the bodywork of the VW T5/T6/T6.1 and is therefore only suitable for these vehicles. Attachment to the T5 California would technically be possible, but Volkswagen AG does currently not allow the removal of the serial rails.

A matching spoiler set is mandatory for TÜV (MOT) approval!

for	Dimensions (W x H x D)	Weight	Item no.	Price
VW T4 (short wheelbase)	260 x 3.5 x 3 cm	2.4 kg	610/700	195.00
VW T4 (long wheelbase)	340 x 3.5 x 3 cm	3.15 kg	610/701	195.00
VW T5/T6/T6.1 (short wheelbase) left-hand	266 x 3.5 x 3 cm	2.45 kg	610/702	265.00
VW T5/T6/T6.1 (short wheelbase) right-hand	266 x 3.5 x 3 cm	2.45 kg	610/703	265.00
VW T4 right-hand	32 x 4 x 25 cm	0.1 kg	610/704	75.95
VW T5/T6/T6.1 right-hand	32 x 4 x 25 cm	0.1 kg	610/705	75.95
VW T4 left-hand	32 x 4 x 25 cm	0.1 kg	610/706	75.95
VW T5/T6/T6.1 left-hand	32 x 4 x 25 cm	0.1 kg	610/707	75.95



from 195.00



TOP-RAIL® VW



flexiMAGS Set



The smart, compact magnetic boxes with up to 102 pieces are perfect for van drivers. With flexiMAGS, you can attach objects quickly and flexibly – secure hold guaranteed. To protect the bodywork, we recommend magnet systems with a white rubber coating. Magnets and accessories for indoor and outdoor use. Be it a light, a socket, an outdoor shower or a simple clothesline – everything can be fixed quickly and securely with flexiMAGS. You also receive extensive accessories with each set, such as cable holders, metal tapes or a USB stick with application examples.

Explanation of the magnet systems:

- Magnets ø 25 mm, magnetic on both sides in plastic housing, holding force 0.4 kg each
- Magnet system 55 x 27 mm, in plastic housing, hooks, holding force 18 kg each
- Magnet system 55 x 27 mm, in plastic housing, hooks, holding force 40 kg each
- Magnet system ø 18 mm, holding force 2.5 kg each, M4 thread
- Magnet system ø 22 mm, holding force 3.8 kg each, M4 thread
- Magnet system ø 43 mm, holding force 10 kg each, M4 thread
- Magnet system ø 66 mm, holding force 25 kg each, hole for M5 screw
- Magnet system ø 88 mm, holding force 55 kg each, M6 thread
- Magnet system ø 125 mm, holding force 55 kg each, M6 thread
- Magnet system L115 mm, holding force 35 kg each, with hinge

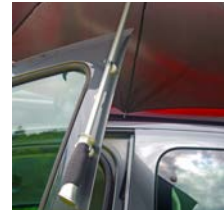

✓ 34 Parts

95.95



flexiMAGS Set Starter

Equipped with:

- 5 magnets ø 25 mm
- 2 magnet systems 55 x 27 mm, holding force 18 kg each
- 2 magnet systems 55 x 27 mm, holding force 40 kg each
- 4 magnet systems ø 22 mm
- 2 magnet systems each ø 43 mm, ø 66 mm
- Extensive accessories **610/236 95.95**

✓ 77 Parts

111.95



flexiMAGS Set Basic

Equipped with:

- 8 magnet systems each ø 18 mm, ø 22 mm
- 4 magnet systems ø 43 mm
- 2 magnet systems ø 66 mm (M6 thread)
- Extensive accessories **610/237 111.95**

✓ 102 Parts

195.95



flexiMAGS Set Classic

Equipped with:

- 4 magnet systems each ø 18 mm, ø 22 mm, ø 43 mm
- 2 magnet systems each ø 66 mm, ø 88 mm
- 1 magnet system ø 125 mm
- 1 magnet system L115 mm
- Extensive accessories **610/238 195.95**

Pole Clamp

With screw. Content: 5 pieces, ø 18 – 22 mm.

610/190 6.40



Suction Cup

Attach awnings or sun canopies to vehicles without a gutter (e.g. VW T4) by using a negative pressure suction cup. Content: 1 piece; Dimensions (Hxø): 60x100 mm

610/664 19.95



Clamping Suction Cup

For attaching the connecting pole even without a gutter or piping rail. Just clamp the pole into the suction cup and attach it to the dry and clean vehicle roof. Content: 1 piece; Dimensions (Hxø): 75x55 mm

610/665 46.90



56.95

Magnetic Adapter

Magnetic adapter consisting of 3 pieces. Allows you to attach your touring awning to your vehicle quickly. Sticks to tin roofs and is connected to the tent via piping and profiles. Dimensions (WxHxD): 260x1x17 cm **610/340 56.95**



28.95

NEW

Outwell Crosscamp Connect Set 7 – 9 mm

Adapter between Crosscamp rail and awning. The scope of delivery includes a 9 mm piping profile to connect a freestanding van awning to a vehicle with a factory-fitted Crosscamp piping rail. Connects your van awning to your vehicle. **610/341 28.95**





Rectangular Magnet flexiMAGS

Strong, rubberised magnet with M5 thread. Can be combined with flexiMAGS accessories. 2 pieces.

Holding force: 25 kg

Dimensions (LxWxH): 45x59x8.5 mm

black **610/413 25.95**

Holding force: 40 kg

Dimensions (LxWxH): 45x74x8.5 mm

black **610/414 28.95**

Holding force: 57 kg

Dimensions (LxWxH): 45x110x8.5 mm

black **610/415 45.95**



Handles/Brackets flexiMAGS

Consists of a selection of six convenient handles/brackets. **610/438 19.95**



Towel Holder Set flexiMAGS

The particularly convenient flexiMAGS magnetic towel holder set is ideal in the camper and at home. The magnetic board is simply stuck on and can be easily removed again if necessary, without drilling. Consists of 1 magnet with hook and 1 magnetic board.

Dimensions (ø): 43 mm

black **610/416 15.95**
white **610/417 15.95**



Screw Set flexiMAGS

The 59-piece stainless steel screw set consists of:

- 5 set screws M4 x 12
- 5 set screws M4 x 20
- 5 set screws M5 x 16
- 5 set screws M6 x 16
- 2 knurled nuts M4
- 2 knurled nuts M6
- 5 countersunk screws M4 x 6
- 5 countersunk screws M4 x 8
- 5 countersunk screws M5 x 12
- 5 countersunk screws M6 x 8
- 5 countersunk screws M6 x 10
- 5 hexagon nuts M4
- 5 hexagon nuts M6

610/437 28.95



Magnetic Hook flexiMAGS

Hook with high holding force to attach to your inflatable tent or the metal pole of your tent. To attach the hook to the inflatable tent, the flexiMAGS discs (ø 30 mm or ø 40 mm) are pushed under the zip of the tent.

Please note: The magnetic surface of this item is not rubberised and is therefore not compatible with the painted surface of your camper!

Dimensions (LxWxH): 53x27.5x12 mm; 2 pieces

flexiMAG-53x28

Holding force up to 18 kg.

white **610/436 6.95**

flexiMAG-53x28S

Holding force up to 40 kg.

white **610/435 16.95**



Tray Vanlett flexiMAGS

The floating tray – quickly attached, quickly removed! Flexible tray made of elegant stainless steel.

Dimensions (WxHxD): 30x8x18 cm

black **610/427 86.95**

silver **610/428 86.95**



LED Strip Set for Awnings

LED strip set, 230 V with remote control for switching the lights on and off and dimming function.

Nominal voltage: 230 V Content: 3 pieces

Dimensions (LxWxH): 120x1.5x0.6 cm; Pack

size: 121.2 x 14.5 x 6.5 cm; Weight: 1.15 kg

320/429 169.00



Dimmable

incl. remote control



+ Accessories for Dimatec

Magnetic Mounting Set for LED Strip Lights

Magnet set for attaching the Dimatec LED lamp set in inflatable tents. By inserting the magnets, which were specially developed for this purpose, into the air tube of the inflatable tent, the lamp set can be attached and provides good lighting in the tent. The set consists of: 10 plates with magnet, 2 rubberised systems ø 22 mm with cable holder, 2 discs white ø 30 mm, 1 disc ø 30 mm white with magnet and 2 cable ties (reusable).

610/446 91.95

Awning and Van – a Winning Team

Awnings mounted on the van are the ideal sun protection. Huge advantage: Once attached, they are ready for immediate use. So that you can head for your favorite sunny spot, roll out the awning and relax under it! And if you want to continue your journey, you don't waste any time – just crank it up and off you go. Seen in this way, the awning fits perfectly with the mobility that was so appreciated when traveling in a van.



Awnings

✓ The awning for vans with a pop-top roof for wall mounting



Thule Omnistor 5200

- Housing available in white, anodised or anthracite
- Length 3.15 to 4 m
- Extension 2.5 m
- Easy adjustment of the roller tube for perfect awning closing
- Exceptional stability and optimal fabric tension due to integrated tension arms (from awning length 4 m), optionally also available for awnings of length 3.5 m
- Roller tube with integrated stopper
- PVC fabric in 2 designs
- With fixing point for an optional 3rd support arm
- Front profile with gutter for dirt and water
- Robust articulated arms with double steel ropes
- Support feet with "Quick Lock System"
- Mounted via included flat adapter set or by hooking into the awning rail (not with item no. 90 981 and 90 991)



Casing colour	Awning length	Extension	Weight	Mystic Grey	Sapphire Blue	Price
anodised	3.5 m	2.5 m	28.2 kg	90 441	90 447	1,064.00
anodised	4 m	2.5 m	29 kg	90 451	90 457	1,144.00

Casing colour	Awning length	Extension	Weight	Mystic Grey	Sapphire Blue	Price
anthracite	3.15 m	2.5 m	25.4 kg	90 981	—	1,064.00
anthracite	3.5 m	2.5 m	28 kg	90 941	—	1,064.00
anthracite	3.75 m	2.5 m	27.4 kg	90 991	—	1,104.00
anthracite	4 m	2.5 m	31 kg	90 951	—	1,144.00

Wall adapters for vans	Year of construction	Length	Adapter plates	Item no.	Price
1 Adapter Fiat Ducato	1994 – 2006/06	Set	3	90 738	104.00
2 Adapter H2 Fiat Ducato	2006/07 – ...	3.15 m	1	90 751	329.00
Adapter H2 Fiat Ducato	2006/07 – ...	3.75 m	1	90 752	359.00
Adapter H2 Fiat Ducato	2006/07 – ...	4 m	1	90 753	359.00
3 Adapter H2 Lift Roof Fiat Ducato / Iveco		Set	3	89 869	172.00

📖 Main catalogue
Motor versions see main catalogue page 140!

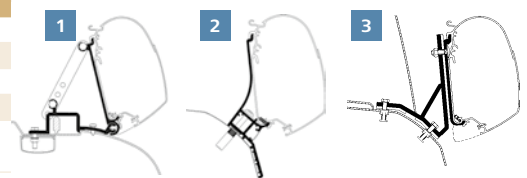

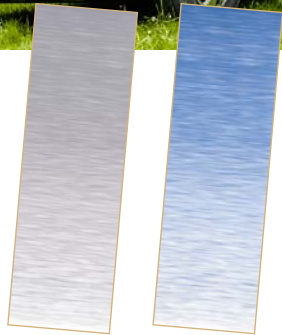

Casing colour	Awning length	Extension	Weight	Mystic Grey	Sapphire Blue	Price
white	3.25 m	2.5 m	28 kg	91 921	91 927	1,149.00
white	3.5 m	2.5 m	30 kg	91 931	91 937	1,149.00
white	3.75 m	2.5 m	33 kg	91 941	91 947	1,209.00
white	4 m	2.5 m	34 kg	91 951	91 957	1,239.00
anodised	3.25 m	2.5 m	28 kg	92 721	92 727	1,174.00
anodised	3.5 m	2.5 m	30 kg	92 731	92 737	1,174.00
anodised	3.75 m	2.5 m	33 kg	92 741	92 747	1,234.00
anodised	4 m	2.5 m	34 kg	92 751	92 757	1,264.00
anthracite	2.6 m	2 m	25 kg	92 801	—	954.00
anthracite	3 m	2.5 m	27 kg	92 811	—	1,034.00
anthracite	3.25 m	2.5 m	28 kg	92 821	—	1,174.00
anthracite	3.5 m	2.5 m	30 kg	92 831	—	1,174.00
anthracite	3.75 m	2.5 m	33 kg	92 841	—	1,234.00
anthracite	4 m	2.5 m	34 kg	92 851	—	1,264.00

Thule Omnistor 6300

- Compact articulated arm awning for roof installation
- Casing available in white, anodised or anthracite
- Extension: 2.5 m (from an awning length of 3 m)
- Individually adjustable extension-inclination angle
- Perfect stability and fabric tension thanks to integrated tensioning arms (from an awning length of 3.75 m)
- Reduced wrinkling thanks to patented fabric roll support
- Robust articulated arms with double steel cable
- Support feet with Quick Lock system
- With intake for an optional 3rd support foot (from an awning length of 3.75 m)
- Front profile with rain draining system
- Also available with 12 V motor (see main catalogue page 144)
- Motor can be retrofitted easily

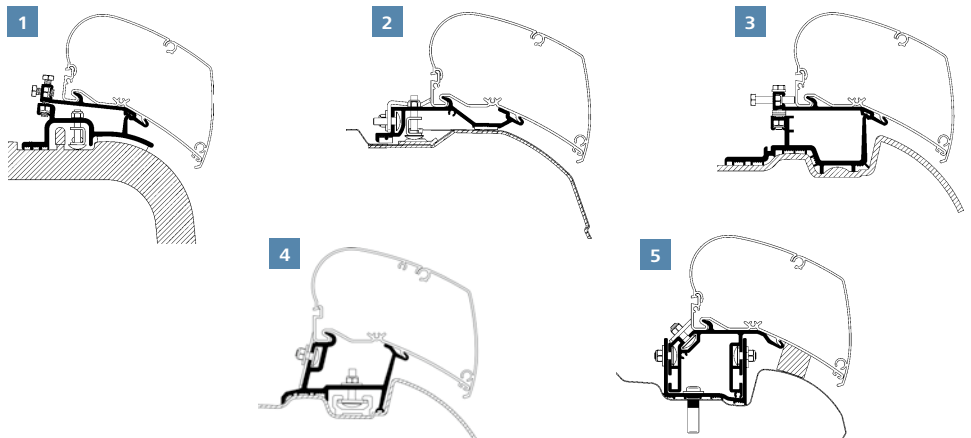

Roof adapter for vans	Year of construction	for Length	Suitable for	Adapter plates	Item no.	Price
1 Adapter Fiat Ducato	1994 – 2006/06		Roof Awnings Series 6	2	90 635	159.00
2 Adapter Fiat Ducato H2	2006/07 – ...	3.25 m	Roof Awnings Series 6	3	90 628	199.00
Adapter Fiat Ducato H2	2006/07 – ...	from 3,75 m	Roof Awnings Series 6	4	90 629	214.00
3 Adapter for Mercedes Sprinter / VW Crafter	2006/04 – ... 2006/04 – 2016		Roof Awnings Series 6	3	90 604	159.00
o. Abb.: Additional adapter for Mercedes Sprinter *	2006/04 – ...	from 3,75 m	Roof Awnings Series 6	1	90 606	77.50
4 Roof Adapter for Mercedes Sprinter **	2006/04 – ...		Roof Awnings Series 6, 9	3	90 607	159.00
5 Adapter VW Crafter / MAN TGE	2017 – ...		Roof Awnings Series 6	3	90 617	351.00

* required for the installation of an awning from a length of 3.75 m and more

** with existing roof carrier rail



Awnings

Thule Omnistor 6300 Ducato Set

Specifically designed package for the Fiat Ducato built since 07/2006, consisting of a roof awning 6300 in the fabric colour Mystic Grey, a specific adapter set and a seal strip made of EPDM foam (2 x 2 m). The awning can delivered with an anodised casing with grey or anthracite end caps. The awnings are available in the lengths 3.25 m, 3.75 m and 4 m, with an extension of 2.5 m.

- Compact articulated awning for roof installation
- Casing anodised or anthracite
- Extension: 2.5 m
- Individually adjustable inclination angle
- Perfect stability and fabric tension thanks to integrated tensioning arms (from an awning length of more than 3.75 m)
- Reduced wrinkling thanks to patented awning fabric support
- Robust articulated arms with double steel ropes
- Support feet with Quick-Lock system
- With intake for an optional 3rd support foot (for awning lengths of more than 3.75 m)
- Front profile with rain draining system
- Motor can be retrofitted effortlessly (see main catalogue page 138)

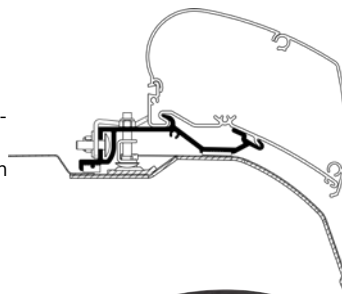

Sealing strip made of black EPDM foam



Casing colour white					
End caps	Awning length	Extension	Weight	Item no.	Price
white	3.25 m	2.5 m	31 kg	90 837	1,324.00
white	3.75 m	2.5 m	35 kg	90 838	1,374.00
white	4 m	2.5 m	36 kg	90 839	1,414.00

Casing colour anodised					
End caps	Awning length	Extension	Weight	Item no.	Price
grey	3.25 m	2.5 m	31 kg	90 804	1,349.00
grey	3.75 m	2.5 m	35 kg	90 805	1,399.00
grey	4 m	2.5 m	36 kg	90 806	1,439.00
anthracite	3.25 m	2.5 m	31 kg	90 817	1,349.00
anthracite	3.75 m	2.5 m	35 kg	90 818	1,399.00
anthracite	4 m	2.5 m	36 kg	90 819	1,439.00

Casing colour anthracite					
End caps	Awning length	Extension	Weight	Item no.	Price
anthracite	3.25 m	2.5 m	31 kg	90 821	1,349.00
anthracite	3.75 m	2.5 m	35 kg	90 822	1,399.00
anthracite	4 m	2.5 m	36 kg	90 823	1,439.00





Specifically for minivans

Awnings



from 629.00

Thule 3200

- Lightweight, manual van awning, especially designed for installation in minivans and SUVs/ CUVs
- Manual, roll-up awning
 - Length up to 3 m
 - Extension 2.5 m, also for short lengths
 - Casing optionally available in anthracite or anodised with anthracite-coloured bottom and end caps
 - Exclusive fabric tensioning system with ratchet technique for perfect fabric tension
 - Integrated tensioning arms and robust corner connections provide high stability
 - PVC fabric in mystic-grey
 - Support feet with Quick-Lock-System
 - Installation with optional adapter set directly onto the vehicle or the roof rack



Casing colour	Awning length	Extension	Weight	Item no.	Price
anodised	2.5 m	2.5 m	14.7 kg	89 966	649.00
anodised	2.7 m	2.5 m	15.6 kg	89 967	669.00
anodised	3 m	2.5 m	16.9 kg	89 968	689.00
anthracite	1.9 m	2.5 m	12 kg	89 969	629.00
anthracite	2.3 m	2.5 m	13.8 kg	89 976	649.00
anthracite	2.5 m	2.5 m	14.7 kg	89 977	669.00
anthracite	2.7 m	2.5 m	15.6 kg	89 978	689.00
anthracite	3 m	2.5 m	16.9 kg	89 979	709.00



from 779.00

Thule 4200

- Wall awning developed for Compact Vans in a sleek design for a perfect integration onto your vehicle.
- Length 2.6 or 3 m
 - Extension 2 m or 2.5 m
 - Housing in white, anodised or anthracite, fabric in Mystic Grey
 - Patented fabric roll support for a better fabric tension and reduced wrinkling
 - Perfect fixation of the support feet in the front bezel
 - Individual fabric roll adjustments ensure a perfect closing of the awning on the gearbox side
 - No risk for damage on the vehicle wall as the support feet swivel vertically out of the cover lead rail
 - Installation via flat adapters (included in standard delivery), or with special adapters for wall installation, which have to be ordered separately



Casing colour	Awning length	Extension	Weight	Item no.	Price
white	2.6 m	2 m	17.5 kg	92 542	779.00
white	3 m	2.5 m	21.8 kg	92 543	849.00
anodised	2.6 m	2 m	17.5 kg	92 538	779.00
anodised	3 m	2.5 m	21.8 kg	92 539	849.00
anthracite	2.6 m	2 m	17.5 kg	92 540	779.00
anthracite	3 m	2.5 m	21.8 kg	92 541	849.00

Information

– Suitable adapters for the awnings Thule 3200, Thule 4200 and Thule Omnistor 5102 can be found on page 15 –

Thule Omnistor 5102

Awning specially designed for Volkswagen T5/T6 Multivan and Transporter with an extension of 2 m, cloth colour Mystic Gray. The housing (cassette size 13 x 10.7 cm) has a length of 2.6 m and is available in 2 colours. It is mounted by means of special adapters in the C-rail available on the vehicle. Not suitable for vehicles with pop-top.

Casing colour	Awning length	Extension	Weight	Item no.	Price
light grey	2.6 m	2 m	19,8 kg	90 642	879.00
anthracite	2.6 m	2 m	19,8 kg	90 643	879.00



879.00

Tent Cleaner
Mild cleaning / care combination that is suitable for use on most surfaces. Does not attack rubber, acrylic glass or lacquers. Suitable for tents, awnings, etc. PE-Bottle. Capacity: 1000 ml

450/332 20.50 | 20.50

20.50



Awning Cleaner Thule PVC Cleaner
Special cleaner for fabrics; content 0.5 litres.



9.95

89 899 19.90 | 9.95

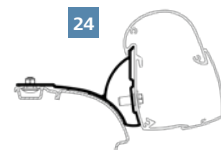
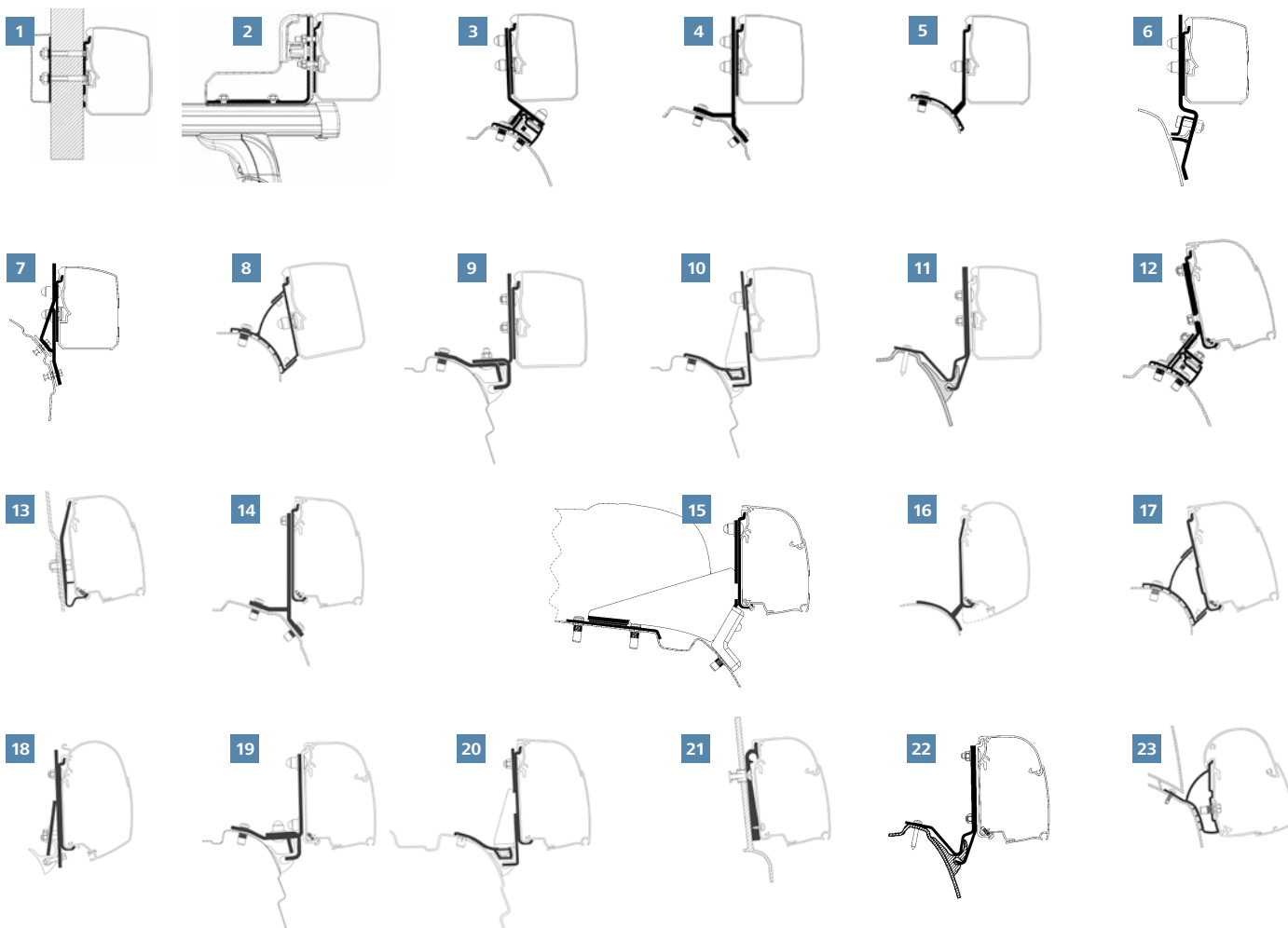

Thule 3200		Item no.	Price
1	Adapter Flat Wall	89 980	56.00
2	Adapter Roof Rack	89 981	98.00
3	Adapter PSA Minivan	89 982	169.00
4	Adapter Ford Transit / Tourneo Custom	89 983	169.00
5	Adapter Renault Trafic / Opel Vivaro / Fiat Talento / Nissan NV300	89 984	129.00
6	Adapter VW T2 / T3	89 987	159.00
7	Adapter VW T4	89 991	121.00
8	Adapter VW T5 / T6	89 985	138.00
9	Adapter VW T5 / T6 with Brandrup Rail	89 986	169.00
10	Adapter VW T5 / T6 Short Wheelbase with Reimo Multi Rail	89 988	189.00
	Adapter VW T5 / T6 Long Wheelbase with Reimo Multi Rail	89 989	197.00
11	Adapter Westfalia Kepler One / Five / Six	89 990	169.00
Thule 4200		Item no.	Price
12	Adapter PSA Minivan	92 560	169.00
13	Adapter Ford Nugget Westfalia with High Roof	89 865	101.00
14	Adapter Ford Transit / Tourneo Custom	92 561	169.00
15	Adapter MB Vito / V-Klasse with SCA Pop-up Roof	92 562	189.00
16	Adapter Renault Trafic / Opel Vivaro / Fiat Talento / Nissan NV300	89 876	129.00
17	Adapter VW T5 / T6	92 556	138.00
18	Adapter VW T5 / T6 with Brandrup Rail	89 864	113.00
19	Adapter VW T5 / T6 with Brandrup Top Rail	92 557	169.00
20	Adapter VW T5 / T6 Short Wheelbase with Reimo Multi Rail	92 558	189.00
	Adapter VW T5 / T6 long Wheelbase with Reimo Multi Rail	92 559	197.00
21	Adapter VW Westfalia	89 872	101.00
22	Adapter Westfalia Kepler One / Five / Six	92 563	169.00
Thule Omnistor 5102		Item no.	Price
23	Adapter Hymer Car 302	89 852	121.00
24	Adapter VW T5 / T6 with C-Rail	89 878	138.00

Information

Awning adapters are used to connect the awning firmly to your vehicle.

To attach a roof awning, the adapters are individually shaped – depending on the type of your vehicle – in the form of a long aluminum profile. This guarantees the perfect fit for your vehicle.

When ordering the awning, please always keep in mind to order the appropriate adapter as well.

For the installation of a wall awning, the short and universal adapter plates that are to be firmly bolted to your vehicles at a few fixed points are already included.





Thule Subsola

The modular panel system Thule Subsola for an attractive living and lounge area while camping has been developed for compact vans specifically. It provides privacy and weather protection around the Thule awning. The triangular-shaped panels can be installed very easily and, above all, very versatile: the first panel is attached to the awning. With high-quality zips, other panels can be attached at will and combined differently. An adjustable support pole allows to create more room, if necessary, or to adjust the panels to changing weather and lighting conditions. The individual doors are made of high-quality, breathing, water-resistant material and offer sight, sun and rain protection. Subsola is available as a side and front package; the packages can also be combined. If needed, individual panels and support poles can be added. The system is compatible with the following Thule awnings: Thule 4200, TO 4900, TO 5102, awning for VW California and TO 5200 with 2.6 m length and 2 m extension. A robust storage bag is included in delivery.



NEW



Thule QuickFit Ducato

Awning tent, one-piece and therefore very fast to set up, which is attached right under the awning (length 3.25 m and up) by an optionally available mounting rail. The tent, equipped with large windows, has a length of 3 m (extension 2.25 m) at a mounting height of 2.3 – 2.5 m. Made of sturdy ripstop Polyester. Incl. curtains, mud flap, tensioning material and transportation bag. **91 860 919.00**



NEW

269.00

Thule Subsola Front Pack

The large panel is attached via the Keder rail in the front rail of the awning. The other panel included in the set can be connected right or left via zips.

Scope of delivery:

- Thule Subsola Large panel
- Thule Subsola Medium panel
- Support pole
- Ropes, pegs
- Storage bag

90 121 269.00

Thule Subsola Side Pack

The medium panels are attached right or left of the awning with a tensioning pole and can be expanded with a small panel on top.

Scope of delivery:

- 2 x Thule Subsola Medium panel
- Thule Subsola Small panel
- Tensioning pole
- Support pole
- Ropes, pegs
- Storage bag

90 124 419.00

+ Accessories

w/o illustration:

Thule Subsola Medium Panel

Medium-sized panel to flexibly expand the existing panels. **90 127 129.00**

Thule Subsola Support Pole

Supports panels during the extended assembly. **90 129 69.00**

✓ Double roof Sun protection canopy

+ Accessories 29.00



Adapter Kit

Set of 8, to fix awning tents Thule QuickFit and EasyLink to awnings with piping rail facing down or forwards (e. g. older versions by Omnistor or Fiamma). **91 867 29.00**



Side Tensioning Kit

Two-piece set, fibre glass poles for additional side wall tensioning. **91 866 49.00**



49.00

Mounting Set 6200 / 6300

Consists of 3 profiles. Length 1.3 m each. **91 868 49.00**

w/o illustration: Mosquito Screen

Can be used instead of the detachable windows in the side and front panels, protecting against dirt and insects.

	Item no.	Price
side	91 883	174.00
front (2.6 m)	91 886	199.00
front (3.1 m)	91 887	209.00
front (3.6 m)	91 888	219.00



Rain Blocker G2 Side Van

Special, lightweight side panel for Fiat Ducato, extension 2.5 m, made of waterproof RAL 9002 coloured PVC. It is fixed by means of tension rafter and tensioning to the ground.



249.00

for	Vehicle model	Mounting height	Item no.	Price
Thule Omnistor 6300	Fiat Ducato H2	230 – 250 cm	91 799	249.00
Thule Omnistor 5200	Fiat Ducato H2 with pop-up roof	230 – 250 cm	90 065	249.00



THULE
SWEDEN

734.00

Rain Blocker Set for Minivans

All-in-one set for minivans with an installed Thule Omnistor 5102 or Thule 4000 with lengths 2.6 m.; installation height 1.8 - 1.99 m. It consists of 2 side panels and 2 front panels with a length of 1.27 m each. Carry bag incl. for Blocker, tensioning poles and accessories. **90 648 734.00**

Thule Residence G3 – Version for Vans –

Tent especially designed for the vehicle types Fiat Ducato with H2 roof and the Ford Transit with H3 roof, which consists of a side panel pair with 2.5 m extension, both in the colour RAL 9002. Through a clamping profile, the side panels are firmly connected to the awning fabric. The front panels are delivered with the draught skirt, which is attached to the vehicle via snaps.

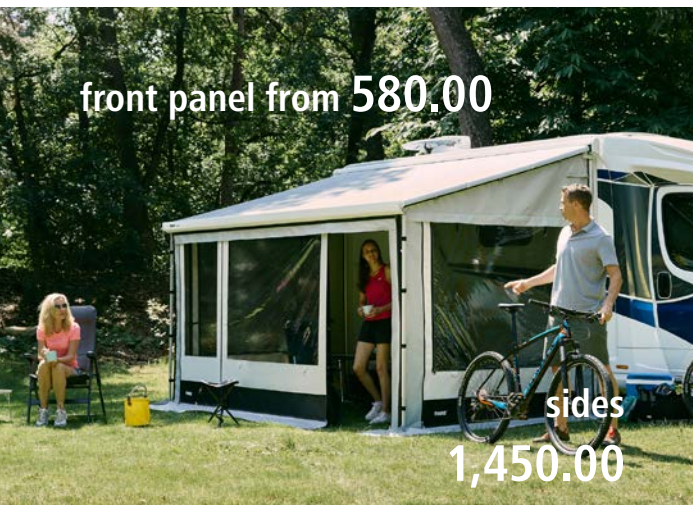

front panel from 580.00

sides
1,450.00

Alignment	Awning length	Awning type	Item no.	Price
front	3 m	TO 5200	92 061	580.00
front	3.15 m	TO 5200	92 062	630.00
front	3.25 m	TO 6300	92 063	630.00
front	3.5 m	TO 5200	92 064	630.00
front	3.75 m	TO 5200, TO 6300	92 065	680.00
front	4 m	TO 5200, TO 6300	92 066	680.00
sides Fiat Ducato, H2 – high roof		TO 5200, TO 6300	91 778	1,450.00
sides Ford Transit, H3 roof		TO 5200 NEW	91 779	1,450.00

Thule Panorama Ducato

Complete awning tent, all parts can be detached completely. The front is simply being inserted into the roof awning's front rail and firmly connected to the side walls and the awning cloth. Available for mounting heights from 2.3 to 2.5 m. Delivery includes 2 transportation bags and mud flap.

Awning length	Item no.	Price
3.25 m	91 781	2,710.00
3.75 m	91 782	2,790.00
4 m	91 783	2,790.00



from 2,710.00



Diagonal supports between mast and clamping profile increase stability.



for VW T5/T6

1,775.00

Thule Residence G3 T5/T6

Awning tent of the 3rd generation, specially designed for the utilization in combination with Thule Omnistor 5102 and the original T5 California awning. It consists of side panels and a front panel in the colour RAL9002. The window foils integrated into the side panels are equipped with mosquito nets and can be opened completely. The front panel is equipped with an entrance door on the right side. **90 644 1,775.00**

Thule Fabric Clips

These clips provide a secure attachment of the awning fabric to the awning or blocker tensioning pole to prevent the awning from flapping in the wind. The clips universally fit all aluminium Thule tensioning poles. Content: 2 pieces. **89 759 38.00**



38.00

**THULE**
SWEDEN**Thule Blocker**

The Smart Blockers do not only create additional privacy underneath the awning, they also protect from sun, rain, wind and prying eyes. They are mounted easily and can be freely combined – a perfect and individually adapted private area is the result. Thule Sun Blockers consist of translucent mesh and are available as side and front panel. Also available

are Rain and View Blockers made of wind proof PVC. Rain Blockers have a large window. All side elements fit on the left and on the right. They are mounted to the integrated piping rail by means of tensions rafters, front elements are drawn into the awnings front. They are mounted to the support legs by simple straps.

Measured from the lower edge of the awning's case to the floor.

Mounting height

Height XS	180 – 199 cm
Height S	205 – 224 cm
Height M	225 – 244 cm
Height L	245 – 264 cm



from 124.00

Thule Sun Blocker G2



from 144.00

Thule Rain Blocker G2



from 139.00

Thule View Blocker

**Protects against sun**
Thule Sun Blocker G2

Thule Sun Blockers can be mounted vertically tensioned downwards but can also be mounted diagonally for a more opened space. The lower part with tension straps remain open.



Front Length	Item no.	Price
1 m	90 021	124.00
2.4 m	90 022	149.00
2.8 m	90 023	164.00
3.3 m	90 024	179.00
3.8 m	90 025	189.00

Side panel Height	Extension	
	2 m	2.5 m
S 190 – 224 cm	90 008	—
M 225 – 244 cm	—	90 010
L 245 – 264 cm	—	90 011
	234.00	234.00

**Protects against rain**
Thule Rain Blocker G2

Thule Rain Blockers are windproof and equipped with large windows. They are mounted vertically and cover the respective area right down to the floor.



Front Height S 2.1 m		
Length	Item no.	Price
1.27 m	90 060	154.00
1.47 m	90 061	164.00
1.67 m	90 062	184.00
1.92 m	90 063	199.00

Side panel Height	Extension	
	2 m	2.5 m
XS 180 – 199 cm	90 038	—
S 205 – 224 cm	90 039	90 040
M 225 – 244 cm	—	90 041
L 245 – 264 cm	—	90 042
	249.00	249.00

Front Height M/L 2.3 m		
Length	Item no.	Price
1.02 m	90 053	144.00
1.52 m	90 054	164.00
1.72 m	90 055	184.00
2 m	90 056	199.00

Side panel Height	Extension	Price	
		Item no.	Price
S	2 m	90 029	249.00
S	2,5 m	90 030	249.00
M	2,5 m	90 031	249.00
L	2,5 m	90 032	249.00

**Privacy protection**
Thule View Blocker

View Blockers are windproof and opaque. Mounted vertically, the side panels cover the awning on one side down to the ground. Front panels can be tensioned downwards vertically or in diagonal. The part with tension straps remains open.

**Special versions**
Rain-Blocker G2

Special version for installation to a Thule 3200.

Front Length	Item no.	Price
2,4 m	89 995	139.00
2,8 m	90 006	144.00
3,3 m	89 996	149.00
3,8 m	89 997	154.00

Front Thule 3200			
Length	Height	Item no.	Price
2.5 m	1.85 m	90 092	289.00
2.7 m	1.85 m	90 093	289.00

Thule Rain Blocker Side für TO 3200

Height 180 – 199 cm **90 090** **249.00**

Rain Blocker Side for VW T4

Special version for a Thule Omnistor 2000 mounted on a VW T4. **90 099** **189.00**

Combination examples



from 34.50

Rubber Seal Strip

For all awnings of the series 5 (except 5102) and 8, for installation between the vehicle wall and

Version small			
Length	Item no		Price
2.6 m	89 711	13.27/m	34.50
3 m	89 712	13.30/m	39.90
3.5 m	89 713	13.29/m	46.50
4 m	89 714	13.25/m	53.00

the awning. Available in the versions small (width 5 cm) and large (width 8 cm).

Version large			
Length	Item no		Price
2.6 m	89 691	13.27/m	34.50
3 m	89 692	13.30/m	39.90
3.5 m	89 693	13.29/m	46.50
4 m	89 694	13.25/m	53.00



from 40.50

Rain Guard Omni-Gutter

Multi-functional, self-adhesive rain gutter for installation beneath all awnings.

Length	Item no		Price
2.6 m	89 701	15.58/m	40.50
3 m	89 702	15.63/m	46.90
3.5 m	89 703	15.57/m	54.50
4 m	89 704	15.63/m	62.50

Seal Strip

Two-piece set, length 2 m each. Seals the gap between awning of the series 6 and 9200 and the vehicle. Consists of black EPDM foam with a closed cell structure. 89 710 53.00



✓ For the right ambiance



234.00



Thule Windscreen

The windscreen with automatic roll up system, made of low-maintenance PVC fabric is 1.38 m high and extendible up to 3 m. The vehicle side mounting is done at the awning leg, by sewn-on Velcro, or it can be pitched to be free-standing with the guy ropes delivered with the product. An adapter for installation onto the vehicle in the Keder rail is included in delivery as well as a transportation bag and mounting material. Dimensions rolled up: W 10 x H 155 x D 12 cm, weight: 4.5 kg. 90 103 234.00



from 97.00

LED Lighting Strip

The flexible LED strap, which has a 3M adhesive tape on its back, spreads warm light underneath the awning. Fitted with 60 LEDs per metre, it can be easily cut every 5 cm, making it suitable for all awning lengths. The LED strap is waterproof and suitable for outdoor use, it can be simply adhered to the bottom of the awning case and connected to the on-board power system. Using a suitable dimmer (item no. 321/277, main catalogue page 529), the brightness can be adjusted; length connection cable 1 m.

Technical Data:

Power supply 12 V, power consumption max. 380 mA per metre, light intensity up to 300 lumen.

Length	Alignment	Item no.	Price
4 m	bottom	89 798	97.00
4 m	lateral	89 801	127.00

from 119.00

Tent & LED Mounting Rail Thule Omnistor 5200

To mount a Thule QuickFit awning to a Thule Omnistor awning 5200. The rail is clamped to the bottom edge of the awning cassette without drilling. Apart from the Keder intake for the tent, the mounting rail offers additional space to install an optional Thule LED strip.

Length	white	anthracite	Price
3 m	89 811	89 821	119.00
3.5 m	89 812	89 822	119.00
4 m	89 813	89 823	129.00

62.00

Tent & LED Mounting Rail Thule Omnistor 6200 / 6300 / 9200

Matches the design for the Thule Omnistor 5200, but includes 3 rails, each 1.3 m long, color anthracite. Only suitable for the LED light strip with lateral light emission (item no. 89 801). 89 828 62.00



Tips & tricks

To avoid any bad surprises later on, you should fully extend your awning once before travelling and check for dirt (which can lead to holes in the long run).

It is also advised to "practice" setting up the side and front walls in the comfort of your home.

from 869.00



Dometic PW 1100

Robust and inexpensive wall awning – ideal for Camper Vans

- Compact housing without visible screws
- Robust awning fabric made of one piece – no seam, colour grey
- Support feet with patented Slide-Out system for comfortable handling and Easy Lock Flipper – preventing accidental dropping
- Lengths from 2.6 – 3.75 m, extension 2.5 m (from length 3 m and up)
- Telescopic crank
- Housing colour anthracite

NEW



Set-Price
from 1,389.00

Sets for Pössl Vehicles with Skyroof

Suitable for Pössl vehicles built since 2006/07.



Awning length	Extension	Weight	Item no.	Price
2.6 m	2 m	21 kg	95 131	869.00
3 m	2.5 m	24 kg	95 141	955.00
3.75 m	2.5 m	28 kg	95 181	985.00

Dometic PR 2000 Ducato / Pössl Set

The PR 2000 in the lengths 3.25 m, 3.75 m and 4 m (casing colour anthracite) is also available as an inexpensive set price for the Fiat Ducato, vehicles identical in construction built since 07/2006, and for Pössl vehicles with Skyroof. The set consists of awning, mounting adapter and sealing tape.

Information

The vehicle-specific adaptors for roof installation is tripartitely, the sealing band water from intruding into the vehicle via the sliding door.

– All components have to be ordered separately! –

Seal Strip

Two-piece set, length 1.5 m each. Seals the gap between awning and vehicle.



Adapter for Fiat Ducato H2

Suitable for Fiat Ducato, Peugeot Boxer and Citroen Jumper built since 2006/07.



Sets for Fiat Ducato and Vehicles Identical in Construction Built since 2006/07

Awning length	Extension	Weight	Item no.	Price	Adapter	Price	Item no.	Price	Set Price
3.25 m	2.5 m	23 kg	95 930	1,169.00	94 700	165.00	94 690	55.00	1,389.00
3.75 m	2.5 m	27 kg	95 950	1,249.00	94 700	165.00	94 690	55.00	1,469.00
4 m	2.5 m	29 kg	95 960	1,279.00	94 700	165.00	94 690	55.00	1,499.00

Sets for Pössl Vehicles with Skyroof

Awning length	Extension	Weight	Item no.	Price	Adapter	Price	Item no.	Price	Set Price
3.25 m	2.5 m	23 kg	95 930	1,169.00	94 724	199.00	94 690	55.00	1,423.00
3.75 m	2.5 m	27 kg	95 950	1,249.00	94 724	199.00	94 690	55.00	1,503.00
4 m	2.5 m	29 kg	95 960	1,279.00	94 724	199.00	94 690	55.00	1,533.00

– All components have to be ordered separately! –



DOMETIC

OUTDOOR

Complete profile

Roof Adapter for Dometic Awnings PR 2000

Vehicle model	Year of construction	Length	Adapter plates	Item no.	Price
1 Fiat Ducato type 250/ 290	2006/07 – ...	3.25 m	1	94 707	299.00
	2006/07 – ...	3.75 m	1	94 708	315.00
Fiat Ducato type 250/ 290	2006/07 – ...	4 m	1	94 709	315.00
2 Mercedes Sprinter/ VW Crafter	2006/04 – ... 2006/04 – 2016	Set	3	94 716	189.00
3 VW Crafter/ MAN TGE	2017 – ...	Set	2	94 717	289.00
4 Renault Master III	2010/04 – ...	3.25 m	1	94 719	279.00

Wall adapter for Dometic awnings PW 1100 and PW 1500

Vehicle model	Year of construction	Length	Adapter plates	Item no.	Price
5 Fiat Ducato H2 with retractable roof	2006/07 – ...	Set	2	94 790	225.00
6 Fiat Ducato H3	2006/07 – ...	Set	4	94 791	159.00
7 VW T5/ T6 Multivan		Set	2	94 786 NEW	149.00
8 VW T5/ T8 Multivan with C-rail		Set	2	94 787 NEW	169.00
9 VW California		Set	2	94 797 NEW	149.00
10 PSA Minivan		Set	2	94 799	219.00

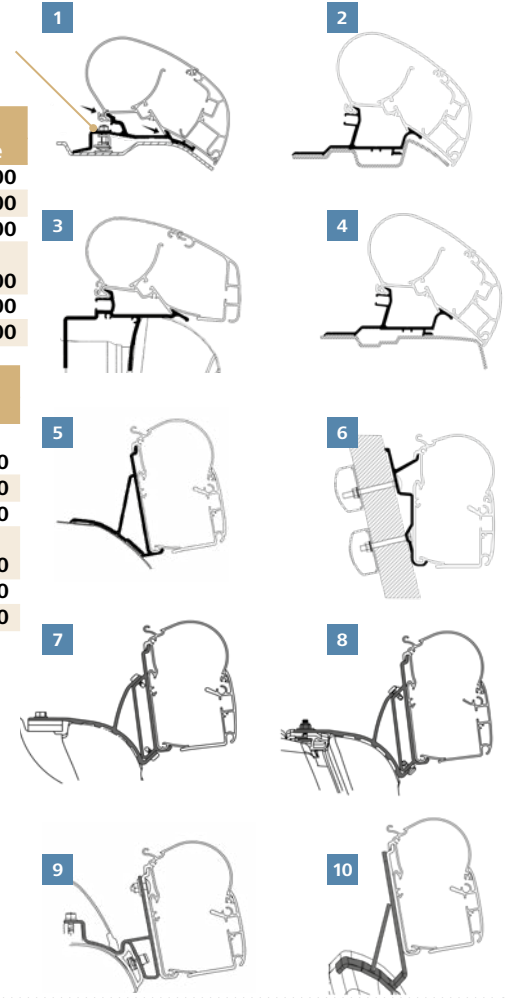

Accessories

Dometic Tiedown Kit

Tensioning system to safely anchor Dometic awnings to the ground. Adjustable guy ropes with plastic claps offer secure hold, integrated spiral springs relieve pressure from the awning if the weather is windy. **94 682 26.00**

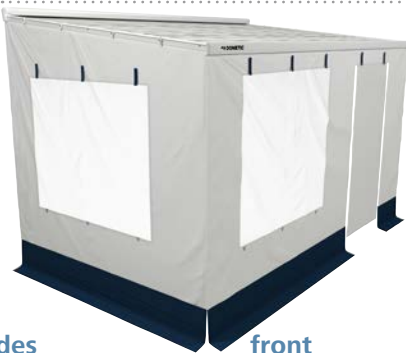

sides from 1,129.00 front from 545.00

Dometic CampRoom

- Suitable for Dometic awnings PW 1100, PW 1500 and PR 2000 with a length from 3 – 4 m and an extension of 2.5 m
- Extremely fast and simple mounting – only one person is necessary
- Lightweight

CampRoom	Side Panel Pair	Height	Item no.	Price
PW 1100	M		94 612	1,129.00
PR 2000	M		94 617	1,175.00
PW 1100	L		94 613	1,175.00
PR 2000	L		94 618	1,229.00

- As standard with mosquito net and roll-up PVC windows
- Side panels available in 2 sizes: Medium (2.3 – 2.59 m) and large (2.6 – 2.89 m) – measured from the bottom of the casing to the ground
- Special side panels for Fiat Ducato from 07/2006 (item no. 94 622)
- Front panel fits both heights

Dometic CampRoom	Front Panel	Item no.	Price
3 m		94 601	545.00
3.25 m		94 602	575.00
3.5 m		94 603	575.00
3.75 m		94 604	625.00
4 m		94 605	625.00

CampRoom Side Panels Ducato

Special version for Dometic awnings PR 2000 mounted to a Fiat Ducato built since 07/2006.

94 622 1,239.00

Dometic SunProtect

- Suitable for Dometic awnings PW 1100, PW 1500 and PR 2000 lengths 3 – 4 m with an extension of 2.5 m
- Transparent fabric mesh, translucent and heat-repellent
- Front height 1.4 m
- Delivery includes tensioning material
- Side panel universally fitting left and right

SunProtect Side	Height	Item no.	Price
M	230 – 259 cm	94 642	215.00
L	260 – 289 cm	94 643	225.00

SunProtect Front	Item no.	Price
3 m	94 631	149.00
3.5 m	94 633	169.00
3.75 m	94 634	189.00
4 m	94 635	189.00



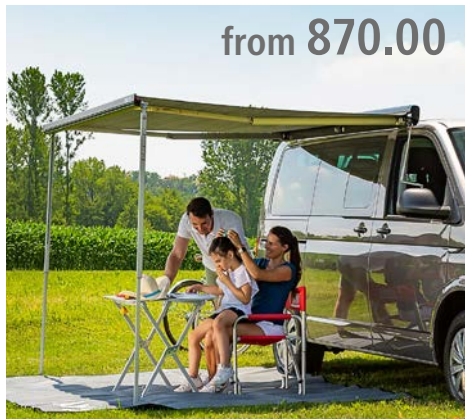

from 870.00

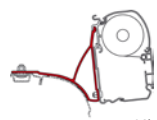

Kit VW T5/T6 – Multivan

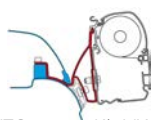

Kit VW T5/T6 – California

Awning Fiammastore F45s VW T5/T6

The F45s 260/300 VW T5/T6 are delivered with the installation adapters as standard. Installation without drilling. With the T5/T6 California, adapters are screwed onto the original points. For the T5/T6 Multivan, the original aluminium rail of the VW is required. The Privacy Room VW T5/T6 can be retrofitted.

Scope of delivery: adapter Multivan or California
Fabric colour: Royal Grey; **Extension:** 200 cm

F45s 300

Awning length: 308 cm Weight: 22 kg;
Vehicle model: VW T6, Multivan, 2015 – ..., VW T6 (incl. T6.1), transporter, 2016 – ..., VW T5, transporter, 2003 – 2015, VW T5, Multivan, 2003 – 2015

Casing colour	Item no.	Price
titanium	071/958	909.00
black	071/986	909.00

F45s 260

Awning length: 263 cm
Weight: 19.5 kg

Vehicle model: VW T5, California, 2003 – 2015, VW T6, California, 2015 – ...

Casing colour	Item no.	Price
polar white	071/971	870.00
titanium	071/957	870.00
black	071/968	870.00

Vehicle model: VW T6, Multivan, 2015 – ..., VW T6 (incl. T6.1), transporter, 2016 – ..., VW T5, transporter, 2003 – 2015, VW T5, Multivan, 2003 – 2015

Casing colour	Item no.	Price
titanium	071/956	879.00
black	071/959	879.00



893.00

Awning Fiammastore F45s PSA

The classic, compact wall awning

Awning F45s complete with mounting brackets, especially suitable for PSA minivans. Also suitable for vehicles with pop-top. The awning is perfectly integrated into the vehicle and can be installed without additional rails or work inside the vehicle.

Scope of delivery: awning, mounting bracket, crank handle

Vehicle model: Toyota ProAce Verso (Gen. 2), Peugeot Traveller, Citroën SpaceTourer, Opel Zafira Life Generation 1, 03/2019 – ...

Dachform: H1 – normal roof **Fabric colour:** Royal Grey; **Awning length:** 263 cm; **Extension:** 200 cm; **Weight:** 19.5 kg

Casing colour	Item no.	Price
polar white	071/649	893.00
black	071/651	913.00



956.00



Royal Grey

Fiamma Awning F40van

The awning fits perfectly to your van due to lower holders. The reinforced arms with reduced profile do not affect the opening and closing of the side door when the awning is in use.

Installation: suitable for minivans without a pop-top.

Gearbox: left-hand side, **Casing colour:** black
Fabric colour: Royal Grey

Awning length: 210 cm
Extension: 150 cm; **Weight:** 17 kg

NEW

071/824 876.00

Awning length: 270 cm
Extension: 225 cm; **Weight:** 19 kg

071/109 956.00



904.00

new size

**FIAMMA**
home is everywhere

For awning length 270 cm
Weight: 5.4 kg 071/061 904.00

Awning Tent Fiamma Room Van Premium

The functional and comfortable Privacy for the F40van and the F43van awning. Equipped with a door and rollable side windows with mosquito nets. In combination with the F40van or the F43van awning, it is ideal for short stays.

- Light, without poles
- Quick to set up due to direct attachment to the articulated arms and the front cover of the awning
- Roof, front and side parts made of one piece
- Front wall with window and rollable blackout
- Compact pack size incl. bag

Awning not included in delivery!

F40van, F43van; **Mounting height:** 180 – 210 cm;
Extension: 225 cm

NEW

For awning length 300 cm
Weight: 5.8 kg 071/836 1,020.00



Awning Fiamma F43van

Wall awning with magnetic crank, special version developed for vans, also with pop-top. Compact and with an innovative design that harmonises with the look of the vehicle, be it with or without pop-top.

Features:

- Opening via winch with magnetic catch in the end cap, convenient position due to the mounting height of the awning on the van
- Awning opening with negative inclination to utilise the entire space at maximum height (2.20 m)
- LED device in the housing, which is visible even when the awning is closed; recessed front panel lock
- Two concealed piping rails, one in the front panel, the other in the housing (for attaching the Room Van Premium awning)
- One-piece front panel fastener and support foot bracket

- The compact shape reduces the maximum height and makes it possible to enter car parks even with the awning fitted.
- Length 270 with 225 cm extension, 300 with 250 cm extension
- Compatible with F40van accessories: front walls, Room Van Premium and Rafter LED Van (only for length 270)

Casing colour: black

Fabric colour: Royal Grey

Awning length: 270 cm

Extension: 225 cm; **Weight:** 19 kg

071/820 810.00

Awning length: 300 cm

Extension: 250 cm; **Weight:** 21.5 kg

071/821 884.00

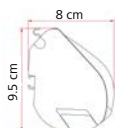

Awning Fiamma F35pro

Fiamma F35pro is a convenient awning with a manual mechanism and telescopic legs integrated into the roll. It can be installed on any kind of mini-van, thanks to a variety of brackets that can be attached to the wall, roof bars, and rails. Due to the double piping rail, two front parts or additional accessories can be mounted at the same time. The case is made from light, sturdy aluminium. The awning is made from waterproof, translucent vinyl. Max. height from the ground: 225 cm. Fabric colour: Royal Grey

Casing colour black



	Awning length	Weight	Item no.	Price
F35pro 180	183 cm	8.5 kg	071/617	501.00
F35pro 220	223 cm	10.5 kg	071/618	552.00
F35pro 250	253 cm	11.5 kg	071/954	572.00
F35pro 270	273 cm	13 kg	071/955	575.00
F35pro 300	303 cm	14 kg	071/619	599.00

Casing colour titanium



	Awning length	Weight	Item no.	Price
F35pro 220	223 cm	10.5 kg	071/987	552.00
F35pro 270	273 cm	13 kg	071/952	575.00
F35pro 300	303 cm	14 kg	071/953	599.00



88.00

+ Accessories

NEW

Awning Light Kit Strip Awning F43van

LEDs for the front panel and housing, for maximum illumination. The kit consists of a self-adhesive LED strip.

Replacement of the LED strip with the COB* LED strip, which guarantees a better, homogeneous light distribution. Neutral 4000 K light for better ambient lighting, also excellent for reading and relaxing.

* Chip On Board. COB LED strips are LED strips that produce homogeneous lines of light without the classic dotted effect. Nominal voltage: 12 V; Nominal capacity: 27 W; Luminous flux: 2558 lm; Length: 2.5 m; Weight: 300 g

071/748 88.00



+ Accessories

12.00

Safety Strip

Optional safety accessories for F35pro awnings consisting of a 39 cm long belt with a respective slider. For more safety on uneven roads.

071/809 12.00





from 785.00



wall awning

This is how the high roof works

Fiammastore F45 S

The perfect addition for relaxing moments outside.

Enjoy a holiday without any worries with this innovative Fiamma awning with various accessories and excellent quality.

The advantages of the Fiammastore F45

- Aluminium housing
- Gutter in front panel
- Double piping rail in front panel
- Cable fixture in arms
- Cloth is always perfect thanks to support roll
- Reinforced bracket
- Smooth and quiet extension
- Elegant design, very sturdy, easy and safe to use
- Easy to clean
- Quiet when in use and while driving
- Easy to hook in gear eyelet
- Maximum shade
- Regulation system for closing the front panel
- Self-locking Auto-Lock security mechanism
- Pins that indicate that the front panel is closed properly

Awning type: Elegant aluminium housing. Wall mounting. For motorhomes, caravans and vans.

Cloth: UV-resistant, waterproof vinyl printed on both sides

Technical data: Presto Fix® regulation system, reinforced and space-saving articulated arms with double rope tensioning. Dual Shock-Absorber, Auto-Lock, Dual Security, folding awning crank, Short for F45s 260 cm, standard brackets AS (included), ground spikes; 1 Rafter tensioning pole made of anodised aluminium (included from a length of 400 cm on).

Frame: Made of extra strong Alu-Lite. Lightweight housing in Polar White, Titanium or Deep Black.

Fiammastore® F45 S Polar White



	Awning length	Extension	Weight	Royal Grey	Price
F45 S 230	231 cm	150 cm	16.5 kg	071/870	785.00
F45 S 260	263 cm	200 cm	19.5 kg	071/871	813.00
F45 S 300	308 cm	250 cm	23 kg	071/872	896.00
F45 S 350	348 cm	250 cm	25 kg	071/873	987.00
F45 S 375	375 cm	250 cm	26 kg	071/929	1,041.00
F45 S 400*	398 cm	250 cm	27 kg	071/874	1,059.00
F45 S 425*	423 cm	250 cm	28.2 kg	071/989	1,185.00

Fiammastore® F45 S Deep Black



	Awning length	Extension	Weight	Royal Grey	Price
F45 S 230	231 cm	150 cm	16.5 kg	071/856	812.00
F45 S 260	263 cm	200 cm	19.5 kg	071/881	840.00
F45 S 300	308 cm	250 cm	23 kg	071/882	917.00
F45 S 325	325 cm	250 cm	24 kg	071/853	960.00
F45 S 350	348 cm	250 cm	25 kg	071/883	1,005.00
F45 S 375	375 cm	250 cm	26 kg	071/857	1,058.00
F45 S 400*	398 cm	250 cm	27 kg	071/884	1,088.00
F45 S 425*	423 cm	250 cm	28.2 kg	071/858	1,207.00

*) Incl. 1 Rafter tensioning pole made of anodised aluminium!

Accessories (optional): Privacy® Room awning; Blocker; Rafter Pro; Motor Kit; mounting bracket; hand crank and Rain-Guard rain protection seal; Tie-Down; Kit Awning Hangers and spoiler; LED.



92.95

BRUGGER
MAGNETSYSTEMEMADE IN
GERMANY

Magnetic Awning Bracket Set flexiMAGS

The awning foot bracket allows you to attach your awning directly to your van. Perfect for short stops or on surfaces that make using pegs impossible. Suitable for wall and roof awnings.

Scope of delivery: 2 x magnet A system, rubber-coated, 125 mm, with threaded pin M6 x 28 mm and knurled nut M6.

Dimensions: ø 12.5 cm

Weight: 220 g

071/999

92.95



99.00

multiAnker 2.0

The multiAnker 2.0 consists of 2 suction cups (traction force 70 kg each), with which the awning support feet can be fitted to the motorhome, van or caravan. It is used on awkward grounds, such as asphalt sites, for example! The installation is carried out without any changes to the vehicle and is safe and easy to perform thanks to the stable lever mechanism. multiAnker 2.0 is compatible with the awnings by Thule Omnistor, Fiamma and Dometic. **90 070 99.00**

multiAnker
powered by

Accessories Adapter, 2 pieces

Two-piece set, thanks to the central M6 thread, it is possible to easily and quickly attach self-made accessories. **90 078 15.00**



15.00

Awning Adapters

F45s

 Webshop / main catalogue

You can find more adapters in our webshop and in our main catalogue.

home is everywhere

	Vehicle model	Item no.	Price
Kit Combi Rail Bracket – Brandrup	VW T5, 2003 – 2015, VW T6 (incl. T6.1), 07/2015 – ...	071/080	99.00
Kit Ducato 2006 (High Roof)	Fiat Ducato X250/X290, Citroën Jumper X250/X290, Peugeot Boxer 250/290, 2006 – today	071/658	99.00
Kit Sprinter H3	Mercedes-Benz Sprinter W906, 04/2006 – 2018, VW Crafter Generation 1, 2006 – 11/2016	071/679	106.00
Kit Ford Transit (High Roof)	VW Caddy Type 2K, 10/2003 – 06/2015, Mercedes-Benz Sprinter W906, 04/2006 – 09/2013, Ford Transit Generation 6, 06/2006 – 2014	071/652	84.00
Kit Van	Citroën C25 280/290, 1982 – 1994, Fiat Ducato 280/290, 01/1982 – 05/1994, Ford Transit Generation 5, 2000 – 2006, Peugeot J5 280/290, 1982 – 1994, Mercedes-Benz Sprinter W901 – W905, 1995 – 03/2006, Ford Transit Generation 6, 06/2006 – 2014	071/170	124.00
Kit VW T5/T6 Multivan Transporter	VW T6 (incl. T6.1), 2016 – ..., VW T5, 2003 – 2015, VW T6, 2015 – ...	071/132	110.00
Kit Renault Trafic	Nissan NV300, 2016 – ..., Fiat Talento, 2016 – ..., Renault Trafic III, 09/2014 – ...	071/120	97.00
Kit Renault Master H2	Nissan Interstar, 2002 – 2010, Opel Movano A, 1998 – 2010, Renault Master II, 1997 – 2010	071/160	157.00
Kit V-Class Marco Polo built since 2014	Mercedes-Benz V-Class W447, 2014 – ...	071/121	249.00
Kit Fiat Ducato Hymercar, Pössl H2 (Pop-Top)	Fiat Ducato X250/X290, H2 Skyroof, 06/2006 – ..., Hymer Car, Pössl	071/804	181.00
Kit Ford Custom Nugget Lift Roof	Westfalia Ford Nugget, 2014 – ...	071/157	255.00
Kit VW T5/T6 Multivan Transporter Deep Black	VW T6 (incl. T6.1), 2016 – ..., VW T5, 2003 – 2015, VW T6, 2015 – ...	NEW 071/731	126.00
Kit VW T5/T6 Pop-Top	VW T6 (incl. T6.1), 07/2015 – ..., VW T5, 2003 – 06/2015	NEW 071/733	107.00
Kit Ford Transit L3 H3	Ford Transit Generation 7, 2014 – ...	NEW 071/743	183.00

F40

	Vehicle model	Item no.	Price
Kit Combi Rail Bracket – Brandrup	VW T6 (incl. T6.1), 2016 – ..., VW T5, 2003 – 2015, VW T6, 2015 – ...	071/081	113.00
Kit Ford Custom L1 H1 – normal roof	Ford Transit Custom, L1, 2012 – ...	071/146	248.00
Kit Ford Custom L2 H1 – normal roof	Ford Transit Custom, L2, 2012 – ...	071/275	239.00
Kit Mercedes V-Class	Mercedes-Benz V-Class W447, 2014 – ...	071/234	301.00
Kit Renault Trafic H1 – normal roof	Renault Trafic III, L1, 2014 – ...	071/279	211.00
Kit Mercedes Vito Jules Verne	Westfalia Jules Verne (MB Vito), 2017 – ...	071/808	121.00
Kit Renault Trafic	Renault Trafic III, L2, 2014 – ...	071/281	288.00
Kit VW T5/T6	VW T6 (incl. T6.1), 07/2015 – ..., VW T5, 2003 – 06/2015	071/625	119.00
Kit VW T5/T6 Roof Rail	VW T6 (incl. T6.1), 07/2015 – ..., VW T5, 2003 – 06/2015	NEW 071/740	109.00
Kit VW T5/T6 Multirail Reimo	VW T6 (incl. T6.1), 2016 – ..., VW T5, 2003 – 2015, VW T6, 2015 – ...	071/083	130.00
Kit VW Caddy Maxi Lift Roof	VW Caddy IV, 06/2015 – 02/2020	071/127	137.00
Adapter PSA	Toyota ProAce Verso (Gen. 2), Peugeot Traveller, Citroën SpaceTourer, Opel Zafira Life Generation 1, 03/2019 – ...	071/138	403.00

F43

	Vehicle model	Item no.	Price
Kit Ford Custom Lift Roof Deep Black H1 – normal roof	Ford Custom, 2012 – ...	NEW 071/735	164.00
Kit Renault Trafic Deep Black	Nissan NV300, 2016 – ..., Fiat Talento, 2016 – ..., Renault Trafic III, 09/2014 – ...	NEW 071/738	97.00
Kit VW T5/T6 Pop-Top Deep Black	VW T6 (incl. T6.1), 07/2015 – ..., VW T5, 2003 – 06/2015	NEW 071/734	107.00
Kit VW T5/T6 Multivan Transporter Deep Black	VW T6 (incl. T6.1), 2016 – ..., VW T5, 2003 – 2015, VW T6, 2015 – ...	NEW 071/732	126.00

F35

	Vehicle model	Item no.	Price
Kit Car		071/814	103.00
Kit Mercedes Viano, Marco Polo	Mercedes-Benz Viano W639/V639, 07/2003 – 07/2014, Mercedes-Benz Vito W639/V639, 07/2003 – 07/2014	071/810	105.00
Kit Renault Trafic	Nissan NV300, 2016 – ..., Fiat Talento, 2016 – ..., Renault Trafic III, 09/2014 – ...	071/124	94.00
Kit Renault Trafic, Opel Vivaro	Renault Trafic II, 2001 – 08/2014, Nissan Primastar, 2002 – 2016, Opel Vivaro A, 2001 – 07/2014	071/811	89.00
Kit VW T5/T6 California	VW T5, 2003 – 2015, VW T6, 2015 – ...	071/813	101.00
Kit VW T5/T6 Multivan/Transporter with C-Rail	VW T6 (incl. T6.1), 07/2015 – ..., VW T5, 2003 – 06/2015	071/812	96.00
Kit VW T5/T6 Multivan/Transporter without C-Rail	VW T6 (incl. T6.1), 2016 – ..., VW T5, 2003 – 2015, VW T6, 2015 – ...	071/130	112.00
Adapter Kit PSA	Toyota ProAce Verso (Gen. 2), Peugeot Traveller, Citroën SpaceTourer, Opel Zafira Life Generation 1, 03/2019 – ...	071/231	145.00



from 957.00

**Fiammastore® F80 S Polar White**

	Awning length	Cloth width	Extension	Weight	Royal Grey	Price
F80 S 290	290 cm	278 cm	200 cm	27 kg	071/020	957.00
F80 S 320	320 cm	308 cm	250 cm	29 kg	071/021	1,075.00
F80 S 340	340 cm	328 cm	250 cm	30 kg	071/022	1,091.00
F80 S 370	370 cm	358 cm	250 cm	32 kg	071/023	1,140.00
F80 S 400*	400 cm	388 cm	250 cm	34 kg	071/024	1,173.00
F80 S 425*	425 cm	412 cm	250 cm	35 kg	071/025	1,240.00

Fiammastore® F80 S Titanium

	Awning length	Cloth width	Extension	Weight	Royal Grey	Price
F80 S 290	290 cm	278 cm	200 cm	27 kg	071/070	983.00
F80 S 320	320 cm	308 cm	250 cm	29 kg	071/071	1,100.00
F80 S 340	340 cm	328 cm	250 cm	30 kg	071/072	1,116.00
F80 S 370	370 cm	358 cm	250 cm	32 kg	071/073	1,157.00
F80 S 400*	400 cm	388 cm	250 cm	34 kg	071/074	1,207.00
F80 S 425*	425 cm	412 cm	250 cm	35 kg	071/075	1,272.00

Fiammastore® F80 S Deep Black

	Awning length	Cloth width	Extension	Weight	Royal Grey	Price
F80 S 290	290 cm	278 cm	200 cm	27 kg	071/090	983.00
F80 S 320	320 cm	308 cm	250 cm	29 kg	071/091	1,100.00
F80 S 370	370 cm	358 cm	250 cm	32 kg	071/093	1,157.00
F80 S 400*	400 cm	388 cm	250 cm	34 kg	071/094	1,207.00
F80 S 425*	425 cm	412 cm	250 cm	35 kg	071/098	1,272.00

* from size 400 including 1 Rafter tensioning pole made of anodised aluminium!

Adapters F80s

	Vehicle model	Item no.	Price
Kit Fiat Ducato	Fiat Ducato 230, 03/1994 – 04/2002, Fiat Ducato 244, 04/2002 – 2006	071/474	115.00
Kit Fiat Ducato High Roof	Fiat Ducato 230, 03/1994 – 04/2002, Fiat Ducato 244, 04/2002 – 2006	071/475	108.00
Kit Ducato H2 Skyroof	Fiat Ducato X250/X290, H2 Skyroof, 06/2006 – ...	071/629	167.00
Kit Fiat Ducato H3	Citroën Jumper 250/290, Fiat Ducato X250/X290, Peugeot Boxer 250/290 2006 – today	071/476	146.00
Kit Fiat Ducato H2 silver	Citroën Jumper 250/290, Fiat Ducato X250/X290, Peugeot Boxer 250/290 2006 – today	071/626	170.00
Kit Fiat Ducato H2 black	Citroën Jumper 250/290, Fiat Ducato X250/X290, Peugeot Boxer 250/290 2006 – today	071/627	205.00
Kit Fiat Ducato High Roof Super Long	Citroën Jumper 250/290, Fiat Ducato X250/X290, Peugeot Boxer 250/290	071/628	202.00
Adapter Ford Transit H3		071/148	389.00
Adapter Ford Transit L3 H3	Ford Transit Generation 7, 2014 – ...	071/637	219.00
Adapter Ford Transit Van L2	Ford Transit, all models built since 2013	NEW 071/741	219.00
Adapter Ford Transit Van L3	Ford Transit, all models built since 2013	NEW 071/742	219.00
Kit Mercedes Sprinter/VW Crafter High Roof	Mercedes-Benz Sprinter W906, 04/2006 – 2018, VW Crafter Generation 1, 2006 – 11/2016, Dodge Sprinter, Freightliner Sprinter, 2006 – ...	071/657	162.00
Kit Mercedes Sprinter	Mercedes-Benz Sprinter W906, 04/2006 – 2018	071/659	140.00
Kit Renault Master H2	Nissan Interstar, 2002 – 2010, Renault Master III, 2010 – ..., Opel Movano A, 1998 – 2010	071/479	140.00
Kit Renault Master H2 built since 2010	Opel Movano B, 2010 – 04/2021, Renault Master III, 2010 – ..., Nissan NV400, 2010 – 2021	071/472	157.00
Kit VW Crafter built since 2017	VW Crafter Generation 2, 11/2016 – ..., MAN TGE, 2017 – ...	071/653	
Kit VW Crafter/MAN L3 H3 with out Roof Rail	VW Crafter Generation 2, 11/2016 – ..., MAN TGE, 2017 – ...	071/829	363.00

**Fiammastore® F80 S****The awning for every type of roof installation.**

- Compact cross-section for optimum adaptation to the shape of your vehicle
- Device for installing an LED strip light in the front panel and on the housing
- Triple piping rail in the front panel
- Aluminium end caps for maximum resistance
- Opened and closed with a crank, motor available as accessory
- Ideal for motorhomes, caravans and vans

Installation type: roof installation.**Colours & materials:** housing made of extra strong aluminium in Polar White, Titanium or Deep Black. Multi-layer cloth, waterproof and UV-resistant, printed on both sides. Made of vinyl.**Accessories** (not included): vehicle adapter, Privacy Room, front and side panels Blocker and Side to complete the system.**Tips & tricks**

To avoid any bad surprises later on, you should fully extend your awning once before travelling and check for dirt (which can lead to holes in the long run).

It is also advised to "practise" setting up the side and front walls at home.



✓ Also suitable for the F65.

Awning Tent Privacy Room F80

With the Privacy Room F80/F65, you can transform your Fiammastore into a cosy living space. The awning and the side walls can be connected quickly using the patented Fast Clip. The awning fabric is clamped between the lower and upper profiles and closed by means of clamps inside the Privacy Room. A special vertical padding is located in the rear part of the side walls and is pressed against the awning by a telescopic aluminium rod. The front of the Privacy Room is pulled into the rail of the front wall and connected to the side walls of the Privacy Room via zips. The two side windows and the front window can be opened. All elements are equipped with a mosquito net and large Velcro strips for closing the window completely.

The Privacy Room F80 is available in the following versions: Privacy Room 300 Ducato (and similar), Privacy Room 300 H3 (e.g. MB Sprinter and others), Privacy Room 300 H (e.g. caravan height 245 – 280 cm), Privacy Room 300 XL (awning extension 275 cm, height 245 – 280 cm) and Privacy Room 300 XXL (awning extension 275 cm, height 281 – 310 cm).

Front wall: If your awning is 320 cm long or longer, you need the Privacy Room 300. In this case, you also need a front wall extension, the size of which depends on the length of your awning.

Scope of delivery: front wall with roll-up window, mosquito net and door that can be attached either on the right or on the left side. Two side walls with roll-up windows and mosquito net. Curtains for all windows, Fast Clip fastening system, Mega Bag.

Type	Weight	Item no.	Price
300 Ducato	23.2 kg	071/623	1,453.00
300 Ducato H3	NEW 24 kg	071/835	1,678.00
F80 300 H	23.2 kg	071/516	1,655.00
300 XL	24.2 kg	071/615	1,667.00
300 XXL	25.8 kg	071/616	1,770.00

+ Accessories



from 511.00

Motor Kit Compact

Motor Kit 12 V DC can be retrofitted to your awning. The motor also allows you to extend the awning manually. Nominal voltage: 12 V; Weight: 2.3 kg

Motor Kit Compact F80s

polar white	071/087	511.00
titanium	071/088	511.00
black	071/089	511.00

Motor Kit Compact F80L

polar white	071/084	552.00
titanium	071/085	552.00
black	071/086	552.00

Awning Light Kit Strip Awning F80

LEDs for the front panel and housing, for maximum illumination. The kit consists of a self-adhesive LED strip (5 m). The COB LED strip guarantees a better, homogeneous light distribution. Neutral 4000 K light for better ambient lighting, also excellent for reading and relaxing. Nominal voltage: 12 V; Nominal capacity: 55 W; Luminous flux: 5115 lm; Length: 5 m; Weight: 300 g

071/747 114.00



114.00

NEW



from 1,453.00

Front Wall Extension

With the front wall extension, the Privacy Room can be easily adapted to the right awning size. Select a basic model according to your awning. Add a front wall extension to extend your awning to the length you want.

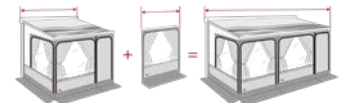

Width	For awning length	Weight	Item no.	Price
20 cm	320 cm	300 g	071/518	57.00
40 cm	340 cm	600 g	071/519	63.00
70 cm	370 cm	700 g	071/521	81.00
100 cm	400 cm	900 g	071/523	126.00
125 cm	425 cm	1.2 kg	071/524	155.00
150 cm	450 cm	1.4 kg	071/528	179.00



from 1,257.00

Awning Package Fiammastore F80s for Ducato

Corresponding awning version F80s for Ducato in the lengths 320, 370 and 400 in Deep Black. Suitable for Fiat Ducato, Citroën Jumper, Peugeot Boxer from 06/2006 and Opel Movano from 06/2021.

Scope of delivery: awning, black bracket, Kit Rain Guard Slim and Kit Cover for protection against water

Casing colour: black; **Fabric colour:** Royal Grey; **Extension:** 250 cm

Awning length	Weight	Item no.	Price
320 cm	28.5 kg	071/620	1,257.00
370 cm	31.5 kg	071/621	1,322.00
400 cm	33 kg	071/622	1,376.00

Telescopic Arm Rafter F80

The telescopic arm for attachment to the F80s/L awnings ensures greater stability and prevents the arms from closing in all weather conditions. Integrated into the awning arms, can be used as required. Easy to use, can be detached with a simple click. Suitable for F80 awnings from model 2024 onwards. The awning arms will be equipped as standard to accommodate the telescopic arm.



NEW

51.00

F80s	071/822	51.00
F80L	071/823	56.00



from 263.00



For right and left

Side Wall Side W Pro

Convenient side wall with large window and groundsheet extension. Made of water-repellent, UV-resistant and washable vinyl. Simple as-

sembly thanks to the included telescopic aluminium poles and ground spikes. Can be used on the left- and right-hand side. Incl. adapter.

	Mounting height	F40	F45	F65	CS	F35	F80/L	Weight	Item no.	Price
Side W Pro Van F45	180 – 200 cm	–	x	–	–	–	–/–	3.4 kg	071/051	263.00
Side W Pro F45, F65, F80	225 – 280 cm	–	x	x	–	–	x/–	4.2 kg	071/048	263.00
Side W Pro XXL F45, F65, F80	280 – 330 cm	–	x	x	–	–	x/–	4.5 kg	071/049	309.00
Side W Pro F65, F80 Ducato	225 – 280 cm	–	–	x	–	–	x/–	4.2 kg	071/053	263.00
Side W Pro CS, F35	240 – 260 cm	–	–	–	x	x	–/–	4.5 kg	071/054	245.00
Side W Pro F35 Van	180 – 220 cm	–	–	–	–	x	–/–	4.2 kg	071/057	256.00
Side W Pro F40	180 – 210 cm	x	–	–	–	–	–/–	3 kg	071/062	249.00
Side W Pro F80 XL	245 – 280 cm	–	–	–	–	–	x/x	4.8 kg	071/481	306.00

from 132.00



with windows

Front Wall Blocker Pro

Front walls for crank or bag awnings with a piping rail in the front cover.

Convenient front wall with large window and groundsheet extension. Made of water-repel-

lent, UV-resistant and washable vinyl. Easy to install by pulling it into the piping rail. Pegs included as standard.

Size	Length	F45	F65	CS	F35	F80	F40	Weight	Item no.	Price
100	100 cm	x	x	x	x	x	–	800 g	071/050	132.00
250	235 cm	x	–	x	x	–	–	2.7 kg	071/014	203.00
260 Van	250 cm	x	–	–	x	–	x	2.7 kg	071/015	227.00
280	255 cm	–	–	x	x	–	–	3 kg	071/016	207.00
300	285 cm	x	x	x	x	x	–	3.2 kg	071/017	230.00
325	310 cm	x	–	–	–	x	–	3.4 kg	071/466	242.00
350	335 cm	x	x	x	–	x	–	3.8 kg	071/018	242.00
375	360 cm	x	x	–	–	x	–	4.1 kg	071/019	257.00
400	385 cm	x	x	x	–	x	–	4.5 kg	071/027	261.00
425	410 cm	x	x	–	–	x	–	4.7 kg	071/028	283.00
440	415 cm	–	–	x	–	–	–	4.9 kg	071/029	283.00
450	435 cm	x	x	–	–	x	–	5 kg	071/030	283.00

from 131.00



without windows

Front Wall Blocker

Convenient front wall for protection against sunlight and rain. Easy to install by using the provided pegs. Height: 140 cm

Size	Length	F45	F65	CS	F35	F80	F40	Weight	Item no.	Price
260	253 cm	x	–	x	x	x	x	2.3 kg	071/052	131.00
300	285 cm	x	x	x	x	x	–	2.6 kg	071/033	139.00
325	310 cm	x	–	x	–	x	–	2.7 kg	071/467	154.00
350	335 cm	x	x	x	–	x	–	2.9 kg	071/035	154.00
400	385 cm	x	x	x	–	x	–	3.3 kg	071/036	157.00
450	438 cm	x	x	x	–	–	–	4 kg	071/056	179.00

NEW

from 242.00



Fits on the left and on the right!

Side Wall Side Block

The convenient side wall in combination with the blocker front wall is set up quickly, protects against sun and rain and provides more privacy. With aluminium tensioning pole and pegs as standard. Only version that fits on both the left

and the right side. Also fits awnings of other brands. There are two models available (F45/ F80s and CaravanStore XL). Height: 260 cm

Length	F45	F65	CS	F35	F80	F40	Weight	Item no.	Price
230 cm	x	–	–	–	x	–	3.3 kg	071/837	246.00
240 cm	–	–	x	–	–	–	3.5 kg	071/838	242.00



FIAMMA
home is everywhere

+ Accessories



from 42.00

Tensioning Pole Rafter

The tensioning pole keeps the awning sheet tensioned. Thus, water can drain easily. Made of solid aluminium, with wall mounting for storage inside the vehicle.

Rafter F45, F65, F80s

Suitable for extensions up to 250 cm and lengths up to 550 cm. Adjustable from 142 cm to 265 cm. Standard with the F45s from 400 cm.

Weight: 800 g **071/142** **55.00**

✓ Telescopic – takes up little space when closed

+ Accessories

Tensioning Strap Tie Down

The tensioning system **Tie Down** by Fiamma is now also available in yellow for better visibility. For awnings up to 600 cm. Essential in any wind and weather. **Scope of delivery:** 1 tensioning strap (11 m), 2 ground spikes, 1 tension spring.

black **071/191** **26.00**
yellow **071/064** **26.00**

Tie Down S: An innovative tensioning system for secure attachment to the front wall of the awnings F45, F65, F80, F35 and CaravanStore and the side walls of Privacy. **Scope of delivery:** 2 tensioning straps (3 m each), 2 ground spikes, 2 tension springs, 2 front wall hooks (for F45, F65, F80 with double piping in the front wall or CaravanStore/F35).

black **071/196** **34.00**
yellow **071/063** **34.00**

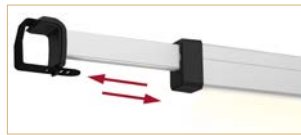

Tensioning Pole Rafter LED

The Rafter tensioning pole ensures that the awning fabric is optimally tensioned, while the integrated LED lighting creates a cosy atmosphere. It is available in several versions for different awnings and is quick and easy to install.

- New model with COB* LED strips
- Easier installation and convenient handling
- Power supply via jack and cigarette lighter (12 V socket)
- Uniform light thanks to PVC diffuserneutral light (4000 K)

Nominal voltage: 12 V

Nominal capacity: 13.5 W

Luminous flux: 1228 lm



NEW

119.00



* Chip On Board: COB LED strips are LED strips that produce homogeneous lines of light without the classic dotted effect.

F43van, F40van, F45s 260

Attached horizontally to the awning arms: higher wind resistance and no formation of water pockets in the rain.

Extendable: 135 – 235 cm.

Weight: 1.26 kg **071/739** **119.00**



from 26.00

BEST SELLER

Tie Down S CS (CaravanStore) is attached to the supporting feet of CaravanStore/F35pro.
Colour: black **071/189** **33.00**

Tips & tricks

The most common errors happen while setting up the awning. To avoid unnecessary strain of the awning bracket on the vehicle wall, only crank out the awning until the support feet can be folded out and put down. Only if this has been done, the awning can be fully extended. In case it rains, a tensioning pole – which is available from most manufacturers as an accessory – can be used. However, please keep in mind that the tensioning pole must not be installed permanently, because the awning cloth might get deformed in extreme heat. Alternatively, the awning can be lowered on one side during rain so that the water can run off freely and no water pockets can form. Never leave your awning closed for a long period of time while it is wet! In case it gets windy, you need to always secure your awnings with tensioning straps. However, even if the weather is fine, keep this in mind: whenever you leave the vehicle, use a tensioning strap and lower the support leg on one side!



Tips & tricks

In Italy and Spain, it is mandatory to mark the overhanging load clearly. The warning sign must always be affixed if the load protrudes to the rear beyond the dimensions entered in the vehicle registration document.

15.00

not for Italy and Spain



Warning Sign

Lightweight plastic material. Comes with four round rear reflectors. Non-reflective.

Not permitted in Italy and Spain!

Material: plastic; Dimensions (WxH): 50x50 cm; Weight: 195 g **137/246 15.00**

33.50

Italy



Aluminium Warning Sign for Italy

For overhanging loads. According to the Italian Highway Law, aluminium warning signs are required since 1/1/1995. They are covered with a special reflective foil and must have four holes with eyelets. Material: aluminium;

Dimensions (WxH): 50x50 cm; Weight: 765 g **137/247 33.50**

46.50

Spain



Special Load Warning Sign Spain

Each overhanging load must be marked with a red and white hatched warning sign. In contrast to the warning sign for Italy, an embossed and black painted border is mandatory. Dimensions (WxH): 50x50 cm; Weight: 1.05 kg

137/248 46.50



More Flexibility at your holiday destination.

Why not just take your bikes with you on holiday? This makes you more independent and flexible. With the bike and load carriers designed for vans and campers, you can take your bikes, e-bikes and even scooters with you wherever you go.

We offer suitable bike carriers from well-known manufacturers for most camper vans as well as for small and mini campers. In this catalogue, you will find bike carriers for the following vehicles:

Camper vans

- VW T4/T5/T6
- Citroën Spacetourer, Peugeot Traveller, Toyota ProAce Verso, Opel Zafira Life
- Ford Custom
- Mercedes Viano, Vito, V-Class
- Renault Trafic, Opel Vivaro

Mini campers

- VW Caddy

Main catalogue

Other bike carriers can be found in the main catalogue starting page 185.

Vans

- Fiat Ducato, Citroën Jumper, Peugeot Boxer
- Mercedes Sprinter, VW Crafter
- Renault Master, Opel Movano
- Ford Transit

Bike Protective Cover City

The protection cover for 3 bicycles is pulled over from the back, and also covers the bottom of the bike rack. At the back, 2 rubber tensioners are already integrated. The sewn-on transparent film bag for a warning sign is also the fixing point of the optionally available tensioning straps. Material: Polyester 210D, with high-quality PU coating at the back. **89 553 69.00**

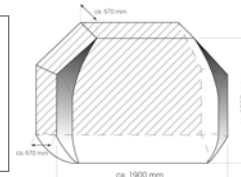

HINDERMANN





Thule WanderWay

Rear carrier for the VW T6 minivan, which can be mounted quickly and easily thanks to its special adaptation to the tailgate of the VW T6. With the Thule WanderWay, 2, by using the optionally available extension sets, up to 4 normal bicycles can be transported. Alternatively, the robust construction can also carry 2 e-bikes. The maximum load capacity is 60 kg. The Thule WanderWay has been designed with user friendliness in mind. For example, the trunk can be opened effortlessly without mounted bicycles. Once mounted, the Thule WanderWay can easily remain on the car for long periods of time, and the elevated position of the carrier leaves the taillights and license plates free.

When the bicycles stand on the easily adjustable, side-sliding rails, they are quickly and securely secured by the ratchet wheel holders and lockable Thule AcuTight bicycle racks. To ensure this safety, the carrier has been subjected to extreme load tests. Weight 12.4 kg.

Colour	Item no.	Price
black, silver	90 650	649.00
black	90 651 NEW	649.00

without illustration: Extension Set for 3rd Bike

One additional rail and one additional support arm.

aluminium	90 652	151.00
black	90 657 NEW	151.00

without illustration: Fatbike Rails, black

Particularly long, easy to install rail to take on bikes with 3 to 5 inch wide tires. Max. load capacity: 30 kg.

	90 654	112.00
--	--------	--------

Extension Set for 4th Bike

An additional split rail and an additional support arm.

aluminium	90 653	151.00
black	90 658 NEW	151.00



649.00

NEW



440.00

Bike Carrier Carry-Bike VW T4

Suitable for VW T4 (from 1991 on) with a tailgate. Also suitable for models VW California, VW Coach, VW Caravelle and VW Multivan.

VW T4, 08/1990 – 2003

Colour: silver; max. bikes: 4; Max. load: 60 kg; Dimensions (WxHxD): 128x138x54 cm; Weight: 8.3 kg

	136/567	440.00
--	---------	--------

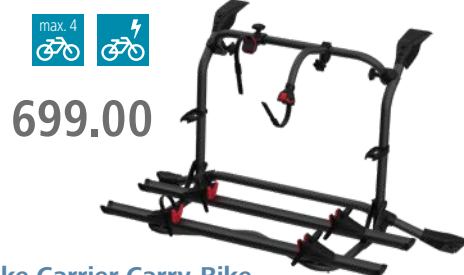

699.00

Bike Carrier Carry-Bike VW T5 Pro Deep Black

Modern design, quick attachment. Suitable for T5 from 07/2003 on with tailgate.

VW T5, 2003 – 06/2015

Colour: black; max. bikes: 4; Max. load: 60 kg; Dimensions (WxHxD): 167x88x63 cm; Weight: 13 kg

	136/254	699.00
--	---------	--------

Additional bikes

Rail Premium	136/596	89.00
3 rd bike Bike-Block Pro S 2	136/181	35.00
4 th bike Bike-Block Pro S 4	136/183	39.00



from 522.00

Bike Carrier Carry-Bike VW T5/6 D

For VW T5/T6 D with a double rear door. Easy attachment with holding plates, without drilling.

VW T6 (incl. T6.1), 07/2015 – ..., VW T5, 2003 – 06/2015

Colour: silver, black; max. bikes: 2; Max. load: 35 kg; Dimensions (WxHxD): 128x144x46.5 cm; Weight: 7.67 kg

silver	136/259	522.00
black	136/260	634.00



562.00

Bike Carrier Carry-Bike VW Caddy from 2016

For attachment to the tailgate of the VW Caddy from model year 2016. For transporting up to 4 bikes.

VW Caddy IV, 06/2015 – 02/2020

Colour: silver; max. bikes: 4; Max. load: 60 kg; Dimensions (WxHxD): 128x130x55 cm; Weight: 11.7 kg

	136/258	562.00
--	---------	--------

Additional bikes

Rail Plus	136/291	60.00
3 rd bike Bike-Block Pro S 2	136/185	30.00
4 th bike Bike-Block Pro S 4	136/187	35.00

Bike Carrier Carry-Bike VW T6 Pro Deep Black

Modern, quick and easy attachment, solid suspension at the tailgate reinforcement points. Suitable for T6 from 2015 on.

VW T6 (incl. T6.1), 07/2015 – ...

Colour: black; max. bikes: 4; Max. load: 60 kg; Dimensions (WxHxD): 167x88x63 cm; Weight: 15 kg

	136/255	722.00
--	---------	--------

Additional bikes

Rail Premium	136/596	89.00
3 rd bike Bike-Block Pro S D2	136/192	54.00
4 th bike Bike-Block Pro S D3	136/193	57.00



722.00

✓ Please pay attention to the load capacity while loading e-bikes.

FIAMMA
home is everywhere



Bike Carrier Adventure Rack



from 1,609.00



Adventure Rack Fiat Ducato

Incl. 1 crossbar and lighting strip. Loading height: approx. 67 cm.

Citroën Jumper 250/290, Fiat Ducato X250/ X290, Peugeot Boxer 250/290 2006 – ..., Opel Movano C, 2021 – ...

Scope of delivery: fastening claws, lighting strip, bike rails with bike wheel chocks
Colour: black; Max. load: 60 kg

max. bikes: 2

Dimensions (W x H x D): 182 x 152 x 76 cm
Weight: 23.5 kg **136/732 1,609.00**

max. bikes: 4

Dimensions (W x H x D): 182 x 152 x 91 cm
Weight: 28.5 kg **136/733 1,812.50**



from 692.50



Adventure Rack VW T5 / T6

Incl. 2 crossbars.

Scope of delivery: fastening claws, bike rails with bike wheel chocks

Colour: black; Max. load: 60 kg

VW T5, 2003 – 06/2015

max. bikes: 2

Dimensions (W x H x D): 140 x 124 x 54 cm
Weight: 18 kg **136/382 692.50**

max. bikes: 4

Dimensions (W x H x D): 140 x 124 x 90 cm
Weight: 23 kg **136/383 855.00**



The Adventure Rack universal carrier can be extended or redesigned to suit your needs. The solid basic carrier can, for example, be equipped with bike rails for summer holidays and the optional ski and snowboard kit can be attached for winter holidays. But with the handy Adventure Rack accessories, there are even more possibilities.



VW T6 (incl. T6.1), 07/2015 – ...

max. bikes: 2

Dimensions (W x H x D): 140 x 124 x 54 cm
Weight: 18 kg **136/384 692.50**

max. bikes: 4

Dimensions (W x H x D): 140 x 124 x 90 cm
Weight: 23 kg **136/385 855.00**

+ Accessories

✓ Two crossbars are always required to attach the accessories.

476.50



Spare Wheel Holder

Spare wheel holder suitable for a bolt circle of 118 mm to 130 mm for the EuroCarry universal carrier Adventure Rack. Material: aluminium; Dimensions (W x H x D): 75 x 38 x 20 cm; Weight: 4 kg **136/734 476.50**

201.50



Crossbar

Crossbar with fastening groove to take reserve bracket, surf kit and ski/snowboard kit for the EuroCarry universal carrier Adventure Rack. Incl. tube connector. Material: aluminium; Dimensions (W x H x D): 96 x 4 x 5 cm; Weight: 1 kg **136/737 201.50**

259.00



Ski/Snowboard Kit

Ski/snowboard kit suitable for 4 pairs of skis or 2 snowboards for the EuroCarry universal carrier Adventure Rack. Content: 2 pieces; Material: aluminium; Dimensions (W x H x D): 54 x 9 x 9 cm; Weight: 2.5 kg **136/736 259.00**

236.50



Surf Kit

Surf kit for the EuroCarry universal carrier Adventure Rack. Content: 2 pieces; Material: steel; Dimensions (W x H x D): 45 x 12 x 4 cm; Weight: 2.29 kg **136/735 236.50**

from 392.90



Luggage Box

Lockable luggage box for the EuroCarry universal carrier Adventure Rack. Material: aluminium; Dimensions (W x H x D): 105 x 33 x 24 cm; Weight: 7.8 kg **136/738 879.00**

879.00



Insert Tray

Insert tray for the EuroCarry universal carrier Adventure Rack. Material: aluminium; Dimensions (W x H x D): 105 x 60 x 8 cm; Weight: 3.33 kg
for 2 bikes **136/711 392.90**
for 4 bikes **136/712 430.60**



Roof Rail Adventure Roof

This new type of roof rail in elegant black is the ideal addition to your van. Suitable for many vehicle models. In combination with the crossbars and planks, the roof rail can be adapted to your needs.

Colour: black; Material: aluminium; Max. load: 200 kg



from 1,221.60



VW Crafter Generation 2, 11/2016 – ..., MAN TGE, 2017 – ...

Interior dimensions 3.35 x 1.55 m
Without planks, awning adapter and crossbar.
Factory-mounted rail required.

Dimensions (LxWxD): 342 x 162 x 6 cm
Weight: 14.4 kg **136/365 1,527.00**

Crossbar, 2 pieces; Length: 155 cm;
Weight: 4.5 kg **136/360 245.30**

Walkable Plank, Length: 335 cm;
Weight: 4.8 kg **136/320 133.40**

VW T6 (incl. T6.1), 07/2015 – ..., VW T5, 2003 – 06/2015

Interior dimensions 2.73 x 1.38 m
Incl. 4 crossbars, without planks.
Dimensions (LxWxD): 280 x 145 x 6 cm

Weight: 21.2 kg **136/386 1,465.90**

Crossbar, 2 pieces; Length: 127 cm;
Weight: 4 kg **136/388 245.00**

Walkable Plank, Length: 273 cm;
Weight: 3.9 kg **136/387 133.50**

Peugeot Boxer 250, Citroën Jumper 250, Fiat Ducato X250, short wheelbase 2006 – 2014, Opel Movano C, 2021 – ...

Interior dimensions 2.93 x 1.60 m
Without planks, awning adapter and crossbar.
Dimensions (LxHxD): 300 x 167 x 6 cm;
Weight: 14.3 kg **136/714 1,221.60**

Crossbar, 2 pieces; Length: 160 cm;
Weight: 4.4 kg **136/716 245.30**

Walkable Plank, Length: 293 cm;
Weight: 4.2 kg **136/753 133.50**

Peugeot Boxer 250, Citroën Jumper 250, Fiat Ducato X250, long wheelbase 2006 – 2014, Opel Movano C, 2021 – ...

Interior dimensions 3.53 x 1.60 m
Without planks, awning adapter and crossbar.
Dimensions (LxWxD): 360 x 167 x 6 cm;
Weight: 15.3 kg **136/715 1,527.00**

Crossbar, 2 pieces; Length: 160 cm;
Weight: 4.4 kg **136/716 245.30**

Walkable Plank, Length: 353 cm;
Weight: 5.1 kg **136/754 145.00**

Information

The load capacity of 200 kg is distributed over 4 crossbars.

Attention: The max. roof load must not be exceeded!



Information

To attach a Thule series 6000 awning incl. adapter, the width of the rail must be shortened (item no.: 136/714 and item no.: 136/715).

Roof Box Force XT

Versatile roof box, designed for daily use. Its aerodynamic lid material imparts a unique design as well as a high scratch-resistance to the box. The aerodynamic shape lowers the noise emission while driving. Thanks to the PowerClick system, the boxes are installed quickly. The integrated torque display indicates via a "click" sound when the box is installed properly, ensuring a quick and safe fastening. The DualSide opening system allows loading and unloading from both sides and further facilitates installation. The integrated SecureLock technology ensures the lid is closed entirely and locked securely on all edges. Moreover, the extra large locking knob is easy to grip with gloves and protects the Thule Comfort Key against damage; load capacity: 75 kg.

549.00



455.00



599.00

Type	Volume	Dimensions (L x W x H)	Weight	Item no.	Price
Force XT S	300 l	139x89.5x39 cm	14.3 kg	89 405	455.00
Force XT M	400 l	175x82x45.5 cm	16.4 kg	89 406	549.00
Force XT L	450 l	190x84x46 cm	18.7 kg	89 407	599.00





CARRY-BIKE camping vans

For attachment to camper vans. The mounting brackets are included in the scope of delivery and enable a secure attachment to the rear doors.



819.00



Bike Carrier Carry-Bike V-Class Premium

From model year 2015 onwards equipped with two rails as standard. The mounting bracket can be mounted at 2 different heights. In the low-load position, the license plate light 136/532 is required.

Scope of delivery: 1 Bike-Block Pro S 3, 1 Bike-Block Pro S 1, 1 Fixing-Bar, 1 Security Strip, 2 Rail Plus, 2 Rack Holders, mounting bracket

Colour: silver; max. bikes: 4; Max. load: 60 kg; Dimensions (WxHxD): 128x95x70 cm; Weight: 12.9 kg **136/262 819.00**

Additional bikes

Rail Plus	136/291	60.00
3 rd bike Bike-Block Pro S 2	136/185	30.00
4 th bike Bike-Block Pro S 4	136/187	35.00



532.00



Bike Carrier Carry-Bike Renault Traffic D

Suitable for Renault Traffic D and Opel Vivaro with a double tailgate.

Scope of delivery: 1 Bike-Block Pro S 3, 1 Bike-Block Pro S 1, 1 Security Strip, 2 Rail Plus, mounting bracket

Colour: silver; max. bikes: 2; Max. load: 35 kg; Dimensions (WxHxD): 128x144x51 cm; Weight: 7.3 kg **136/264 532.00**



660.00



Carry-Bike Mercedes Viano

Suitable for the Mercedes Viano with tailgate and the Mercedes Vito 2004 – 2014.

Scope of delivery: 1 Bike-Block Pro S 3, 1 Bike-Block Pro S 1, 1 Rack Holder, 1 Security Strip, 2 Rail Quick Pros, mounting bracket, number plate holder

Mercedes-Benz Viano, Vito, 2003 – 2014

Colour: silver; max. bikes: 3; Max. load: 50 kg; Dimensions (WxHxD): 128x110.5x59 cm; Weight: 10 kg **136/580 660.00**

Additional bike

Rail Quick Pro	136/510-5	57.00
3 rd bike Bike-Block Pro S 2	136/185	30.00



615.00



Bike Carrier Carry-Bike Ford Custom Nugget/Nugget Plus built since 2012

The bike carrier was adapted to the vehicle shape and adheres to the upper part of the tailgate thanks to a smoothed bracket.

Scope of delivery: 1 Bike-Block Pro S 3, 1 Bike-Block Pro S 1, 1 Security Strip, 2 Rail Plus, 2 Rack Holders, mounting bracket

Colour: black; max. bikes: 3; Max. load: 50 kg; Dimensions (WxHxD): 154x87x45 cm; Weight: 8.35 kg **136/266 615.00**

Additional bike

Rail Plus	136/292	68.00
3 rd bike Bike-Block Pro S 2	136/181	35.00

Please pay attention to the load capacity while loading e-bikes.

FIAMMA
home is everywhere



513.00



Bike Carrier Carry-Bike Opel Vivaro, Renault Trafic

Opel Vivaro, 2001 – 2019, Renault Trafic II, 2001 – ..., Fiat Talento, 2016 – ... The number plate light 136/532 is required for use (not included in delivery).

Scope of delivery: 1 Bike-Block Pro S 3, 1 Bike-Block Pro S 1, 1 Security Strip, 2 Rail Plus, 2 Rack Holders, mounting bracket

Colour: silver; max. bikes: 4; Max. load: 60 kg; Dimensions (WxHxD): 128x143x53 cm; Weight: 9.1 kg **136/263 513.00**

Additional bikes

Rail Plus	136/291	60.00
3 rd bike Bike-Block Pro S 2	136/185	30.00
4 th bike Bike-Block Pro S 4	136/187	35.00



from 601.00



Bike Carrier Carry-Bike PSA

Citroën SpaceTourer, Toyota ProAce Verso, 2016 – ..., Opel Zafira Life 2019 – ...

Scope of delivery: 1 Bike-Block Pro S 3, 1 Bike-Block Pro S 1, 1 Security Strip, 2 Rail Plus, mounting bracket

max. bikes: 4; Max. load: 60 kg; Dimensions (WxHxD): 145.8x62.5x119 cm; Weight: 11.3 kg

silver	136/267	601.00
black	136/268	663.00

Additional bikes

Rail Plus silver	136/291	60.00
3 rd bike Bike-Block Pro S D2	136/189	52.00
4 th bike Bike-Block Pro S D3	136/190	54.00

Rail Plus black	136/292	68.00
3 rd bike Bike-Block Pro S D2	136/192	54.00
4 th bike Bike-Block Pro S D3	136/193	57.00

silver



attachment
Kit Frame



structure



complete bike carrier



bike carrier
Carry-Bike Frame

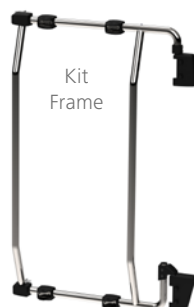

Base Carrier Carry-Bike Frame

With the new Carry-Bike Frame series, there is only one bike carrier, the Carry-Bike Frame, for all vehicle models. With the help of the matching Kit Frames, which must be ordered separately, this bike carrier can be attached to the different vehicle models.

Scope of Delivery: 1 Bike-Block Pro S 3, 1 Bike-Block Pro S 1, 1 Rack Holder, 1 Security Strip, 2 Rail Plus, mounting bracket

max. bikes: 3; Max. load: 50 kg; Dimensions (WxHxD): 128x136x60 cm; Weight: 9.37 kg

silver	136/269	463.00
black	136/270	562.00

Kit Frame Carry-Bike Frame

Fiat Ducato X250/X290, all models, 06/2006 – ...

Weight: 10.8 kg 136/271 893.00

Mercedes-Benz Sprinter W907/W910, all models, 06/2018 – ...

Weight: 9.5 kg 136/272 826.00

VW Crafter Generation 2, all models, 11/2016 – ...

Weight: 9.5 kg 136/273 826.00

3,075.00

✓ Easy to load thanks to electrical lowering!



MADE IN GERMANY



from 463.00

Euro Carry
Caravan- & Reisemobilzubehör

MADE IN GERMANY

375.00



Bike Carrier Nuevo

Versatile thanks to individual height adjustment between 80 – 155 cm. Suitable for motorhomes and in combination with the mounting rail set also for the vans Renault Master and Opel Movano model year 2000 – 2010.

Carries two bicycles, with extra wide support brackets for ideal load distribution.

For attachment to the Renault Master II or the Opel Movano A, an additional mounting rail set is required.

Max. number of bikes: 2; max. load: 40 kg

Please order mounting rail set separately!
Not suitable for 270° doors!

Scope of delivery: 2 fastening claws, 2 bike rails, 4 tyre holders with 4 lashing straps
Renault Master II, 2003 – 2010,
Opel Movano A, 1998 – 2010

Colour: silver; Dimensions (WxHxD): 125x125x73 cm; Weight: 7 kg

136/404 375.00

w/o illu. Mounting Rail Set

Length: 75 cm 136/406-5 109.00



Bike Carrier Electric for Ducato/Jumper/Boxer

The electric bike carrier by EuroCarry was designed for the Fiat Ducato, the Citroën Jumper and the Peugeot Boxer built since 2006. This bike carrier allows you to transport two e-bikes with a max. total weight of 50 kg. Thanks to the bike carrier, which can be lowered up to 110 cm electrically, tediously loading the bikes is finally a thing of the past.

The bike carrier comes partly pre-assembled. A 12 V power connection is required. It is mounted to the fastening screws of the door hinges without gluing.

To open the rear doors, the bike carrier can be laterally moved to the right when loaded. Please pay attention to the load capacity while loading e-bikes.

Scope of delivery: 2 fastening claws, 2 bike rails, 4 tyre holders with 4 ratchet straps
Fiat Ducato X250/X290, Citroën Jumper X250/X290, Peugeot Boxer 250/290, 2006 – ...

Colour: silver; max. bikes: 2; Max. load: 50 kg; Dimensions (WxHxD): 177 x 152 x 88 cm; Weight: 36 kg 136/739 3,075.00



✓ With a lighting strip, it can be used as a low loader.

from 1,015.00

Hinged Bike Carrier

Completely pre-assembled! It is mounted using the already existing holes on the door hinges, no gluing necessary. Short mounting time. To open the rear doors, the bike carrier can be moved laterally to the right when loaded. The bike carriers can be used as high loaders or in combination with a lighting strip as low loaders. Not suitable for 270° doors!

Please pay attention to the load capacity while loading e-bikes.



Scope of delivery: 2 fastening claws, 2 bike rails, 4 tyre holders with 4 ratchet straps
Colour: black; max. bikes: 2; Max. load: 60 kg; Dimensions (WxHxD): 177 x 116 x 60 cm

Mercedes-Benz Sprinter W906, 04/2006 – 2018, VW Crafter Generation 1, 2006 – 11/2016, Mercedes-Benz Sprinter W907/ W910, 06/2018 – ...
Weight: 15.7 kg 136/741 1,015.00

VW Crafter Generation 2, 11/2016 – ..., MAN TGE, 2017 – ...
Weight: 16.3 kg 136/743 1,292.50

Citroën Jumper 250/290, Fiat Ducato X250/ X290, Peugeot Boxer 250/290, 2006 – ...
Weight: 17.2 kg 136/745 1,292.50

Opel Movano B, 2010 – 04/2021, Renault Master III, 2010 – ...
incl. lighting strip
Weight: 19.1 kg 136/768 1,609.00

✓ completely pre-assembled



Scope of delivery: 4 fastening claws, 4 bike rails, 8 tyre holders with 8 ratchet straps
Colour: black; max. bikes: 4; Max. load: 60 kg; Dimensions (WxHxD): 177 x 116 x 90 cm

Mercedes-Benz Sprinter W906, 04/2006 – 2018, VW Crafter Generation 1, 2006 – 11/2016, Mercedes-Benz Sprinter W907/ W910, 06/2018 – ...
Weight: 20.7 kg 136/740 1,255.00

VW Crafter Generation 2, 11/2016 – ..., MAN TGE, 2017 – ...
Weight: 21.3 kg 136/742 1,525.00

Citroën Jumper 250/290, Fiat Ducato X250/ X290, Peugeot Boxer 250/290, 2006 – ...
Weight: 22.2 kg 136/744 1,525.00

Opel Movano B, 2010 – 04/2021, Renault Master III, 2010 – ...
incl. lighting strip
Weight: 23.4 kg 136/729 1,842.50



589.00

✓ For Fiat Ducato, Ford Transit, Mercedes Sprinter and VW Crafter

Elite Van XT

For 2 bikes, load capacity 35 kg, 19 kg maximum load per rail.

Mounted being glued onto the right rear door without drilling. The door can be opened without detaching the wheels. The increased distance of 20 cm between the rails allows for easier and faster bike fixation; moreover, the bike platform can be mounted in 3 different heights to the vehicle for additional comfort. The bike carrier straps firmly hold the bikes during transportation. Thanks to the intelligent connections, the Van XT can easily be taken off when not in use; weight: 9.5 kg.



629.00



112.00



Fatbike Rails, black

Particularly long, easy to install rail to take on bikes with 3 to 5 inch wide tires. Max. load capacity: 30 kg. 90 654 112.00



Vehicle model	Colour	Item no.	Price
Fiat Ducato, Type 250/290, 2006/07 – ...	silver	90 656	589.00
Fiat Ducato, Type 250/290, 2006/07 – ...	black	90 659	629.00
Ford Transit, 2014/05 – ...	black	90 655	629.00
Mercedes Sprinter, 2006/04 – ...	black	90 660	629.00
VW Crafter, 2006/04 – 2016	black	90 660	629.00
VW Crafter, MAN TGE 2017 – ...	black	90 661	629.00

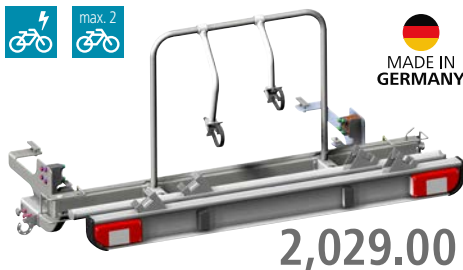

2,029.00

E -Bike Carrier

This carrier was specially developed for e-bikes and can be tilted when loaded. This gives you open access to both rear doors. When the carrier is not being used, the crossbeam can be tilted to the top to save space. The carrier is bolted directly to the chassis of the vehicle via an adapter. Installation should always be carried out by an authorised retailer (**Please note:** Not compatible with vehicles with a length of 6.2 m and 6.4 m).

Please note the load capacity when loading e-bikes.



Scope of delivery: 2 fastening claws, 2 bike rails, 4 tyre holders with 4 lashing straps

Citroën Jumper 250/290, Fiat Ducato X250/X290, Peugeot Boxer 250/290, 2006 – ...
Colour: silver; max. bikes: 2; Max. load: 80 kg;
Dimensions (LxWxH): 70x178x95 cm;
Weight: 45 kg **136/775 2,029.00**

Bike Carrier R-Bike Van

The bike carrier is suitable for two e-bikes or normal bikes and with the optional R-Bike 3Rail accessory, you can even transport three standard bikes. It is easy to install, easy to maintain and

compatible with many accessories. Designed for converted vans. Complies with the ECE R26 regulations for vehicle installation.

Vehicle model	Item no.	Price
Fiat Ducato X250/X290	136/161	529.00
Ford Transit Generation 7, 2014 – ...	136/162	635.00
Mercedes Sprinter, all models, 2020 – ...	136/163	725.00
VW Crafter Generation 2, 11/2016 – ...	136/164	719.00
Renault Master, all models, 2014 – ...	136/165	730.00

from 529.00

NEW



+ Accessories

Multi-Purpose Conversion Kit R-Bar

The accessories for the bike carrier R-Bike Van transform it into a versatile multi-purpose carrier that can transport various types of leisure equipment. Specially designed for use with R-Skirun and R-Wave accessories, this kit is easy to attach using screws. It includes two bars and the necessary fastening material.

136/166 109.00

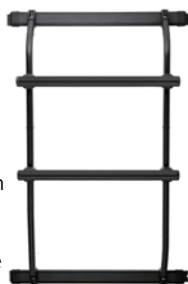

109.00

165.00



Ski Set R-Skirun for Bike Carrier R-Bike Van

This accessory for the R-Bike Van offers a safe and stress-free way to transport skis and snowboards. The door can be opened while the skis are loaded. With locking system, padlock and an ergonomic release button. Made from anodised aluminium and injection-moulded plastic. For up to four pairs of coupled skis or two pairs of skis with two snowboards.

136/167 165.00

549.00

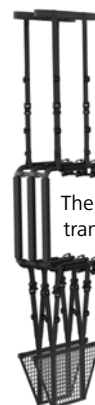

Shelving System R-Wave for Bike Carrier R-Bike Van

The modular shelving system is perfect for transporting water equipment such as surfboards and canoes. The door can be opened while the equipment is loaded. Made of tubular aluminium columns and soft foam rubber. For up to five surfboards, three surfboards and one canoe or one surfboard and two canoes.

136/168 549.00

LIPPERT

Bike Carrier Slide Move DS-250

For Fiat Ducato vans built since 2006/07 and vehicles identical in construction, available carrier system which is particularly characterised by the fact that it is ambilaterally moveable. Without removing the load, this carrier can be pushed sideways to the left or right to open doors or flaps behind it. Since only the vehicle-specific steel mounts are permanently mounted on the vehicle chassis, the carrier itself can be removed or attached quickly and easily. Very well suited for the transport of heavier e-bikes.

- Load capacity 70 kg (keep in mind the rear axle load of the vehicle)
- Dimensions W 185 x D (from bumper) approx. 70 cm
- Weight without equipment set: approx. 29 kg

Scope of delivery:

Pre-assembled carrier incl. illumination with 13-pin connector plug, vehicle-specific intakes (13 or 18 kg), mounting bracket, mounting material for 2 bicycles, ECE certificate.

For	Item no.	Price
For vehicles with rear overhang 1000 mm	87 903	1,799.00
For vehicles with rear overhang 1380 mm	87 904	1,850.00



from 1,799.00

w/o ill.: 13-Pin Wiring Kit

Is needed for Bike Carrier Slide Move DS-250 and has to be ordered separately.

For	Item no.	Price
Fiat Ducato – Van 2006/07 – 2011/01	87 757	242.00
Fiat Ducato – Van 2011/02 – ...	87 783	259.00



Thule VeloSpace XT

Thanks to its spacious and stable construction – providing a loading capacity of 60 kg with 30 kg per rail, its bike rails have extra length – the VeloSpace XT bike rack can take on different types, such as children's bicycles, fatbikes or even e-bikes. The detachable articulated arms allow for easy loading of the bicycles. Thanks to

the stable connection to the trailer coupling, installation and adjustment of the rack are accomplished easily. However, even in installed and loaded state, there is always easy access to the boot thanks to the handy detaching mechanism with foot pedal. The VeloSpace XT 3 has an extra large folding angle of 70°, what makes it es-

pecially attractive for modern vans with large tailgate. The rack as well as the articulated arms are lockable. The VeloSpace XT meets the requirements of the City Crash norm.



from 785.00



without illustration: Expansion set

Extends VeloSpace XT to 3 or 4 bikes. Maximum load capacity: 15 kg. **89 145 189.95**

	Bikes	Max. load	Weight	Item no.	Price
VeloSpace XT 2	2	60 kg	18.7 kg	89 143	785.00
VeloSpace XT 3	3	60 kg	20.6 kg	89 144	885.00

Tow Bar Carrier ProBC2+

With the bike carrier for the towbar, you can easily transport up to 4 bikes. Also suitable for bikes with oversize and Y-frames. Simple installation with quick-release system. The bikes are secured with removable and lockable strap frame holders with ratchet.

- Quick-release fastener (lockable)
- Folding mechanism with foot pedal
- Tensioning straps with ratchet
- Pre-assembled
- Sturdy aluminium rails with plastic bike holder
- Max. tyre width in the rail: up to 3.25 inches
- 13-pin plug for lighting connection
- Quick and easy installation
- Suitable for common trailer coupling types
- With adjustable licence plate holder (also suitable for Austria)
- Ready for use in 3 easy steps

**EUFAB®****NEW****669.95**

Suitable for vehicles with extremely large boot lids, e.g. for VW T5/T6, as the carrier has a greater distance to the vehicle. Can be extended to carry 3 bikes if required.

Scope of delivery: 1 Security Strip, 2 fastening claws, 2 bike rails, mounting bracket
Colour: silver, black; max. bikes: 3; Max. load: 60 kg; Dimensions (W x H x D): 79.5 x 34 x 78.5 cm; Weight: 18 kg **136/061 669.95**

Tow Bar Carrier SD260

Suitable for transporting bikes on the tow bar of vans, caravans, high-roof estate cars with double rear doors and cars. The slide rails (extension: approx. 70 cm) allow you to open doors with a width of up to 85 cm.

- Strap frame holder, specially designed for sensitive frames
- Easy and fast attachment with quick-release connection system
- Also suitable for oversized bikes and for bikes with Y frame
- Robust aluminium rails with plastic bicycle holders
- Wheelbase: max. 130 cm
- Max. tyre width in the rail: 3.25 inches
- Lighting connection: 13-pin plug
- Dim. extended (W x H x D): approx. 108 x 75 x 130 cm

**EUFAB®****799.00**

Scope of delivery: 2 fastening claws, 2 bike rails
Colour: silver; max. bikes: 2; Max. load: 60 kg; Dimensions (W x H x D): 108 x 75 x 60 cm; Weight: 20.5 kg **136/028 799.00**

Accessories

EUFAB®

without illustration: Extension Set for ProBC

NEW

Extension for bike carriers of the ProBC series. For transporting a 3rd/4th bike. With lockable and detachable strap frame holders. Max. load: 15 kg; Dimensions (L x W x H): 126 x 14 x 11 cm; Weight: 3.45 kg **136/063 131.75**

Ramp

Thanks to the folding bike ramp, you no longer need to lift your bikes onto the bike carrier. Perfect for heavy bikes such as e-bikes. Easy to attach by hooking the ramp into the rail of the bike carrier. When folded, the transport dimensions are only approx. 63 cm.

Max. load: 30 kg
Pro BC 1.5 kg **136/023 45.75**
SD 260 1.2 kg **NEW 136/064 46.00**

Tow Bar Carrier Uebler

Extra light and foldable: The Uebler i-Series is equipped with the patented Uebler iQ-lock, which allows the bike carrier to be fixed on the tow bar without any lever, without further adjustment and without tools. Due to the leverage, the carrier can be clamped to the tow bar with little effort. The carrier frame and the bike rails can be folded out in just a few simple steps. The 60° or 90° folding function of the carriers is triggered by a pedal and allows you access to the boot.

**870.00****NEW**

i21 Z

Available with enlarged folding angle (90°). Allows access to the boot on vehicles with a large tailgate. Extra-wide bike rails for tyres up to 4.5". Incl. 6 keys for the lockable spacers with toothed strap for all frame diameters.

Scope of Delivery: 2 fixing brackets with toothed strap
Colour: silver; max. bikes: 2; Max. load: 60 kg; Dimensions (W x H x D): 119 x 72 x 64 cm; Weight: 13.5 kg **136/030 870.00**



NEW

THULE
SWEDEN

1,999.00

Tow Bar Thule VeloSwing

These innovative tow bar solution is designed for transporting bicycles on a Fiat Ducato or vehicles identical in construction. With the new, entirely swivelling Thule VeloSwing tow bar, you can comfortably use the same tow bar bike carrier like with a normal car. The Thule VeloSwing can be swivelled, even when loaded with up to 4 bikes or a luggage box, easily with one hand to the side so that you have unobstructed access to the rear doors of the vehicle. Easy handling with colour indicator on the permanent safety locking, which indicates when everything is locked into place. The Thule VeloSwing is completely

certified and more than just a solution for the transportation of e-bikes. With a maximum load capacity of 150 kg, the tow bar can also be loaded with, for example, a rear luggage box or other accessories. Moreover, it can pull heavy trailer with up to 3 t. (Caution: pay attention to the towing capacity of the vehicle).

Features:

- Dimensions W 157 x H 27 x D 60 cm
- Max. towing capacity: 3 t
- Max. support load: 150 kg
- Opening range: 95°
- Additional weight for the vehicle: 49 kg

87 921 1,999.00

✓ complete access to the rear also in a loaded state



without illustration: Bumper Bar Cover for Thule VeloSwing

The pre-punched bumper bar cover ensures that the VeloSwing integrates perfectly into the look of the vehicle.

For	Item no.	Price
Vehicles without parking sensors	87 923	299.00
Vehicles with parking sensors	87 924	299.00

without illustration: Wiring Kit 13-Pin

Is required for the tow bar VeloSwing by Thule and has to be ordered separately.

For	Item no.	Price
Fiat Ducato – Van, 2006/07 – 2011/01	87 925	249.00
Fiat Ducato – Van, 2011/02 – ...	87 926	249.00

Tow Bar for Vans

Tow bar specifically designed for Fiat Ducato, Citroën Jumper and Peugeot Boxer built since 2006/07 which is available with 2 different ball heads. The tow bar with fixated ball head is powder-coated, the one with detachable ball head is galvanised. Complete, dismantled assembly unit with EC type approval. The maximum towing capacity is 3 t.

Tow ball	Item no.	Price
firm	87 785	379.00
detachable	87 777	499.00



+ Accessories Wiring Kit 13-Pin



For	Item no.	Price
Fiat Ducato – Van, 2006/07 – 2011/01	87 642	219.00
Fiat Ducato – Van, 2011/02 – ...	87 650	219.00



from 409.00

✓ Crossbars

from 429.00

✓ Longitudinal rails

Thule Roof Rack

Thanks to the innovative Smart Clamp system, this roof rack is very easy to install. Crossbars for the load can be positioned flexibly on the 2 aluminium longitudinal rails to optimally adjust it to the motorhome's roof construction. The maximum load capacity is 75 kg with 2 mounted crossbars or 150 kg when 4 carriers are used. The system is compatible to an awning Thule Omnistor 6200 mounted earlier than 2017 by means of a conversion kit (item no. 89 212). The comprehensive accessory range includes e.g. rooftop boxes and carriers for kayaks and skis (see catalogue page 209). Suitable for Fiat Ducato built since 2006/07 with H2 roof and vehicles identical in construction.

Roof Rack Longitudinal Rails, Standard

Set consists of 2 rails, is required when you do not want to install an awning at the same time; can be expanded later on with the awning retrofit kit (item no. 89 215 or 216).

Type	Length	Item no.	Price
L2H2	2.85 m	89 203	469.00
L3H2	3.46 m	89 204	539.00
L4H2	3.8 m	89 205	549.00

Thule ProBar Fixpoint Evo Crossbars

To install onto the Ford Transit and VW California. Set consists of 2 rail with a length of 1.5 m each. For more need in height, an elevation kit can be mounted below for additional 3 cm.

Vehicle type	Item no.	Price
VW California	89 223	414.00
Ford Transit H3	89 227	414.00
Elevation Kit 3 cm	89 229	24.00

Roof Rack Longitudinal Rails with Awning Set

Instead of the Smart Clamps for the passengers side, this set includes a kit for simultaneous mounting of a roof awning Thule Omnistor 6200/ 6300 with Ducato package (see catalogue page 160).

Type	Length	Awning length	Item no.	Price
L2H2	2.85 m	3.25 m	89 207	429.00
L3H2	3.46 m	3.75 m	89 208	469.00
L4H2	3.8 m	4 m	89 209	479.00

without illustration: Roof Rack Awning Retrofitting Kit

To retrofit a roof awning Thule Omnistor 6200/ 6300 (see catalogue page 138) to an already existing Roof Rack System Standard (e.g. Adria Van Supreme). The kit includes a special adapter set, connectors and two sealing tapes made of EPDM (length 2 m).

Type	Awning length	Item no.	Price
L2H2	3.25 m	89 215	154.00
L3H2 / L4H2	3.75 / 4 m	89 216	164.00

Roof Rack Conversion Kit

For retrofitting the roof rack system with awning pack to the already existing roof awning Thule Omnistor 6200 / 6300 (year of construction of the adapter built before 2017).



89 212 64.00

Roof Rack Crossbars

For installation onto the roof rack longitudinal rails. Set consists of 2 rails with a length of 1.5 m each. To bridge potentially present skylights and roof constructions, 2 different heights are available. Load capacity 75 kg.



NEW

Height	Item no.	Price
15 cm	89 221	409.00
19 cm	89 222	409.00



899.95

Hullavator Pro

Kayak holder to mount on the Roof Rack system (requires longitudinal and high cross bars), made of aluminium and double coated steel. Due to its lift assistance it enables a very comfortable handling to kayaks by only one person. Double foldable, plastic coated arms lower the loading height for up to 1 m, thus kayaks can be loaded and unloaded very comfortably. Thereby gas pressure springs reduce the weight of the kayak up to 18 kg when lifting or lowering. It offers room for 1 kayak with a maximum width of 80 cm and a maximum weight of 35 kg. Two Hullavator Pro can be installed onto one vehicle.

89 231 899.95



✓ Kayak

✓ Canoe

Information

Thule products have stood for many years for:

- Innovation
- Highest quality
- Warranty against defects in material and workmanship



151.00

Portage

Canoe holder that is easy to load and suitable both for the Thule Roof Rack system and for most of the standard roof carriers. Its robust holders with round-shaped sides and weather-proof padding protect the canoe while driving. Strong tension straps are equipped with a buckle protection to avoid scratches on canoe and vehicle. Suitable for 1 canoe, max. additional load 45 kg.

89 235 151.00



💡 Tips & tricks

A roof rail provides additional storage options for camping and recreational equipment in your van. It is a perfect base for roof boxes, surfboards or solar panels.

SnowPack

Lockable roof rack made of anodised aluminium for transport of all kinds of skis and snowboards. Suitable for installation on the Thule Roof Rack System and for most standard carriers. The support surfaces (width 25 or 50 cm) of the carrier are equipped with extremely soft rubber pads, which give best grip without causing scratches on the skis or boards. The vertical spring system allows the transport of even thicker boards. 2 sets of support feet are included in delivery to carry also skis with bigger ski bindings. A very big push button allows to open and close the rack even with gloves on.

✔ Perfect for your equipment



from 202.00



Type	For	Max. load	Weight	Item no.	Price
7322	2 pairs of skis or 1 snowboard	14 kg	2.8 kg	89 246	202.00
7324	4 pairs of skis or 2 snowboards	28 kg	3.8 kg	89 247	222.00

📖 Main catalogue

Other rails, roof boxes and ladders can be found in the main catalogue on pages 204 – 209!

Canyon XT

With its stable but still elegant, light-weight steel construction and its low profile this roof frame is perfectly suitable for transport of equipment of any kind and size. Its shifted side walls facilitate loading and unloading, and well designed fairing enhance its aerodynamics. It is suitable for the Thule Roof Rack System and lockable with the Thule One-Key System. Load capacity 68 kg, loading area L 101 x W 91 x H 10 cm, dimensions L 127 x W 104 x H 15 cm, weight 13 kg. **89 253 505.00**

505.00



✔ The right roof rail for your Fiat Ducato, Citroën Jumper or Peugeot Boxer.

from 787.00

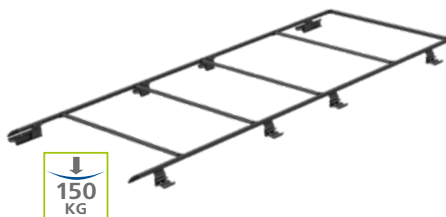

Roof Rail Ducato

Luggage carrier system for Fiat Ducato from 2006 on. Either for long or short wheelbase (can be shortened). For vehicle lengths up to 6 m. Dimensions (WxHxD): 355 x 16.5 x 141 cm; Weight: 12 kg

black 052/130 957.00
silver 052/135 787.00

927.00

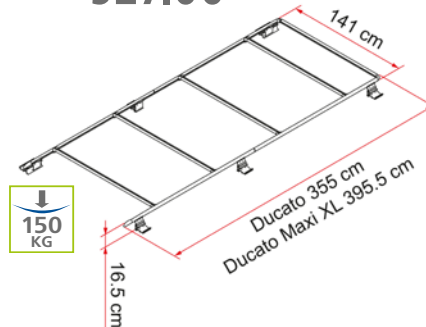

Roof Rail Ducato Maxi XL

For models built since 06/2006. For vehicle lengths up to 6.36 m. Dimensions (WxHxD): 395.5 x 16.5 x 141 cm; Weight: 13.5 kg

052/136 927.00

962.00

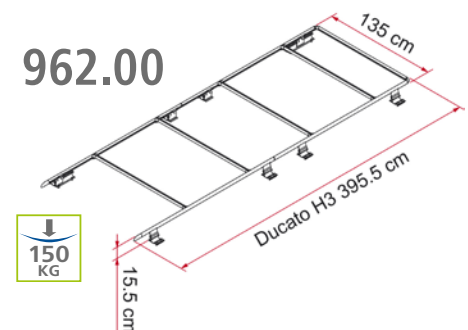

Roof Rail Ducato H3

Available for Ducato H3 (in connection with Ladder Deluxe DJ Ducato H3). For vehicle lengths up to 6.36 m. It is mounted on the original points. Incl. 4 Fixing Bar Rails as standard. The awning is attached on the right-hand side (in driving direction) with the supplied adapters. **Kit Roof Rail Ducato Extra** is available for additional load support. Dimensions (WxHxD): 395.5 x 17.5 x 135 cm; Weight: 14.2 kg **052/131 962.00**



175.00



Roller Roof Rail

Roller for easy loading. Simplifies loading a canoe, kayak or other items onto the vehicle from the rear. Easy to combine with Roof Rail Ducato, Roof Rail Ducato Maxi XL and all commercially available roof racks, except those with round profiles. Not suitable for vehicles with reversing camera. Dimensions (WxHxD): 109 x 6 x 7 cm; Weight: 1.5 kg **052/140 175.00**

139.00

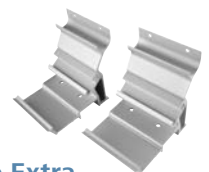

Kit Roof Rail Ducato Extra

The **Kit Roof Rail Ducato Extra** brackets are available for load-bearing support.

Content: 2 pieces; Dimensions (WxHxD): 24.5 x 16.5 x 11 cm; Weight: 1 kg

052/138 139.00

**Roof Rail STYLE**

Give your vehicle a sporty appearance with the aerodynamic shape of the roof rail Style.

- Simple installation
- Aerodynamic shape
- No drilling required on the roof

The rail is attached to the existing standard mounting points of the vehicle roof. The end pieces are glued to the roof with Sikaflex (not included). Any number of EuroCarry crossbars can be attached. It is possible to mount a Fiamma F45 awning or Omnistor Series 5 (steep face awning) and Fiamma F45.

Distributed load: 200 kg distributed on 4 crossbars.

Features: High-quality anodised aluminium construction, silver, powder-coated. The roof rail can be painted in the vehicle colour.

vehicle length 5416 mm

Dimensions (W x H x D): 145 x 12 x 334.5 cm;
Weight: 17 kg **052/153 1,325.00**

from 1,325.00



Installation option of a Omnistor awning series 5 with adapter

Vehicle model: Fiat Ducato X250/X290, Citroën Jumper X250/X290, Peugeot Boxer 250/290;
Material: aluminium; Max. load: 200 kg

vehicle length 6363 mm

Dimensions (W x H x D): 145 x 12 x 429.5 cm;
Weight: 22 kg **052/154 1,409.90**

**Awning Adapter**

Adapter set to mount the awning series 5 (roll out awning).

Content: 4 pieces;
Material: aluminium;
Dimensions (W x H x D): 9.6 x 7.2 x 5.7 cm; Weight: 700 g



114.90

052/156 114.90

Extension for Roof Rail STYLE

Two galvanised steel parts, approx. 60 mm higher.
Content: 2 pieces; Material: steel; Dimensions (W x H x D): 7.5 x 7 x 11 cm; Weight: 2.5 kg;

052/157 64.50

+ Accessories**Crossbar for Roof Rail STYLE**

Content: 2 pieces; Material: aluminium; Length: 145.8 cm; Weight: 2.8 kg **052/155 189.00**

Roof Rail 67011 from 2006 on

Only for high roof H2

Simple assembly. No drilling at the roof. The rail is attached to the existing standard mounting points of the vehicle roof. The support legs of the roof rail on the right in driving direction are also mounting points for an Omnistor series 6 awning.

Features: aluminium rack, anodised, 2 x 3 support legs, 3 cover caps in black and 4 crossbars.

Installation option for Omnistor series 6 awnings. No additional adapters necessary!

Not compatible with Fiamma awnings!

Vehicle model: Fiat Ducato X250/X290, Citroën Jumper X250/X290, Peugeot Boxer 250/290 2006/06 - ...;

Material: aluminium; Max. load: 200 kg; Dimensions (W x H x D): 143.5 x 12 x 370 cm; Weight: 16 kg **052/151 987.50**



987.50



✓ easy to attach – no drilling

+ Accessories

267.50

**Walkable Plank Made of Aluminium**

The sturdy walkable plank is mounted onto the EuroCarry rail (crossbar).

Features: anti-slip aluminium channelled sheet, 8 slot nuts M6, 8 screws M6 x 10
Material: aluminium; Max. load: 100 kg;
Dimensions (W x H x D): 25 x 1.8 x 250 cm; Weight: 2.7 kg **052/149 267.50**



43.00

Extension for Rail 67011

The extension of the EuroCarry rail allows you to attach the rail 67011 to Fiat Ducato, Citroën Jumper and Peugeot Boxer from model year 06/2006 on with a vehicle length of 636 cm.

Material: aluminium; Dimensions (W x H x D): 2.2 x 4 x 37 cm; Weight: 610 g **052/147 43.00**



EC Rear Ladder 67003

Climb the ladders of success with EuroCarry ladders! Their aluminium material makes them light but stable – absolute "must-haves" especially on the road. The anodised surface guarantees a long service life and looks good. You can combine ladders and bike carriers and add a rail system.

- Anti-slip steps
- Number plate gap
- Can be combined
- 2-years warranty
- Made in Germany

EuroCarry Ladder 67003 for Fiat Ducato, Citroën Jumper and Peugeot Boxer built since 2006

Ladder with 7 steps, completely pre-assembled, pre-shaped number plate gap, attached to the left rear door. Clear span of steps: 22 cm.

Features: aluminium ladder, anodised, 7 steps, 2 fixing rails

Max. load: 100 kg; Dimensions (W x H x D): 83 x 210 x 20 cm; Weight: 7 kg

136/406-3 509.00



509.00

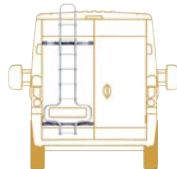

with magnetic attachment



389.00

Van Ladder

This 9-step telescopic ladder provides easy and secure access to the vehicle roof, carrier systems and superstructures. Thanks to the included magnetic attachment set (item no. 71 993, page 665), the ladder can be used and secured on all sides of the vehicle and steadily stands on any ground. It can be pulled out from 75 cm to 264 cm. It is equipped with an air pressure system which works as a pinch protection as well as serves for a secure retraction. Included in delivery is a handy carry bag. Holds up to 150 kg, dimensions W 49 x H 75/264 x D 7 cm, weight 8.1 kg.

89 394 389.00



home is everywhere



466.00

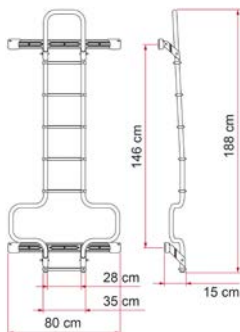

Rear Ladder Deluxe DJ Ducato

Ladder made of anodised aluminium complete with fixing bar profile for secure fastening on the left side of the rear door. Can be combined with Carry-Bike 200 DJ.

Steps: 6; Material: aluminium; Dimensions (W x H): 80 x 188 cm; Weight: 6.5 kg

052/120 466.00



478.00

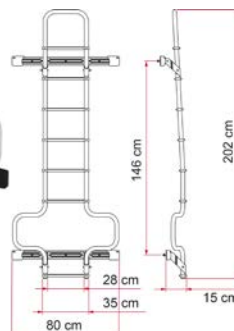

Rear Ladder Deluxe DJ Ducato H3

Deluxe DJ H3 available for the Ducato H3 from 06/2006 (in combination with Roof Rail Ducato H3).

Steps: 7; Material: aluminium; Dimensions (W x H): 80 x 202 cm; Weight: 6.9 kg

052/121 478.00

374.00



Ladder Deluxe DJ Deep Black

The robust and lightweight aluminium ladder can be folded down and is attached to the left rear door. The support tubes have a diameter of 30 mm and a thickness of 2 mm.

Steps: 8; Dimensions (W x H): 70 x 272 cm; Weight: 5.53 kg

136/295 374.00

Kit Bars Deluxe are required for attachment!

246.00



Kit Bars Deluxe

Required for attaching the Deluxe DJ Deep Black ladder to the respective vehicle model.

Mercedes-Benz Sprinter W906, 04/2006 – 2018, VW Crafter Generation 1, 2006 – 11/2016, Mercedes-Benz Sprinter W907/W910, 06/2018 – ...

Weight: 2.17 kg **136/296 246.00**

VW Crafter Generation 2, 11/2016 – ...

Weight: 2.09 kg **136/297 246.00**

Ford Transit Generation 7, 2014 – ...

Weight: 1.97 kg **136/298 246.00**



Hinged Window S7P

with aluminium frame

Infinitely adjustable hinged window for vehicles with a rounded design. Additional side windows in the rear are great for letting in natural light and creating a pleasant atmosphere, which is especially helpful when converting a van into a recreational vehicle. The elegantly designed window performs this task with flying colours while providing effective insulation and security.

- Light aluminium frame
- Elegant design with a perfectly coordinated blackout system
- Outer surface with a curvature radius of 5000 mm
- Flush-fitting pane and multi-point locking system
- Excellent thermal insulation
- Double, dark-tinted acrylic glazing
- For wall thicknesses from 22 to 43 mm
- With stepless window openers



from 449.00

DOMETIC
OUTDOOR



MADE IN GERMANY

Window for vans with curved exterior

	Cut-out	Dimensions (W x H)	Weight	Item no.	Price
280 x 380 mm	233 x 352 mm	308x408 mm	2.9 kg	207/020	449.00
490 x 500 mm	443 x 472 mm	518x528 mm	4 kg	207/021	485.00
560 x 465 mm	513 x 437 mm	588x493 mm	4.5 kg	207/022	485.00
700 x 510 mm	653 x 482 mm	728x538 mm	4.8 kg	207/023	535.00
750 x 465 mm	703 x 437 mm	778x493 mm	4.8 kg	207/024	535.00
818 x 315 mm	771 x 287 mm	843x343 mm	4.6 kg	207/025	535.00
960 x 450 mm	913 x 422 mm	988x478 mm	5.6 kg	207/026	545.00
985 x 465 mm	938 x 437 mm	1013x493 mm	6.1 kg	207/027	575.00

roofSTAR

The ultra-light roofSTAR skylights have been specially developed to meet the highest demands. They combine a completely new, innovative design with reduced weight. The extremely flat design also significantly improves aerodynamics, wind resistance and noise development while driving.

Extremely flat: The external height has been reduced by 50 % to just 72 mm.

Unique: With the roofSTAR 4, a motorised version is available for the 400 x 400 mm version for the first time.

Clever: On both models, the motorised version is operated via a switch that is integrated directly into the frame and is therefore very easy to reach.

Lighting: For the roofSTAR 4, there is optional high-quality LED lighting.

Particularly robust: The roofSTAR 4 is made of proven, UV-resistant ASA and PMMA material.

Thought through: An additional, permanently acting fly screen is integrated in the motorised version!

Effective blackout: Integrated roller blind system that effectively keeps out the light and is easy to use.

Easy to install: Generously dimensioned sealing channel to accommodate the sealant and thus prevent water from entering. Incl. 8 fastening hooks for installation with a roof thickness of 25 – 32 mm.

Flexible: The roofSTAR 4 can be easily retrofitted.

Perfect for everyday life: The inner frame of the roofSTAR skylights can be easily removed and reattached for quick cleaning.

Water management: With effective water drainage system to prevent gushing water from entering the vehicle.

Spoiler effect: The rubber sealing lip on the side of the hinge effectively minimises noise.

BRUNER
OUTDOOR IN MOTION

from 169.90



400 x 400 mm

Skylight roofSTAR 4

Cut-out nominal dimension: 400 x 400 mm
Roof thickness: 25 – 32 mm
Height above roof: 72 mm

Bracket

Weight 3.7 kg
With forced ventilation **206/334 169.90**
W/o forced ventilation **206/335 174.90**

Skylight roofSTAR 4 with LED

Bracket

Weight 3.7 kg
With forced ventilation **206/336 199.90**
W/o forced ventilation **206/337 204.90**

Electrical opening

Weight 3.7 kg
With forced ventilation **206/338 356.90**
W/o forced ventilation **206/339 362.90**

Information

The standard versions of all roofSTAR skylights are designed for a roof thickness of 25 – 32 mm. For roof thicknesses of 33 – 45 mm, an additional mounting kit is required for both roofSTAR 4 and roofSTAR 7.

Accessories

Mounting Kit 33 – 45 mm for roofSTAR

For Type roofSTAR 4 **206/352 29.90**

The MPK VisionStar series

Advantages at a glance:

- Stepless opening with rotary handle
- Low driving noise due to flat cover
- Robust double glazing made of polycarbonate

- High UV protection thanks to smoked glass cover
- Fly screen and pleated blackout blind, can be operated individually
- Available with LED lighting

■ 400 x 400 mm



from 157.50

Skylight VisionStar M

- Infinitely adjustable up to 50°
- Continuous ventilation up to 150 cm²
- Cut-out: 400 x 400 mm
- Roof thickness: 25 – 60 mm
- Height above roof: 80 mm
- Cover size: 490 x 470 mm
- Dimensions (W x H x D): 565 x 80 x 530 mm
- Weight: 3.7 kg

Roof thickness: 25 – 60 mm

cream white	206/168	157.50
signal white	206/354	157.50

Roof thickness: 55 – 90 mm

cream white	206/361 NEW	166.00
signal white	206/363 NEW	166.00

Skylight VisionStar M LED

Technical data LED illuminants:

- Light colour warm white (3000 K)
- Nomin. useful luminous flux: 2 x 490 lm
- Mains voltage: 12 V DC
- Consumption: 2 x 4 kW/h
- Nominal service life: 50,000 h
- Dimensions (W x H x D): 565 x 80 x 570 mm
- Weight: 4 kg

Roof thickness: 25 – 60 mm

cream white	206/169	235.00
signal white	206/355	235.00

Roof thickness: 55 – 90 mm

cream white	206/362 NEW	248.00
signal white	206/364 NEW	248.00

Roof Double Ventilation Titan TTC-SC21/V3

This quietly running 12 V double ventilator can be easily integrated into existing roof windows from 38 to 55 cm, such as Dometic Mini Heki or MPK, thanks to the mounting material included in delivery and the extendable mounting rails. Advantage: The roof window can be opened and closed without removing the fan. The two ventilators (ø 14 cm) with their strong reversible air flow (aeration and ventilation) ensure fast heat dissipation and regulated circulation. The air flow can be regulated in 6 different speeds via the remote control. Dimensions L 32 x W 15.6 x H 3.4 cm, weight 1.2 kg. **89 313 135.00**

from 399.00

■ 700 x 500 mm



✓ Simple. Good. Proven.

Skylight VisionStar L

- Infinitely adjustable up to 55°
- Continuous ventilation up to 150 cm²
- Cut-out: 700 x 500 mm
- Roof thickness: 25 – 60 mm
- Height above roof: 105 mm
- Cover size: 815 x 583 mm
- Dimensions (W x H x D): 872 x 105 x 610 mm
- Weight: 8.2 kg

cream white	206/155	399.00
signal white	206/356	399.00

Skylight VisionStar L LED

Technical data LED illuminants:

- Light colour warm white (3000 K)
- Nominal useful luminous flux: 2 x 590 lm
- Mains voltage: 12 V DC
- Consumption: 2 x 6 kW/h
- Nominal service life: 50,000 h
- Dimensions (W x H x D): 872 x 105 x 650 mm
- Weight: 8.49 kg

cream white	206/145	549.90
signal white	206/357	549.90

Accessories

without illustration: Adapter Frame

Adapter frame made of polypropylene for Fiat Ducato and models of identical construction. For MPK models VisionStar/VisionVent/models 29, 42, 46.

280 x 280 mm universal	206/215	23.95
400 x 400 mm universal	206/216	29.95
700 x 500 mm front	206/213	53.95
700 x 500 mm rear	206/214	57.50



■ 280 x 280 mm

mpk



from 99.95



VisionVent S pro

Smoked glass skylight with telescopic extension arms, can be put up on 4 sides. High UV protection thanks to tinted skylight material, permanent ventilation between skylights for reduced condensation.

- Modern inner frame
- Cut-out: 280 x 280 mm
- Roof thickness: 24 – 46 mm
- Height above roof: 80 mm
- Cover size: 380 x 395 mm
- Weight: 1.6 kg

With fly screen

cream white	206/223	99.95
signal white	206/365 NEW	99.95

With fly screen and blackout blind

cream white	206/217	105.95
signal white	206/366 NEW	105.95

Information

Skylights that deliver what they promise: installation, use, durability – easy, reliable, good. For caravans, motorhomes and anything that travels a lot.

without illustration: Faux-Leather Skylight Cover

Made of supple soft faux leather, a silk-grey cover for skylights. It protects the sensitive artificial glass against scratches, dirt and resin. All covers feature an all-round rubber band, which is pulled under the edge for secure hold. To fit 3-aerodynamic skylights, the cover comes with a three-dimensional design.

Suitable for	Item no.	Price
Mini Heki Style	85 309	47.50
REMItop Vario		
40 x 40 cm	85 306	27.50

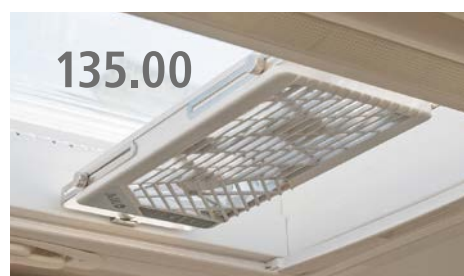

Skylight Mini Heki Style



Main catalogue
Other skylights can be found in the main catalogue or in our webshop.

The Mini Heki Style skylights provide plenty of daylight and fresh air. The windows are equipped with acrylic double glazing and can be opened in three different positions by using the convenient hand lever. A roller blind and a fly screen are included.

- Inner frame with blackout blind and fly screen
- Convenient operation of the glass dome with bracket system
- Dome with double acrylic coating
- With forced ventilation
- Catch positions: 3
- Max. opening angle: 50°
- Blackout: single-pleated
- Fly screen: single-pleated
- Frame colour: RAL 9001

■ 400 x 400 mm

from 165.00



NEW

Roof thickness: 25 – 42 mm		
With forced ventilation	206/380	165.00
W/o forced ventilation	206/382	175.00

Roof thickness: 43 – 60 mm		
With forced ventilation	206/381	165.00
W/o forced ventilation	206/383	175.00

Cut-out: 400 x 400 mm
Weight: 3.3 kg

Skylight Midi Heki Style

Let fresh air and light into your vehicle! This upgraded version of the Midi Heki Style skylight is characterised by improved safety devices, improved aerodynamics, a better look and less necessary maintenance. Proven benefits such as the blackout panel, the fly screen or the fact that it is easy to clean ensure a high level of comfort and convenience when travelling.

- Optimised aerodynamics – noise level is up to 20 % (3 dB) lower
- Thanks to the new shape, less dirt gets stuck between the roof and the dome.
- Hinge and lock are integrated into the frame and provide more safety and mechanical stability.
- Separately adjustable blackout blind and fly screen
- Well insulated dome with double acrylic glazing
- Bracket version: 3 catch positions, max. opening angle 45°
- Crank handle version: infinitely adjustable, max. opening angle 60°
- Roof thickness: 30 – 34 mm; 25 – 29 mm and 35 – 60 mm also possible
- Frame colour: RAL 9001 (pure white) or RAL 7016 (grey)
- Cut-out: 700 x 500 mm
- Weight: 8.1 kg



Retrofit Kit Lock Midi Heki Bracket

Lock for fixing the glass dome. The locking mechanism can be retrofitted to all older Midi Hekis Bracket as they cannot be fixated while being open.

206/270 41.50

Midi Heki Style Bracket

With forced ventilation		
cream white	206/386	615.00
grey	206/390	615.00

Midi Heki Style Bracket

W/o forced ventilation		
cream white	206/387	639.00
grey	206/391	639.00



■ 700 x 500 mm



grey

from 615.00

NEW



cream white

Midi Heki Style Crank

With forced ventilation		
cream white	206/388	819.00
grey	206/392	819.00

Midi Heki Style Crank

W/o forced ventilation		
cream white	206/389	829.00
grey	206/393	829.00

without illustration:

Adapter Frame Midi Heki Back

Adapter frame in size 700 x 500 mm for Midi Heki skylight (back). Can be used variably as long as it does not extend into the front area as there is no beading.

Dimensions (L x W x H): 78 x 71.5 x 12 cm
Weight: 1.95 kg **206/331 129.00**

Adapter Frame Midi Heki Front

Adapter frame for Midi Heki 700 x 500 mm skylight (front). Only for fixed use.

Dimensions (L x W x H): 78 x 71.5 x 12 cm
Weight: 1.7 kg **206/332 97.00**



129.00

Adapter Frame for Fiat Ducato 250/290

Adapter frame for Fiat Ducato type 250 and 290 with trapeze tin roof. Suitable for 400 x 400 mm skylights. Perfect for Mini Heki skylights and air conditioners.

Dimensions (L x W x H): 49 x 49 x 1 cm
Weight: 1 kg **206/027 129.00**

65.00



Adapter Frame Micro Heki

Adapter frame for compensating the edges of the Fiat Ducato.

Adapter frame for installing 280 x 280 mm Micro Heki skylights.
Weight: 330 g **206/330 65.00**



Thule Skylight

The exterior frame is made of dimensionally stable, weather-proof ASA plastic. Thus secure bonding and sealing during installation is possible. The operating knob is located on the side, keeping the opening clear across the entire surface. When closed, the Thule roof hood provides a continuous forced ventilation of 100 cm².

Both, the housing as well as the vent, have been newly composed, special attention was paid to low energy consumption (0.15 – 2.5 A) and silent operation even at high velocities. Due to the aerodynamical form no additional spoiler is needed. Due to the embedded hinge with continuous rail and the long protruding exterior capsule, rain-water can drain optimally. Furthermore the mosquito blind (standard for all models without vent) as well as the blackout blind (standard for all models) have been newly designed. The blackout blind can be opened in 3 positions. The

ventilation version provides 6 levels of aeration and deaeration, a power save function as well as a comfort mode. Circulation of air amounts to max. 20 m³ per minute. The ventilation kit can be retrofitted to all existing Thule roof hoods. Due to the perfect screw-clamping-system, the roof hood can be installed without additional drilling holes into the bodyshell, this provides the best protection against water ingress.

Technical data:

Installation dimensions 40 x 40 cm, interior frame 45.8 x 46.2 cm, exterior dimensions 45.9 x 47.2 cm. The closed roof hood is 7.8 cm in height. Thule roof hoods are suitable for roof thickness of 25 – 60 mm (from 40 mm roof thickness, the kit, item no. 89 342 is required). Materials: exterior frame made of ASA, interior frame made of polystyrene, blind frame made of ABS, hood made of polypropylene.



from 124.00

	Item no.	Price
Skylight white	89 331	124.00
Skylight transparent	89 333	124.00
Skylight white with ventilator, 12 V	89 337	314.00
Skylight transparent with ventilator, 12 V	89 339	314.00

DOMETIC

OUTDOOR



from 359.00

Fan Tastic Vent 7350

Technically identical data with model 3350, the huge advantage can be found in its comfortable handling: a remote (including handy wall mounting) is included in the scope of delivery with which the ventilation can be regulated and the opening height of the roof hood can be adjusted, additionally, the rotational speed can be adjusted infinitely.

87 178 555.00

Roof Ventilator Fan Tastic Vent

With 3-stage high-performance motor and removable mosquito screen. Clear fan blades maximise incidence of light. Exterior proportions 47.1 x 47.1 cm, suitable for skylights of 40 x 40 cm and roof thickness of 27 – 65 mm. Bodywork 12.5 cm, weight 5 kg. Material: corpus made of ABS, hood of polycarbonate/ Makrolon.

Performance:

- Stage 1: 13.5 m³/min, power consumption 23 W
- Stage 2: 18.5 m³/min, power consumption 28 W
- Stage 3: 26.5 m³/min, power consumption 36 W

Fan Tastic Vent 2250

With thermostat control, ventilator turns on or off if the preset temperature is reached.

87 171 359.00

Fan Tastic Vent 3350

Additionally with rain sensor, which ensures that the hood closes automatically if rain starts falling during ventilation.

87 175 489.00

Skylight Vent 28 F

Small skylight, suitable for spatial conditions with smaller dimensions, ensures optimum ventilation of the interior. Can be motorised with the Kit Turbo-Vent 28 F.

- Inconspicuous and elegant frame design
- In the glass colours white and crystal
- Standard mosquito net made of aluminium
- Aerodynamic
- Quick installation without additional drilling on the vehicle
- Opening with hand wheel
- With forced ventilation
- Cut-out: 280 x 280 mm
- Roof thickness: 28 – 50 mm
- Height above roof: 90 mm
- Cover size: 320 x 340 mm
- Weight: 1.8 kg

white 206/420 98.00
crystal 206/421 114.00

Kit Frame 28 Ducato 206/434 19.00



from 98.00

without illustration: Kit Turbo Vent 28 F

The Turbo Vent kit allows you to convert your skylight Vent 28 F into a motorised ventilator.

Max. air conveyance: 9 m³/min.
Nominal voltage: 12 V; Nominal capacity: 25 W;
Dimensions (ø): 180 mm; Weight: 500 g

206/422 106.00



Main catalogue

Other skylights and accessories can be found in the main catalogue from page 232.



409.00

Roof Ventilator MaxxFan Deluxe

Can be used either for deaeration and ventilation with opened roof hood or as fan with hood closed. The 10-step fan manages up to 26 m³ air exchange per minute at a power consumption of 0.2 – 2.3 amperes. The patented shock-proof and UV-resistant outer hood protects against rain when the hood is open – even while driving. The built-in electronic thermostat allows to set the desired temperature inside the camper. MaxxFan Deluxe is equipped with 2 opening levers, a mosquito net, a remote control, an electric control panel at the device and manual operation of the outer hood, in case of power failure.

Technical data:

Energy consumption 0.2 – 0.3 A, installation dimensions 40 x 40 cm, inner frame 46 x 46 cm, overall dimensions L 58.5 x W 41.7 x H 12.7 / 23.7 (opened), weight 6 kg; suitable for roof thicknesses from 25 – 80 mm.

Hood transparent 89 323 409.00
Hood white 89 324 409.00
Hood smoky grey 89 325 409.00



Pleated Fly Screen Door

The lightweight fly screen door offers campers the opportunity to enjoy a wide view of nature without having to worry about mosquitos and other pests inside the vehicle. The curved cassette and the pull-bar ensure that the door does not take up much space inside your van. Despite its size, the fly screen works quietly and smoothly.

- Easy installation with pre-assembled kit and clips
- All aluminium parts are light and durable
- Rolled edge of upper profile prevents head injuries



Sliding Door

H1 – normal roof

Citroën Jumper 250/290, Fiat Ducato X250/X290, Peugeot Boxer 250/290

Dimensions(WxH): 118.5x144.6 cm; Weight: 2.6 kg
052/170 483.90

H2, H3

Citroën Jumper 250/290, Fiat Ducato X250/X290, Peugeot Boxer 250/290

Dimensions(WxH): 118.5x173.1 cm; Weight: 3 kg
052/171 501.90

VW T5, 2009 – 06/2015, VW T6 (incl. T6.1), 07/2015 – ...

Dimensions(WxH): 98.8x134.3 cm; Weight: 2.8 kg
052/173 617.90

Mercedes-Benz Sprinter W906, 04/2006 – 2018, VW Crafter Generation 1, 2006 – 11/2016

Dimensions(WxH): 123.4x195.9 cm; Weight: 3 kg
052/172 527.90

Mercedes-Benz Sprinter W907/W910, 06/2018 – ...

Dimensions(WxH): 123.4x195.9 cm; Weight: 3 kg
052/174 527.90

VW Crafter Generation 2, 11/2016 – ..., MAN TGE, 2017 – ...

Dimensions(WxH): 126.7x188.4 cm; Weight: 3.5 kg
052/176 527.90

Tailgate

H2 – high roof

Citroën Jumper 250/290, Fiat Ducato X250/X290, Peugeot Boxer 250/290

Dimensions(WxH): 150x176.6 cm; Weight: 3 kg
052/175 527.90



Fly Screen Curtain Fiat Ducato

To ensure that annoying flies and mosquitoes stay outside and to increase your living comfort, Hindermann has further optimised their established fly screen curtains. The Hindermann fly screen curtains are tailored to fit every vehicle's chassis cut-outs perfectly and cover the entire opening. At the rear doors, a lead tape is attached along the bottom edge.

Sliding Door

H1 – normal roof

For sliding door with standard cut-out (short), universal size with zip in the arched door, passage on the right.

Fiat Ducato X250/X290, all models, 06/2006 – ...; Weight: 1.5 kg **500/579 299.00**

H2 – high roof

Bottom edge magnetic tape. For sliding doors with a high and wide door cut-out: universal size with zips in the arched door, only for doors on the right-hand side.

Fiat Ducato X250/X290, all models, 06/2006 – ...; Dimensions(WxH): 136x178.5 cm; Weight: 1.4 kg
500/575 299.00

Rear Door

H1 – normal roof

For rear door with standard door cut-out, can be rolled up, with two zips.

Fiat Ducato X250/X290, all models, 06/2006 – ...; Weight: 1.5 kg **500/578 289.00**

H2 – high roof

Bottom edge lead tape. Rear door with high door cut-out, can be rolled up, with two zips.

Fiat Ducato X250/X290, all models, 06/2006 – ...; Weight: 1.4 kg **500/576 289.00**

All versions are equipped with multi-path zips that can be operated from inside and outside the vehicle and make trouble-free access possible. For example, the zips for the curtain at the rear door are positioned in a way that the rear windows can be opened easily. Access to the gas cylinder cabinet or the storage room is possible without having to open the entire curtain.

Material: close-meshed, fire-retardant polyester fabric, with excellent view to the outside and good air circulation. It shields approx. 65 % of solar radiation, reducing the heat development in the vehicle significantly.



Installation rear door: The installation of the curtains is completed very quickly thanks to the magnet fixing. No buttons, no Velcro straps. The curtains can be removed just as quickly. They can stay mounted while driving. An adaption to the extension settings is not required.

Installation sliding door: The installation is done with a magnet fixing. No adaption necessary. All versions have an integrated multi-path zip that can be operated from the inside and the outside.

 Tailgate, fastening with Velcro tape.



Fly Screen Curtain VW T5/T6 Tailgate

Tailgate, fastening with Velcro tape.

VW T6, Multivan, 2015 – ..., VW T6 (incl. T6.1), transporter, 2016 – ..., VW T5, transporter, 2003 – 2015, VW T5, California, 2003 – 2015, VW T6, California, 2015 – ..., VW T5, Multivan, 2003 – 2015; Weight: 1.5 kg **500/577 289.00**



Fly Screen Door FlyTec FT 200

Single-pleated, high-quality fly screen for the sliding doors of the Fiat Ducato H2 X250/X290 and similar vehicles. Fills out the complete door area.

- Keeps out all kinds of insects and bugs
- Simple installation
- Comfortable one-hand operation
- Easy to use

Dimensions (WxH): 129.8x176 cm;

Weight: 5.5 kg **052/165 475.00**

Gutter RainTec RT 100

Everyone who has opened a sliding door while it was raining is familiar with the phenomenon of the "automatic shower". As this is not much fun, Dometic developed a **retrofit rain gutter** for vans. It drains the rainwater down the side and is additionally equipped with an **LED strip**, which solves the problem of a missing **outside lighting** in a very elegant way! For Fiat Ducato and similar vehicles. Light source: SMD LED diodes. Light colour: 3150 K (warm white). Life span: 50,000 h.

Luminous flux: 435 lm; Material: aluminium;
Nominal voltage: 12 V; Nominal capacity: 7 W;
Dimensions (WxHxD): 150x1.6x3.2 cm;
Weight: 480 g

Colour: white
Colour: black

052/160 235.00
052/162 235.00



Remote Control for LED Lamp

Remote control with dimming function for LED gutter RainTec RT 100. Convenient clamping bushes for easy installation. Max. load 8 A. Functions: On | Off | Brighter | Darker.

052/163 45.00



45.00



145.00

Rain Shield REMICare VAN

The Rain Shield keeps the entrance area of your Fiat Ducato dry. It prevents rainwater from entering your vehicle even when it is windy, which reduces the danger of slipping.

Dimensions (WxHxD): 127.2x2x16.8 cm

Weight: 850 g **052/180 145.00**



Fly Screen Door REMICare VAN

With the fly screen door REMICare VAN for the Fiat Ducato, you can enjoy plenty of light and fresh air and are protected against insects at the same time. This way, you can enjoy comfortable, ventilated camping trips without flies, mosquitoes or gnats visiting. The Fiat Ducato rain shield additionally provides a dry entrance area. This prevents rainwater from entering your vehicle even when it is windy, which reduces the danger of slipping.

Suitable for all sizes (Fiat Code: MH2, LH2, LH3, XLH2, XLH3FI only left-hand drive vehicles).

Dimensions (WxHxD): 1250x1710x96 mm

Weight: 3.51 kg **052/178 419.00**

Fly Screen Door REMICare VAN with Table Rail

Dimensions (WxHxD): 1250x1710x96 mm

Weight: 3.5 kg **052/177 479.00**



129.95



Dimatec
Best for Caravanning

Gutter for Vans

You can elegantly solve the problem of missing exterior lighting on your van with the LED aluminium profile by Dimatec. Simple installation on the upper frame of the sliding door. The LED aluminium profile with 270 LEDs provides a very nice, pleasant light. Burning time: 25,000 h.

Vehicle model: Citroën Jumper 250/290, Fiat Ducato X250/X290, Peugeot Boxer 250/290

Luminous flux: 370 lm; Nominal voltage: 12 V;

Nominal capacity: 8 W; Length: 150 cm;

Weight: 444 g **320/428 129.95**



Blackout System for Recreational Vehicles

The pleated windscreen blind was specially developed for selected recreational vehicles. Protect your private space in your vehicle from prying eyes and enjoy pleasant temperatures thanks to cold and heat insulation. The blackout system is easy to install and suitable for left- and right-hand drive vehicles. Please pay attention to your vehicle model when ordering.



DOMETIC
OUTDOOR

Fiat Ducato X250/X290

FP 300 for vehicles without rear-view mirror
500/871 415.00

FP 210 for vehicles with rear-view mirror
500/874 435.00

✓ creates a homely atmosphere
in your motorhome

MADE IN GERMANY from **385.00**

BEST SELLER



Excellent sound quality. Side panels with cut-outs for the speakers in the A-pillar.



Perfect closure – operation from bottom to top – protects your privacy.

Ford Transit V363

This robust blackout blind has been specially designed for the Ford Transit V363 Facelift models launched in June 2019. It can be adjusted from bottom to top in three positions and offers the perfect combination of privacy, shade and thermal insulation. The aluminium-coated material efficiently keeps the heat or cold outside. Installation takes just a few minutes, with flawless results. The retrofit looks like the original, installed directly at the factory.

FR 400 Ford Transit (V363), Facelift, built since 2019
500/876 385.00



The small mirror is more visible.



Easily installed in a matter of minutes!

Side Window Blackout Blind for Recreational Vehicles

from **465.00**

The set consists of blinds for the left and the right side window.

- Double-pleated honeycomb material for optimum insulation against heat and cold
- New guide panel for more privacy and better darkening
- Quick and easy to install without having to remove door components
- Approx. 40 mm left clear for better visibility of the small passenger mirror
- Ultra-flat handle for comfortable handling
- Impeccable look – like an integrated solution ex factory
- Lightweight, only 1.2 kg per side – significantly lighter than other available systems

Type	Vehicle model	Item no.	Price
SP 300	Fiat Ducato X250/X290	500/872	465.00
SP 310	Fiat Ducato X290, 2021 – ...	500/875	499.00
SP 400	Ford Transit (V363), Facelift, built since 2019	500/877	465.00



more privacy

Ford Transit (V363), Facelift, built since 2019

Front Screen Blind for Fiat Ducato

The front screen blind can easily be mounted to the dashboard without blocking the air vents. The aluminium coating on the outside of the fabric reduces heat during the day and serves as cold insulation at night. It provides privacy in the cabin area and thus serves as an anti-theft device. Black, powder-coated cassette with grey or sand-coloured blind.



✓ Protection against prying eyes,
heat and cold

Year of construction	Colour	Item no.	Price
1994 – 2006/06	grey	500/863	349.00
1994 – 2006/06	beige	500/863-1	284,-
2006/07 –	grey	500/864	415.00



Darkening System REMifront

The custom-fit darkening solution for the driver's cabin protects from prying eyes into the vehicle thanks to perfect darkening while increasing the usable living area inside the motorhome significantly. The multi-layered construction of the darkening material reduces the heating up or cooling down of the vehicle. The installation is very easy: the divided front blind is fixated to the securing points on the A-pillar provided by the

manufacturer. By means of a tube system, the blind is guided to the centre of the windscreen, the reversing mirror can remain in place. The side parts, with their pleated material are screwed into the door frames and guided by rods and profiles. When closed, the pleated material is concealed by a profile and is hardly visible. In addition, the front blind features a security locking system which prevents the front part from opening accidentally while driving. The

sturdy, high-quality darkening system is maintenance-free and features a highly light-proof pleat. It easily adjusts to potential manufacturing tolerances of the vehicle and ventilation openings are not covered. REMifront can (if not mentioned otherwise) not be used in vehicles with rain sensors, light sensors, a storage compartment underneath the roof or airbags within the A- or B-pillars or above the doors.

Vehicle model	Variant	Colour	Item no.	Price
Fiat Ducato Type 290 * 2014/05 – 2021/08	Front part without rain sensor	beige	87 230	362.00
Fiat Ducato Type 290 * 2014/05 – 2021/08	Front part for sensor package housing shape 1	beige	87 231	443.00
Fiat Ducato Type 290 * 2019 – 2021/08	Front part for sensor package housing shape 2	beige	87 234	443.00
Fiat Ducato Type 290 ** 2021/09 – ...	Front part with out sensor package	beige	87 205	362.00
Fiat Ducato Type 290 ** 2021/09 – ...	Front part for small s ensor package	beige	87 206	395.00
Fiat Ducato Type 290 ** 2021/09 – ...	Front part for large s ensor package, with or without mirror	beige	87 207	443.00
Fiat Ducato Type 250, Fiat Ducato Type 290 * 2006/07 – 2021/08	Side parts	beige	87 227	449.00
Fiat Ducato Type 290 ** 2021/09 – ...	Side parts	beige	87 211	449.00
Ford Transit 7. Gen. 2014/05 – 2019/06	Front part	light grey	87 236	495.00
Ford Transit 8. Gen. 2019/07 – ...	Front part with out sensor package	light grey	87 243	495.00
Ford Transit 8. Gen. 2019/07 – ...	Front part with sensor package	light grey	87 245	583.00
Ford Transit 7. Gen. 2014/05 – 2019/06	Side parts	light grey	87 237	455.00
Ford Transit 8. Gen. 2019/07 – ...	Side parts	light grey	87 244	455.00
Ford Transit Custom 2018 – ...	Front part without vision package.	light grey	87 273	489.00
Ford Transit Custom 2018 – ...	Front part for vision package.	light grey	87 274	579.90
Ford Transit Custom 2018 – ...	Side parts	light grey	87 275	455.00
Mercedes Sprinter 2018/03 – ...	Front part for vehicles with a small sensor housing	light grey	87 235	459.00
Mercedes Sprinter 2018/03 – ...	Front part for vehicles with a large sensor housing	light grey	87 240	459.00
Mercedes Sprinter 2018/03 – ...	Side panels for ve hicles without entry handle on the A-pillar	light grey	87 248	470.00
Mercedes Sprinter 2018/03 – ...	Side panels for vehicles with entry handle on the A-pillar	light grey	87 249	470.00
Renault Master III 2010/04 – 2019/08	Front part without rain sensor	light grey	87 228	409.00
Renault Master III 2010/04 – 2019/08	Front part for rain sensor	light grey	87 242	409.00
Renault Master III 2019/09 – ...	Front part without rain sensor	light grey	87 221 NEW	455.00
Renault Master III 2019/09 – ...	Front part for rain sensor	light grey	87 222 NEW	509.00
Renault Master III 2019/09 – ...	Front part for vehicles with assistance packages	light grey	87 223 NEW	545.00
Renault Master III 2010/04 – ...	Side parts	light grey	87 229	525.00
MAN TGE / VW Crafter 2017 – ...	Front part	light grey	87 277	535.00
MAN TGE / VW Crafter 2017 – ...	Side parts	light grey	87 279	470.00



REMIFront IV for Fiat Ducato

Suitable in design and construction for Fiat Ducato, Peugeot Boxer and Citroen Jumper built since 07/2006 with grey or beige interior. From model year 2019, the Fiat Ducato will be delivered with a new housing for the sensor package on the rear-view mirror. For this purpose, a new front part with adapted cut-out for the sensor package with housing shape 2 has been developed (item no. 87 234).

* the changeover to the Ducato model from 2021/09 does not apply to Peugeot Boxer and Citroën Jumper!
** not suitable for Peugeot Boxer and Citroën Jumper!

REMIFront IV for Ford Transit

Suitable in design and construction for Ford Transit of the 7th and 8th generation and Ford Transit Custom.

REMifront IV for Mercedes Sprinter

Suitable in design and quality for Mercedes Sprinter built since 2018/03 with large or small sensorhousing on the rear-view mirror. The side panels are available in 2 variants for vehicles with or without entry handle on the A-pillar.

REMifront IV for Renault Master

Suitable in design and quality for Renault Master, Nissan Interstar and Opel Movano built until 2021/04.

REMifront V for VW Crafter and MAN TGE

Suitable in design and version for VW Crafter and MAN TGE built since 2017.



Darkening System darkStar

This newly developed darkening system which has been designed for highest demands and is suitable for installation in a Fiat Duacto, Peugeot Boxer and Citroën Jumper built since 2006/07. The windscreen darkening differentiates between the vehicle types partially-integrated motorhomes and vans. The side window darkening differentiates between the year of construction of the vehicle. This innovative darkening systems has been developed specifically to protect your private area inside the vehicle from prying eyes. At the same time, the double-pleated honeycomb material provides pleasant temperatures by cold and heat insulation. The infinitely adjustable windscreen darkening from top to bottom makes individual light conditions possible. The darkening system is easy and quick to install and gives the vehicle a professional look. It is also suitable for vehicles with interior mirror and/ or sensors and can be used with left- as well as right-hand-drive vehicles.



Front part

Windscreen Darkening

NEW

Vehicle model	Colour	Item no.	Price
Fiat Ducato 2006/07 – ...	light grey	87 301	399.90
Fiat Ducato – Van 2006/07 – ...	light grey	87 302	399.90

Side Screen Darkening

Vehicle model	Colour	Item no.	Price
Fiat Ducato 2006/07 – 2021/08 *	light grey	87 306	469.90
Fiat Ducato 2021/09 – ... **	light grey	87 307	469.90

* the switch to the Ducato version since 2021/09 does not apply to Peugeot Boxer and Citroën Jumper!
 ** not suitable for Peugeot Boxer and Citroën Jumper!

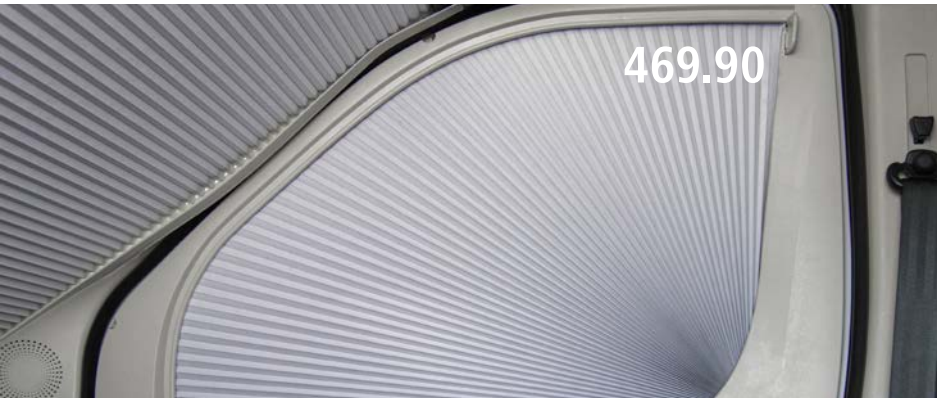

Side part



Locking side part

Rain and Wind Deflector

The rain and wind deflectors by ClimAir are delivered in pair for the front side windows and provide, thanks to them being made of high-quality cast, 3 mm thick acrylic glass, first-class quality and a multitude of advantages. With the deflectors, the side windows can remain opened, thus reducing heat accumulation inside the vehicle. Thanks to the optimised air circulation, a comfortable driving experience is offered, while disrupting wind noise is minimised. This leads to unrestricted driving comfort in every weather. The rain and wind deflectors by ClimAir are available in the colours black, smoke-grey and crystal-clear. In Switzerland, only the crystal-clear version is approved! Special orders for other vehicles as well as rear side and roof windows possible upon request!

NEW



Vehicle model	black	smoky grey	transparent	Price
Fiat Ducato, 2006/07 – ...	86 501	86 502	86 503	75.00
Ford Transit, 2014/05 – ...	86 504	86 505	86 506	75.00
Mercedes Sprinter				
2018/03 – ...	86 507	86 508	86 509	75.00
VW Crafter, 2017 – ...	86 510	86 511	86 512	75.00
VW T5 / T6 / T6.1	86 513	86 514	86 515	65.00



Tailgate Opener Air-Safe 1

The rear area cannot be aired through windows. As a result, air and heat accumulate. With the Air-Safe, the tailgate can be held open quickly and easily by approx. 10 cm and still be locked. Air-Safe is made of stainless steel (V2A) and is simply hooked into the lower locking bar so that it "extends" the original lock. Air-Safe is available for all T4, T5 and T6 models with closing aid. The simultaneous use of a FLYOUT tailgate mosquito net ensures a mosquito-free night.

214/005

25.95



25.95

✓ For Fiat Ducato built since 2006/07



34.10

EuroCarry Door Stop

Makes it possible to lock the sliding door in the half-open position. The door stops at the point where the door stop is installed. Easy installation. Incl. all screws.

052/150-1

34.10

Ventilation Grille

These universally applicable ventilation grilles are very useful in the camping sector. They can be used in many areas and are suitable, for example, for bodywork or for trailer construction. Ventilation grilles are also often used in boat building. Made of light metal. Material: aluminium



from 8.25



Dimensions (W x H)	Item no.	Price
200 x 50 mm	206/970	8.25
310 x 80 mm	206/971	12.50
440 x 200 mm	206/972	21.95
250 x 115 mm	206/975	15.95
360 x 115 mm	206/976	19.90



from 149.00

Ventilation Grille Airvent

A black, stable aluminium version for safe ventilation and rain protection at the same time thanks to the ventilation grid being oriented towards the ground. The Airvent is simply put into the opened window and fastened from the inside, after the window has been closed. Locking holes are pre-installed. Now, the Airvent can only be opened from the inside and thus acts as an additional anti-theft device.

Vehicle model	Suitable for	Item no.	Price
Fiat Ducato Type 250/290			
2006/07 - ...	Passenger's side	86 406	149.00
Fiat Ducato Type 250/290			
2006/07 - ...	Driver's side	86 407	149.00
VW T5 / T6	Passenger's side	86 404	159.00
VW T5 / T6	Driver's side	86 405	159.00
VW T6.1	Passenger's side	86 398	159.00
VW T6.1	Driver's side	86 399	159.00

Vehicle model	Item no.	Price
Citroën Jumpy, Peugeot Expert, Toyota Proace		
2016/09 - ...	86 421	139.00
Fiat Ducato Type 230	86 414	109.00
1994 - 2001		
Fiat Ducato Type 244	86 415	109.00
2002 - 2006/06		
Fiat Ducato Type 250	86 425	109.00
2006/07 - 2014/04		
Fiat Ducato Type 290	86 429	109.00
2014/05 - ...		
Ford Transit 5. / 6. Generation	86 417	109.00
2000/04 - 2014/04		
Ford Transit 7. / 8. Gen.	86 426	109.00
2014/05 - ...		
Ford Transit Tourneo / Custom	86 427	109.00
Mercedes Sprinter	86 411	109.00
1995 - 2006/03		
Mercedes Sprinter	86 428	109.00
2006/04 - 2018/02		
Mercedes Sprinter	86 432	109.00
2018/03 - ...		
Renault Master III	86 431	109.00
2010/04 - ...		
VW T3	86 420	109.00
VW T4	86 410	139.00
VW T5 / T6, VW T6.1	86 418	139.00
VW T7	86 419	159.00 NEW
VW Caddy	86 424	159.00
2004/02 - 2020/10		
VW Caddy	86 433	159.00
2020/11 - ...		
VW Crafter, MAN TGE	86 430	109.00
2017 - ...		

Ventilation Grille

Made of sturdy black aluminium for safe ventilation. It is easily inserted into the opened window from the outside and locked from the inside after closing the window. Locking holes are already integrated. It can only be opened from the inside, thus it is an additional anti-theft protection. Delivered in pairs for both driver's and passenger door.



from 109.00



The angles are inserted between windscreen and A-pillars.



The flap on the top edge of the mat is hung over the sun visors.

Internal Thermal Cover Premio

The 3-piece driver's cab insulation for Fiat Ducato built since 2006/07 provides an effective protection against cold and noise in a cosy design. The 8 mm strong foam insulation, which is equipped with a polyester velour towards the living space, creates a comfortable room atmosphere. The exterior material is coated with an aluminised polyester foil which reflects sun rays. This way, the Premio helps to effectively keep out cold in winter and heat in summer. The air cushion between windscreen and thermal cover provides additional heat insulation. The easy fastening is done with magnets. For lateral fastening, included angles are pulled behind the A-pillars and connected to the magnets which are sewn-on at the back. The flap attached to the cover's upper edge, is pulled over the sun blinds and wedged. The slightly larger-dimensioned side parts, are also fastened with shrink-wrapped magnets, the outer edges are welded in the door seals upon closing the doors. The lateral parts for vehicles with integrated interior darkening (MV) are pulled in between the frame construction of the darkening and the window. They close all around. A carrying bag is included in delivery.

HINDERMANN

OV = fits only without an installed interior darkening system
MV = fits with an installed interior darkening system

Colour	Model	Suitable for	Item no.	Price
light grey	OV	For vehicles without front darkening system	87 135	209.00
beige	OV	For vehicles without front darkening system	87 140	209.00
light grey	MV	For vehicles with front darkening system	87 141	209.00
beige	MV	For vehicles with front darkening system	87 142	209.00



Thermal Cover Set

Three-piece thermal cover set for motorhomes for insulation, darkening and noise protection. Consists of a large cover for the windscreen as well as 2 smaller covers for the driver's and the passenger's side. The 6-layered material contains insulating layers made of polyester wool and Aircap bubble wrap. The inside is grey, the exterior is made of a reflective aluminium foil. With eyelets and suction cups, the individual covers are quickly and easily attached to the insides of the windows. Delivery includes a storage bag.



For Vehicle model	Year of construction	Item no.	Price
Fiat Ducato	1981 – 1990	86 822	95.00
Fiat Ducato	1991 – 1993	86 823	95.00
Fiat Ducato	1994 – 2006/06	86 824	95.00
Fiat Ducato	2006/07 – ...	86 825	95.00
Ford Transit	2000 – 2014/04	86 836	95.00
Ford Transit	2014/05 – ...	86 837	95.00
Ford Transit Custom	2012 – 2017	86 841	95.00
Ford Transit Custom	2018 – ...	86 842	95.00
Iveco Daily	2000 – ...	86 845	95.00
Mercedes Sprinter	... – 2006/03	86 848	95.00
Mercedes Sprinter	2006/04 – 2018/02	86 849	95.00
Mercedes Sprinter	2018/03 – ...	86 850	95.00
Renault Master	1998 – 2010/03	86 853	95.00
Renault Master	2010/04 – ...	86 854	95.00
Renault Trafic	2001/07 – 2014/08	86 858	95.00
Renault Trafic	2014/09 – ...	86 859	95.00
VW Crafter, MAN TGE	2017 – ...	86 861	95.00
VW T2 / T3		86 864	95.00
VW T4		86 865	95.00
VW T5		86 867	95.00
VW T6		86 868	95.00
VW Touran	... – 2015/04	86 871	95.00
VW Touran	2015/05 – ...	86 872	95.00

without illustration: Thermal Covers, Set for VW T5 with Tailgate, Rear Section

5-piece set for the VW T5. 9-layered material made of polyester and polyethylene for insulation, darkening and noise protection. Reduced accumulation of condensation water, quick fixating via suction cups onto the inner surface of the windows. The mats provide protection against humidity, dirt and theft. The inside is grey. **87 054 159.00**

without illustration: Insulating Material, Sold per Metre

Six-layered material, including insulating layers made of polyester wool and Aircap air suspension foil. The inside is grey, the exterior consists of a reflective aluminium foil. Roll height 1.5 m, sold per running metre. **86 887 26.33 / m² 39.50**

without illustration: Suction Cup

Metal ring included.

86 889

2.20



Footwell Insulation Premio

As an effective addition to thermal covers and curtains, these mats insulate the footwell beneath the dashboard as well as the floor space between driver's and passengers seat against cold getting in and heat getting out.



Must not be used while driving!

Vehicle model	Year of construction	Form	Colour	Item no.	Price
Fiat Ducato	2006/07 – 2014/04	Standard, without cup holder	light grey	87 251	125.00
Fiat Ducato	2014/05 – ...	Standard, with cup holder	anthracite	87 254	125.00
Fiat Ducato	2014/05 – ...	Tub shape, with cup holder	light grey	87 252	149.00
Fiat Ducato	2014/05 – ...	Tub shape, with cup holder	beige	87 253	149.00
Fiat Ducato	2014/05 – ...	Tub shape, with cup holder	anthracite	87 255	149.00
Ford Transit	2014/05 – ...	Tub shape, without cup holder	light grey	87 257	149.00
Mercedes Sprinter	2006/04 – ...	Tub shape, without cup holder	light grey	87 259	149.00
VW Crafter, MAN TGE	2017 – ...	Tub shape, with cup holder	anthracite	87 256 NEW	149.00



from 129.00



Thermal Curtain for Rear Door

Custom-fit for the high H2 rear door of Fiat Ducato built since 2006/07, the insulating curtain made of a 3-layered sandwich construction (upper layer 100% polyester, bottom layer 100% polyurethane) increases the comfort within the vehicle thanks to an efficient thermal insulation. Even with the rear door being open, the outwardly pointing aluminised polyester foil does not soak up humidity. The rear door insulation is fixated along the top edge with two rows of snap fasteners. The curtain can be opened with 2 zips so that the storage space below the bed and also the gas cylinder box are comfortably accessible from the outside.

Variant	Colour	Item no.	Price
w/o window cutout	beige	87 120	289.00
w/o window cutout	light grey	87 121	289.00
with window cutout	light grey	87 283	319.00
Short version top	light grey	87 284	229.00
short version lower part	light grey	87 285	129.00

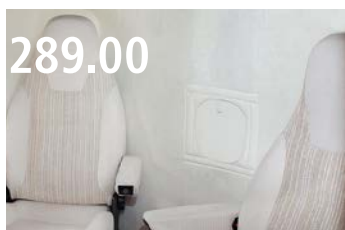

289.00

Thermal Curtain

Separates the uninsulated driver's cab of the Fiat Ducato built since 2006/07 in full height from the living area and protects against intruding cold and loss of heat (upper material 100 % polyester, backside 100 % polyurethane). Towards the



399.00



Rear Door Insulation

Developed specifically for the high rear door dimensions of Fiat Ducato from 07/2006 on. Consisting of 2 parts with inner velour coating. Is attached via magnets to doors inside the vehicle. When the doors are closed, both parts overlap in the centre to create an efficient heat insulation in the sleeping area.

Colour	Item no.	Price
beige	87 148	399.00
light grey	87 147	399.00



living space, the thermal curtain is coated with cosy polyester velour, outwards it shows a reflecting, aluminized polyester foil. It is mounted at the height of the sun visors and fastened on both sides with screw-on press studs (already integrated

top parts). An integrated, lockable flap allows for a comfortable radio access.

Colour	Item no.	Price
beige	87 114	289.00
light grey	87 117	289.00



Rear Insulating Cover Heck Breaker

Custom-made for the Fiat Ducato van built since 2006/07. Two-piece insulating cover, suitable for winter use, which provides excellent insulation thanks to its special interior fabric (Tentsulation®™), thus effectively protecting against wind and cold, but also against warmth. In winter, in particular, this creates a pleasant climate inside the van, as a lot of warmth is lost through the doors and there is draught quickly. The surface of the thermal cover is made of a robust tarp material, which is enormously tear-resistant and very easy to clean. Both parts are equipped with a detachable window insert.



from 339.00

70 % PVC polyvinyl chloride,
30 % PES polyester

Installation

Pockets are sewn into the cover's inside into both upper edges of the door parts which are hung over the door edges. At the lower edges, rubber bands are attached, which are also hung over the door edges providing a perfect fit. In the middle, both parts overlap and are fixated with Velcro and fleece straps. Moreover, eyelets are attached to the bottom edges of both cover parts left and right, with which the cover can be fixated with tensioning hooks below the vehicle.



Available in 2 Versions:

Without cut-out for rear carrier

For vehicles without an installed rear carrier. **86 806 339.00**

With cut-out for rear carrier

Specifically designed for vehicles onto which a rear carrier of the types Thule Elite Van XT or Fiamma Carry-Bike 200 is installed.

86 807 359.00



Crossbelts provide a firm hold



from 385.00

42 % PE polyethylene,
58 % PP polypropylene



Roof Protective Cover Van

Breathable roof protection tarpaulins made of Tyvek Supra-FC, whose cut sizes are specially adapted to the various vehicle lengths of the Fiat Ducato built since 07/2006 with H2 roof. For a perfect fit on the vehicle, the tarpaulins have an eyelet strip all round so that they can be ten-

sioned exactly as required by the vehicle using the standard belt system. The eyelets used have integrated reinforcement and a protective strip underneath to prevent them from coming into contact with the vehicle.

Dimensions (LxW)	Suitable for	Number of belts	Item no.	Price
450x300 cm	Vehicle length 541 cm	6	85 817	385.00
510x300 cm	Vehicle length 599 cm	6	85 818	425.00
550x300 cm	Vehicle length 636 cm	6	85 819	465.00

Tips & Tricks

The roof protection tarpaulin can also be perfectly combined with the motorhome front protection tarpaulin made from the same Tyvek Supra FC material. In addition to the roof, the front of the vehicle is also optimally protected against icing, snow and sunlight (item no. 85 663, see catalogue page 57).

+ Accessoires

35.00

Spacers

4 pieces, made of rigid foam.



85 811 35.00



Sun Protection Cover Screen

Innovative exterior cover screen, which not only provides perfect protection against the sun as well as prying eyes while viewing the outside perfectly, but which also integrates well into the vehicle's looks. The screen is hung into the door compartments at both vehicle doors and is tensioned towards the exterior mirrors or wheel housing. Rubber tensioners included in delivery.



44 % PE polyester,
56 % PVC polyvinyl chloride

HINDERMANN

Vehicle model	Year of construction	Item no.	Price
Fiat Ducato Type 250/290	2006/07 – ...	87 261	145.00
Ford Transit 6. Gen.	2006/05 – 2014/04	87 263	145.00
Ford Transit 7. / 8. Gen.	2014/05 – ...	87 264	145.00
Mercedes Sprinter	2006/04 – 2018/02	87 266	145.00
Mercedes Sprinter	2018/03 – ...	87 267	145.00
VW Crafter, MAN TGE	2017 – ...	87 269	145.00
VW T5 / T6		87 270	145.00



MADE IN
GERMANY

100 % PE polyethylene

External Insulation Mat Four Seasons

Insulation against cold in winter, protection against sunlight in summer. The mats are slipped clipped to the door edges (without screwing or drilling) and anchored with rubber straps (included). The door edges are flexible to better fit over installed darkening systems. Four Seasons are made of weather-proof thermal foil with double-sided, vaporized UV stabilised polyester foil. The front can be opened easily.



Prow Motorhome Cover Supra

All-over breathable covers not producing mouldy build-up on damp on the vehicle. They protect the engine hood against ice and snow and the interior room against direct sunlight and heating up. Also the side windows are covered to create privacy. Lightweight and smooth Supra cover remain flexible even in cold temperatures and are washable at 30 °C. Furthermore they are easy to install. Via pockets, they are put over the doors and tightened (rubber tensioners included in delivery).

42 % PE polyethylene,
58 % PP polypropylene



Vehicle model	Year of construction	Item no.	Price
Fiat Ducato Type 230/244	1994 – 2006/06	87 086	135.00
Fiat Ducato Type 250/290	2006/07 – ...	87 087	135.00
Ford Transit 6. Gen.	2006/05 – 2014/04	87 090	135.00
Ford Transit 7. / 8. Gen.	2014/05 – ...	87 091	135.00
Mercedes Sprinter	2006/04 – 2018/02	87 089	135.00
Mercedes Sprinter	2018/03 – ...	87 088	135.00
Renault Master II	2001 – 2010/03	87 093	135.00
Renault Master III	2010/04 – 2019/08	87 094	135.00
Renault Master III	2019/09 – ...	87 095 NEW	135.00
VW Crafter, MAN TGE	2017 – ...	87 097	135.00
VW T5 / T6		87 096	135.00

Vehicle model	Year of construction	Item no.	Price
Fiat Ducato Type 230/244	1994 – 2006/06	85 662	169.00
Fiat Ducato Type 250/290	2006/07 – ...	85 663	169.00
Ford Transit 6. Gen.	2006/05 – 2014/04	85 667	169.00
Ford Transit 7. / 8. Gen.	2014/05 – ...	85 668	169.00
Mercedes Sprinter	2006/04 – 2018/02	85 671	169.00
Mercedes Sprinter	2018/03 – ...	85 672	169.00
Renault Master III	2010/04 – 2019/08	85 676	169.00
Renault Master III	2019/09 – ...	85 677 NEW	169.00
VW Crafter, MAN TGE	2017 – ...	85 678	169.00
VW T5 / T6		85 679	169.00



Protection Cover

Breathable protective cover, universal fitting for camper vans with a length of 600 – 640 cm (max. width 215 cm, max. height 230 cm). The SFS-3 tarpaulin material is water repellent and thus prevents condensation and mould growth. Weight 10.5 kg. **85 758** **335.00**



100 % PES polyester

Van Protective Cover Wintertime

Fully breathable cover that protects the vehicle from negative effects such as rain, dirt, ice, heat or contamination from birds or trees. Moisture can also evaporate easily via the side surfaces. The cover is made of 3-layer SFS-3 nonwoven material (160 g/m²) and is characterised by its high tear resistance and low weight. It has been specially tailored to the proportions of the Fiat Ducato built since 07/2006 and identical models and has 4 zippers to facilitate handling and allow access to the entrance door. On the basis of the exact vehicle dimensions, the cover was dimensioned slightly larger on all sides so that any existing bicycle carriers and other projections can be easily mounted on the vehicle and still be covered. Eyelet strips on both sides, tension belts at the front and rear as well as special underbody tension belts ensure



19 % PE polyethylene,
81 % PP polypropylene

a perfect fit. In addition, a repair kit and a transportation and storage bag are included in the scope of delivery.

Vehicle length	Dimensions (L x W x H)	Number of belts	Item no.	Price
541 cm	550x210x227 cm	6	85 841	439.00
599 cm	610x210x227 cm	6	85 842	469.00
636 cm	655x210x227 cm	6	85 843	479.00



Teddy Seat Cover FF

Universal for Fiat Ducato, VW busses and also partly for fully integrated vehicles suitable teddy cloth seat cover for driver and passenger seat. The perfect fit is ensured by an elastic band attached to the back, which adapts the cover to any seat shape. Made of a 100 % cotton blend fabric (washable at 30 °C), dimensions L 165 x W 80/60 cm, weight 500 g; delivery includes armrest covers.



86 229 39.90

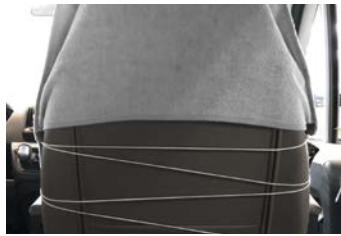

Information

Not suitable for seats with an integrated airbag!



HINDERMANN

100 % PES polyester
Alcatraz imitation suede
with FC finish

119.00



Protective Cover for Armrests

One pair, fits to the original ISRI seats' armrests without upholstery. Washable up to 30°.

Colour	Item no.	Price
anthracite	86 235	49.00
beige	86 237	49.00



Protective Cover for Original Seats

Backrest height 83.5 cm, suitable for Fiat Ducato from year of construction 07/2006 with ISRI seat, also with mounted armrests. The 2-part cover protects original upholstery from dirt and wear and tear, its upper made consists of dirt- and stain repellant Alcatraz velours imitation leather (100 % PL, with FC finishing), washable up to 30°. Armrest covers have to be ordered separately!

Colour	Item no.	Price
anthracite/ light-grey	86 232	119.00
beige/ sand	86 233	119.00

Cab Carpet Deluxe and Deluxe Security

High-quality driver's cabin carpet made of synthetic fibres with rib pattern. Highly durable version with heel reinforcement. Cut to fit each model perfectly. Specifically reinforced edges at the steering column.

Material: 100 % PP polypropylene



56.50

Carpet Deluxe

Without clamping mechanism.

for a more secure hold

Vehicle model	Item no.	Price
Fiat Ducato 230, 03/1994 – 04/2002	430/037	56.50
Fiat Ducato 244, 04/2002 – 2006	430/046	56.50
Ford Transit Generation 6, 06/2006 – 2014	430/034	56.50
Ford Transit Generation 7, 2014 – ..., Ford Transit Custom, 2012 – ...	430/126	56.50
Iveco Daily Generation 3, 2014 – ...	430/123	56.50
Mercedes-Benz Sprinter 2000 – 2006	430/052	56.50
Mercedes-Benz Sprinter W906, 04/2006 – 09/2013	430/042	56.50
Mercedes-Benz Sprinter W906, 10/2013 – 2018	430/124	56.50
Mercedes-Benz Sprinter W907/W910, 06/2018 – ...	430/043 NEW	56.50
Renault Master III, 2010 – 2014	430/041	56.50
VW Crafter Generation 1, 2012 – 2016	430/086	56.50
VW T5, 2003 – 06/2015	430/085	56.50
VW T6 (incl. T6.1), 07/2015 – ...	430/045	56.50



from 63.50

Carpet Deluxe Security

With clamping mechanism.

Fiat Ducato X250, 2006 – 04/2014	430/090	63.50
Fiat Ducato X290, 2014 – 2019	430/089	63.50
Fiat Ducato X290, 09/2019 – ...	430/088	65.50



MADE IN GERMANY

559.00

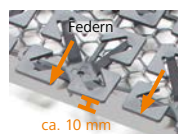
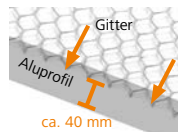

froli[®]

Use needle-nosed pliers/tweezers to wrap the Velcro connectors around the grid and the spring mat. Fixate grid and spring mat on at least 12 points.

Froli Sleeping Set for VW T5 / T6 California

The complete retrofit system consists of lying grid, spring mat, roof bed mattress and 25 Velcro connectors. It is installed in about 60 minutes: simply take out the old mattress, roll out the lying grid and the original Froli cup springs, fixate, roll out the new mattress, done!

The slatted frame serves as a base for the bed system and does not have to be removed; the lying grid prevents the springs from slipping through the slatted frame. The spring mat provides a pressure-relief support. This way, tensions and one-sided strain can be avoided. Open, breathable cells provide perfect ventilation and an ideal sleeping climate. The roof bed mattress is made of a high-quality PUR coal foam.

Features:

Overall height: 7 cm, overall weight: approx. 10.9 kg, hardness level: medium / firm, dimensions: L 200 x W 120 x H 4 cm. The cover is breathable and 30 °C washable, double cloth / Air Mesh fabric made of 100 % polyester, flame retardant. Grid and spring mat are 100 % recyclable. Reinforcement grid made of 100 % HD-PE.

Scope of delivery:

- Lying grid
- Spring mat (height: 3 cm)
- Mattress (height: 4 cm)
- 25 Velcro connectors **86 241 559.00**



NEW

MADE IN GERMANY



Protective Net SLiiPER

High safety thanks to 50 cm high net – so that parents can also sleep peacefully. Particularly suitable for motorhomes or caravans. The close-meshed net made of high-quality polyester protects the fingers of your little ones and still offers a very high visibility for parents and child.

Finely anodised aluminium profile with piping rail for variable mounting of the fastening straps. Thanks to the four different widths and the variably adjustable fastening points, SLiiPER can be installed in all common motorhomes and caravans. The children's net is delivered ready for installation.

SLiiPER was completely developed in Germany and is produced in Germany. It fulfils the requirements of DIN 1645/1646.

Installation: universal installation thanks to sliding straps for ceiling or wall with freely adjustable strap length of up to 60 cm. Up to 8 attachment points for bed base or slatted frame ensure high stability and prevent the net from slipping. Once attached, the SLiiPER can be quickly assembled and disassembled thanks to quick-release fasteners and placed under the mattress.

Scope of delivery: 2 ceiling or wall mounting brackets, net, screws, installation instructions

Size: S

Dimensions (WxH): 700x500 mm; Weight: 730 g
500/854 56.90

Size: M

Dimensions (WxH): 1000x500 mm; Weight: 1.15 kg
500/855 65.90

Size: L

Dimensions (WxH): 1500x500 mm; Weight: 1.4 kg
500/856 75.90

Size: XL

Dimensions (WxH): 1900x500 mm; Weight: 1.85 kg
500/857 99.90

Froli Bed Systems

froli[®]

Comfortable pre-assembled retrofitting systems, consisting of spring elements, which, as a modular system, are suitable for all bed sizes and slants. By clipping the elements together an orthopaedic base is formed which supports the body in both lateral and longitudinal alignment. The chambers are permeable to air and support a healthy sleeping climate without condensation. A mattress made of cold-foam with a height of approx. 10 cm is recommended.

Froli Bed Systems

Installation height 43 mm, weight 2.2 kg/m².

Dimensions (L x W)	Item no.	Price
200 x 70 cm	86 175	156.00
200 x 90 cm	86 176	189.00
200 x 100 cm	86 177	229.00

Froli Travel

Edges and bevels can be filled optimally by turning the elements or by using half elements (item no. 86 187). Height of the elements 33 mm, weight 2.6 kg/m².

Dimensions (L x W)	Item no.	Price
200 x 70 cm	86 184	158.00
200 x 90 cm	86 185	198.00
200 x 100 cm	86 186	245.00



Spring Base for Froli Bed Systems



For fixed slatted frames. Froli bed systems Star and Travel can be placed on top. Offers good air permeability. Dimensions: W 1 x L 2 m, weight: approx. 60 kg.
86 194 42.00





Quickly and easily set up!

EuroCarry Cot

The comfortable EuroCarry Cot is set up in a few minutes and is simply hooked into the interior handles in the driver's cabin. For Fiat Ducato, Citroën Jumper and Peugeot Boxer (built since 06/2006).

Belastbar bis: 50 kg, Dimensions (W x H x D): 60 x 55 x 150 cm; Pack size: 94 x 32 x 13 cm; Weight: 7 kg **250/652 527.50**

Driver's Cabin Mattress CampSleep

Comfortable, additional bed (for a person up to approx. 95 kg) which fits the measurements of the driver's cab. Thanks to the patented version and an easy folding mechanism, it is placed quickly onto the front seats (driver and passenger seat) and thus, offers another sleeping accommodation on top of the cab's seats. The 10 cm thick mattress is supported by two light plywood boards balancing the seats' shape and creating a comfortable, horizontal sleeping position. A Velcro strap provides further stability by attaching it to the passenger's door handle, keeping the broader part in front of the glove compartment in place. The robust cover is equipped with a zipper and can easily be taken off to wash it. The standard version is suitable for the Fiat Ducato and similar motorhomes, the small version is tailored to VW vans and similar.



	Dimensions (L x W x H)	Item no.	Price
Standard	160 x 73 x 10 cm	86 242	399.00
Small	148 x 64 x 10 cm	86 243	299.00

Protection Bag

Transportation bag made of steady, robust fabric to store the driver's cab mattress CampSleep. Equipped with 2 carrying straps and Velcro.



46.90

86 246 46.90

Dreamboat Campervan

The foam-filled, self-inflating mat fits perfectly into converted camping vans, such as the VW California, Marco Polo or other models. The mat's pleasant stretch upper material makes sure that you can sleep comfortably. You can choose the degree of hardness yourself, depending on how much you additionally inflate the foam-filled mat. The pack size is very compact and the mat is easy to stow away.

- Unique construction of the foam for heat regulation guarantees a comfortable mat the whole year round
- Three-dimensional shape and high profile depth for high comfort
- Incl. carry bag
- Extra durable TPU construction, no peeling of layers

Colour: night blue; Material: 100 % PES polyester



suitable for VW California, Mercedes-Benz Marco Polo and similar models

Dimensions (L x W x H): **200 x 114 x 7.5 cm**
Pack size: 62 x 24 x 22 cm; Weight: 2.9 kg **612/120 279.95**



from 279.95

incl. carry bag



new size

NEW

Dimensions (L x W x H): **190 x 150 x 7.5 cm**
Pack size: 74 x 25 x 22 cm; Weight: 4.4 kg **612/121 327.95**

SPORTSCRAFT

from 275.00



1

2



249.00

1 | Rotary Consoles for Original Seats

Vehicle model	Suitable for	Rotation	ABE/Certificate	Item no.	Price
Fiat Ducato Type 250/290, 2006/07 – ...	Driver's & passenger's side	centered	* TÜV-technical report	88 163	299.00
Fiat Ducato Type 250/290, 2006/07 – ...	Driver's Side	offset turning	* TÜV-technical report	88 147	299.00
Fiat Ducato Type 250/290, 2006/07 – ...	Passenger's Side	offset turning	* TÜV-technical report	88 148	299.00
VW T5 / T6	Driver's & passenger's side	centered	ABE	88 175	275.00
For the driver's side, the adapter item no. 88 133 is also required.					
Handbreak Adapter Driver's Seat For VW T5 / T6				88 133	22.90

* TÜV is the german association for technical inspection

2 | Special Adapter for Fiat Ducato

Flat seat box for Fiat Ducato from year 2006/07; suitable for driver and passenger side. Incl. TÜV confirmation.

88 136 249.00

Rotary Consoles CTA for Original Seats

The rotary consoles are tested following regulations ECE R14 and ECE R17. The test reports and documents can be send after ordering upon request.

All rotary consoles must be individually approved by an officially authorised expert.

from 199.00

NEW

Illustration shows item no. 88 201



44.90

3

Accessories



39.00

5



69.90

4

3 | Elevation Kit CTA Driver's Seat for Ford Transit, Built Since 2014/05

88 205 44.90

4 | Handbreak Adapter CTA Driver's Seat for Ford Transit Custom, Built 2012 – 2023

88 207 69.90

5 | Handbreak Adapter CTA Driver's Seat for VW T5 / T6

88 223 39.00

from 201.90

Seat Base Safe

The perfect safe for vans

The door can be removed after it is unlocked. The original screw connections of the seat consoles are always used for fastening. It is not necessary to drill holes into the vehicle. The dimensions of the safes ensure that the space underneath the seat is optimally utilised.



Accessories

BEST SELLER

Security Screw

 Simply exchange one of the original screws with this security screw. The screw can only be tightened or loosened with the included code nut. Suitable for Easy-Fix X 250 (item no. 250/729) and Easy-Fix X Laptop (item no. 250/720). **250/730 21.90**

NEW
252.50

Seat Base Safe VW Grand California

The safe is bolted to the driver's or passenger's seat console using the original fastening screws. No holes need to be drilled.

Dimensions (W x H x D):

38 x 12.5 x 26 cm; Weight: 8 kg

Safe opening at the front

250/744 252.50

Safe opening at the back

250/745 252.50

	Vehicle model	Dimensions	Weight	Item no.	Price
VW T4/T5/T6	VW T4, 08/1990 – 2003, VW T6 (incl. T6.1), 07/2015 – ..., VW T5, 2003 – 06/2015	25x13x33 cm	10.2 kg	250/722	201.90
Easy Fix X 250	Citroën Jumper X250/X290, Peugeot Boxer 250/290, 2006 – ..., Fiat Ducato X250/X290, 06/2006 – ...	28x18x35 cm	11 kg	250/729	237.50
Easy Fix X Laptop 17"	Citroën Jumper X250/X290, Peugeot Boxer 250/290, 2006 – ..., Fiat Ducato X250/X290, 06/2006 – ...	28x18x45 cm	11.5 kg	250/720	339.00
VW Crafter front door	VW Crafter Generation 2, van, 11/2016 – ..., MAN TGE, van, 2017 – ... TGE (2017 – ...)	32x36x12.5 cm	9.3 kg	250/733	252.50
VW Crafter rear door	VW Crafter Generation 2, van, 11/2016 – ..., MAN TGE, van, 2017 – ...	32x36x12.5 cm	9.3 kg	250/734	252.50
Mercedes-Benz	Mercedes-Benz Sprinter W907/W910, 06/2018 – ...	20x10x30 cm	3.5 kg	250/738	249.00



BORBET®

Aluminium Rims for Fiat Ducato

These aluminium rims unite a distinct look and safe driving, as they have a significantly higher load capacity than vehicle rims. Available for the Fiat Ducato built since 2006/07 in 4 versions and different designs. Special orders for other vehicles possible upon request.

215.00



■ CW5 black polished matt

■ Winterproof

190.00



■ CW5 mistral anthracite glossy

215.00



■ CW5 mistral anthracite polished glossy

NEW

for	Colour	Size	Bolt circle	HN	Offset	Max. load	Item no.	Price
CW5 Fiat Ducato Light-Chassis	black polished matt	6 x 16"	118 mm	5	68 mm	1350 kg	88 321	215.00
CW5 Fiat Ducato Light-Chassis	mistral anthracite glossy	6 x 16"	118 mm	5	68 mm	1350 kg	88 322	190.00
CW5 Fiat Ducato Light-Chassis	mistral anthracite polished glossy	6 x 16"	118 mm	5	68 mm	1350 kg	88 323	215.00
CW5 Fiat Ducato Heavy-Chassis	black polished matt	6 x 16"	130 mm	5	68 mm	1400 kg	88 325	215.00
CW5 Fiat Ducato Heavy-Chassis	mistral anthracite glossy	6 x 16"	130 mm	5	68 mm	1400 kg	88 326	190.00
CW5 Fiat Ducato Heavy-Chassis	mistral anthracite polished glossy	6 x 16"	130 mm	5	68 mm	1400 kg	88 327	215.00

from 215.00



■ CWD black polished glossy



■ CWD black glossy

■ Winterproof

342.00



■ CW7 black matt

■ Winterproof



■ CW7 bronze matt

for	Colour	Size	Bolt circle	HN	Offset	Max. load	Item no.	Price
CWD Light-Chassis	black polished glossy	6 x 16"	118 mm	5	68 mm	1320 kg	88 302	239.00
CWD Heavy-Chassis	black polished glossy	6 x 16"	130 mm	5	68 mm	1350 kg	88 303	239.00
CWD Light-Chassis	black glossy	6 x 16"	118 mm	5	68 mm	1320 kg	88 305	215.00
CWD Heavy-Chassis	black glossy	6 x 16"	130 mm	5	68 mm	1350 kg	88 306	215.00
CW7 Light-Chassis *	black matt	7.5 x 18"	118 mm	5	53 mm	1250 kg	88 310	342.00
CW7 Heavy-Chassis	black matt	7.5 x 18"	130 mm	5	53 mm	1400 kg	88 311	342.00
CW7 Light-Chassis *	bronze matt	7.5 x 18"	118 mm	5	53 mm	1250 kg	88 312	342.00
CW7 Heavy-Chassis	bronze matt	7.5 x 18"	130 mm	5	53 mm	1400 kg	88 313	342.00

* For vehicles without standard fender extensions, it must be retrofitted (item no. 87 836 or 87 837).

NEW

299.00



Fender Extensions

The fender extensions are suitable for Fiat Ducato built since 2006/07 and vehicles identical in construction. They are made of supple polyurethane, perfectly adapting to the chassis making installation effortless. With a width of 25 mm, the fender extensions optimally cover the 18" rims. Installation is done at vehicles without a

standard extension onto the original punched holes, no drilling required. Included in delivery is the required fastening material.

for	Item no.	Price
front axle	87 836	299.00
rear axle	87 837	299.00



✓ 95 % bio-based plastic



50.90



Froli

Compact Levelling Ramp Set Green Edition

Made of 95 % bio-based plastic (PE, made from renewable raw materials such as sugar cane), which means that almost no finite, petroleum-based raw materials were used.

Scope of delivery: 2 compact levelling ramps, 1 transport bag

Content: 2 pieces; Dimensions (WxHxD): 43x5x20 cm; Weight: 1.7 kg

136/140 50.90



Max. load: 3.7 t

THULE



49.00



Max. load: 5 t



✓ incl. transport bag

MILENCO



30.50

Max. load: 5 t

Levelling Ramp MGI Mini Level T1

For caravans and motorhomes. Two heights.

Content: 2 pieces; Dimensions (WxHxD):

44x11x21.5 cm; Weight: 1.9 kg

136/145 30.50

FIAMMA
home is everywhere

NEW



77.00

Max. load: 5 t

Kit Level Up Premium S

Perfect for motorhomes and vans. Same features as Kit Level Up Premium, but with smaller dimensions and a lower weight. Comes with a convenient level bag as standard.

Not intended for sale in the United Kingdom.

136/109 77.00

Levelling Ramps

Made of UV-resistant HDPE material. Three different height levels for easy levelling of the vehicle. Incl. sturdy carry and storage bag. Content: 2 pieces; Dimensions (WxHxD): 56x15x20 cm; Weight: 3.7 kg

136/130 49.00

LILIE
water | light | energy

75.00



Axle Stand Set Jumbo

Reinforced aluminium casting – no sharp edges! The axle stands are made of high-quality aluminium (rust-free), while the spindle is made of corrosion-resistant, galvanised steel. The handles are firmly anchored to the spindle in order to prevent loss.

Only for stabilising – not for lifting!

- Aluminium casting alloy
- Stackable
- Height: 28 – 43 cm
- Max. load: 2700 kg

136/102 75.00

Compensating Cushion EMUK Air-Lift®

The EMUK Air-Lift® is a highly resilient compressed air lifting cushion developed particularly for camping vehicles. All height differences between 1.5 and 20 cm can be compensated infinitely. The EMUK Air-Lift® can bear a load of up to 11 t. It is very easy to use. The cushion is simply placed beneath the wheel you want to lift and levelled with a hand/foot pump or a 12 V mini compressor. The particularly thick rubber skin gives the air cushion sufficient protection against external impact from stones, rubble or shards. The ribbed profile makes sure that the wheels you want to lift do not slip. On request also available for twin tyres.

Technical data:

- Load capacity 11 t at 6 bar
- Height (inflated) 1.5 – 20 cm
- Inflating & deflating one car valve
- Applicable in temperatures from -20 °C to +60 °C



Max. load 11 t

from 269.00



✓ Smooth height adjustment!



	Item no.	Price
1 pieces	136/148	269.00
2 pieces	136/149	499.00



MILENCO

179.00

✓ Replacement mirror for the original Fiat Ducato mirror. Fits perfectly!

Electric Replacement Mirror Fiat Ducato

Electrically adjustable replacement mirror for the Fiat Ducato/Peugeot Boxer (all models built since 2006). Without sensor. With E certification mark. Mirror (B x H): 375 x 225 mm; Arm length: 250 mm Content: 1 pieces; Weight: 3.8 kg

left-hand	136/720	179.00
right-hand	136/721	179.00



✓ Perfect protection

109.90

Mirror Protection

These mirror covers are manufactured to fit perfectly over the motorhome mirror housing to protect the mirror against accidental damage. A screw on the clamp ensures a safe and secure fit. Fulfills all vehicle safety standards. Fits Fiat Ducato built since 2007, Peugeot Boxer and Citroën Relay with wide arm mirrors. Content: 2 pieces

Ducato 2007 ... black	136/767	109.90
Ducato 2007 ... white	136/766	109.90
Transit 2014 ... black	136/818	109.90
Transit 2014 ... white	136/817	109.90



38.90

Rear-View Mirror Retral

Special rear-view mirror. Manufactured to keep the interior of campers and motorhomes under control. Suitable for families with children and/or pets to keep an eye on them. Stable and robust plastic structure. Quick and easy installation via suction cup. The mirror can be tilted effortlessly to adjust it perfectly.

Mirror (B x H): 145 x 60 mm; Content: 1 pieces; Weight: 146 g **136/910 38.90**



from 459.00



Step

The steps are suitable for the original driver's cabs of Fiat Ducatos built since 2006, Mercedes Sprinters built since 2006 and VW Crafters built between 2006 and 2016 as well as of vehicles with identical construction. Aluminium profile with screwed synthetic safety cover at the edges and anti-slip profile. The steps are screwed safely to and under the vehicle's crossbeam via the vehicle-specific brackets included in delivery. **The problem:** Due to their construction, the Fiat Ducato's, Sprinter's and Crafter's first steps are situated inside the driver's cab at a height of 46 – 51 cm above ground. To surmount this height difference, drivers often misuse their steering wheel to climb into the vehicle. This is not possible for the passenger, as no such aid is within their reach.

Due to the height difference of 46 – 51 cm, climbing into the vehicle is uncomfortable and tiring.

The solution: With these steps, the height difference is cut down to approx. 23 cm. The steps are adaptable and vertically adjustable to the existing vehicle construction. This is done via entirely vertical profiles at the bottom of every step. Thus, the set of steps can be adjusted specifically to the different vehicle bodies.

Consists of: 2 anodised aluminium steps (driver's and passenger's side); 2 sets of stainless steel brackets; fastening material; manual illustrated in colour; drilling template; Vehicle Type Approval; maximum bearing load per step: 140 kg.

Fiat Ducato	136/010	459.00
VW Crafter, MB Sprinter	136/011	479.00



89.90

✓ Solar light



150 KG

✓ Level compensation

Boxstep NG

Caravan entrance step with internal storage space for shoes, accessories, tools, etc. The lockable, waterproof lid is equipped with a non-slip tread and an integrated safety solar light. Very sturdy high-quality plastic construction with adjustable feet for level adjustment. Material: plastic

Dimensions (W x H x D): 58 x 24.5 x 38 cm		
Weight: 3 kg	400/765	89.90



25.90

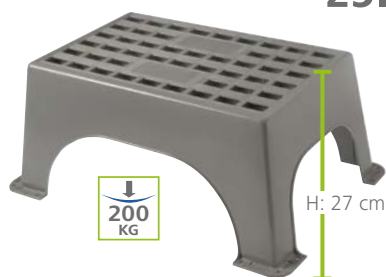

200 KG

H: 27 cm

Step Caravaning

Step for caravans and motorhomes made of high-quality plastic. The extra large tread makes it safe to use. TÜV-tested according to DIN EN 1645-1 and DIN EN 1646-1.

Material: plastic, maximum bearing load: 200 kg		
Dimensions (W x H x D): 45 x 27 x 24 cm; Weight: 1.4 kg	400/768	25.90



150 KG

76.90

GoStep NG

Very sturdy step with folding legs. Solid construction made of powder-coated aluminium. High stability. Large anti-slip surface. Very compact dimensions. XL version with enhanced safety thank to generously enlarged tread.

Dimensions (W x H x D): 47.5 x 23 x 30 cm		
Weight 2.65 kg	400/759	76.90



from **389.00**

	Width	Weight	Item no.	Price
1 Slide-Out Step G2 12V *	407 mm	5.8 kg	89 346	389.00
Slide-Out Step G2 12V *	552 mm	6.6 kg	89 347	449.00
Slide-Out Step G2 12V *	707 mm	7.7 kg	89 348	519.00
2 Slide-Out Step G2 12V Ducato **	407 mm	5.8 kg	89 350	399.00
Slide-Out Step G2 12V Ducato **	552 mm	6.5 kg	89 351	459.00
Slide-Out Step G2 12V Ducato **	707 mm	7.5 kg	89 352	529.00
3 Slide-Out Step G2 12V VW Crafter **	552 mm	6.5 kg	89 354	459.00
Slide-Out Step G2 12V VW Crafter **	707 mm	7.5 kg	89 355	529.00



* For the installation, vehicle-specific installation sets are available.

** special version for the Fiat Ducato. VW Crafter and MAN TGE, for installation, an installation set is a must

1 Slide-Out Step G2 12V

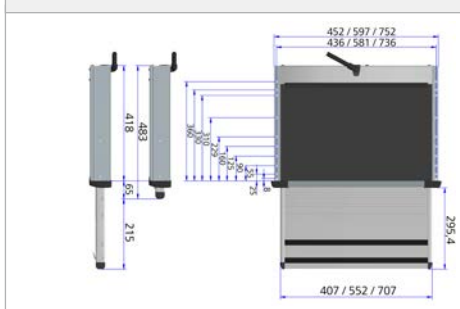

2 Slide-Out Step G2 12V Ducato

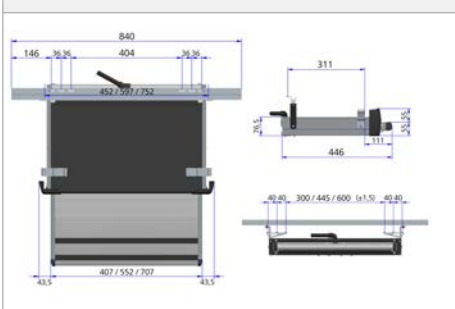

3 Slide-Out Step G2 12V VW Crafter

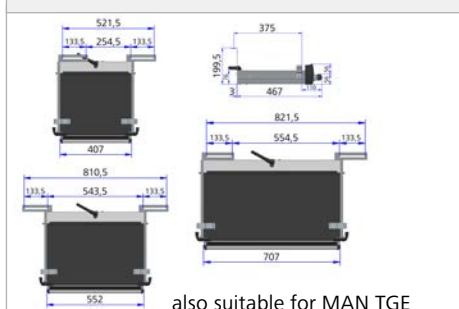

+ Accessories



from **54.00**

LED Step Illumination

Flexible LED stripe integrated for ideal illumination of the stepping area into them. Capable of retrofitting an Thule Slide-Out Step V12 12V (from series built since 2013) and V18 as well as onto a Thule Slide-Out Step G2 12V. Protected from intruding dirt or splashing-water in accordance with sealing class IP65. Length of 67 cm, can be cut effortlessly to the individually needed length.

Scope of delivery:

LED stripe, standard front profile, satin-finished synthetic lens, dirt-remover brush, end caps.

Model	Item no.	Price
Standard	89 380	54.00
Ducato	89 391	57.00

w/o illustration: Installation Set Thule Slide-Out Step G2 12V for Fiat Ducato

To install the Thule Slide-Out Step G2 12V onto the Fiat Ducato built since 2006/07.

89 357 99.00

w/o illustration: Mounting Set Slide-Out Step G2 12V

To install the Thule Slide-Out Step G2 12V onto the Ford Transit, Mercedes Sprinter, Renault Master.

Vehicle model	Item no.	Price
Ford Transit 2006/05 – 2014/04	89 376	99.00
Ford Transit * 2014/05 – ...	89 377	99.00
Ford Transit ** 2014/05 – ...	89 379	99.00
Mercedes Sprinter *** 2006/04 – ...	89 381	101.00
Renault Master III 2010/04 – ...	89 382	99.00

* with front-wheel drive

** With all-wheel drive

*** with rear or all-wheel drive

w/o illustration: Montage-Set Slide-Out Step G2 12V for VW Crafter and MAN TGE

Vehicle model	Width	Item no.	Price
VW Crafter 2017 – ...			
MAN TGE 2017 – ...	552 mm	89 358	101.00
VW Crafter 2017 – ...			
MAN TGE 2017 – ...	707 mm	89 359	101.00

w/o illustration:

Relay for Thule Steps 12V

When the engine is started, the step retracts automatically.

89 390 18.00

Control Box for Thule Steps 12V

Thanks to a door contact switch, the step extends and retracts automatically when the door is closed or opened, and retracts as well, when the vehicle is started.

89 387 289.00



THITRONIK® stands for safety

from 429.00



Wireless Alarm System WiPro III & WiPro III safe.lock

Wireless alarm system for motorhomes, compatible with CAN bus.

Simple and convenient protection. The alarm system for motorhomes does not have disturbing motion detectors and protects the vehicle effectively using tamper-proof wireless magnetic contacts. This prevents false alarms and you can use the alarm system when it matters most – with you present! For example, the WiPro III safe.lock makes it possible for many vehicle types to also operate the vehicle's central locking system with the wireless hand-held transmitter. When using a networking module or a Pro-finder, this can even be done via an app. Alternatively, you can control the WiPro III safe.lock with the NFC module. The integrated interior siren in conjunction with the vehicle horn or an optional siren ensures the necessary attention. The WiPro III's sophisticated jammer detection prevents sabotage with so-called "jammers", which cause interference with conventional wireless alarm systems and connected wireless sirens.

Scope of delivery:

WiPro III or WiPro III safe.lock control panel, status LED, wireless hand-held transmitter 868, wireless magnetic contact 868 black, wiring harness, installation material, warning sticker, manual

WiPRO III "safe.lock"

Iveco Daily 2 after Facelift 2006, Opel Movano C, 2021 – ..., Fiat Ducato X250/X290, Citroën Jumper X250/X290, Peugeot Boxer 250/290
214/192 479.00

Ford Transit Generation 7, 10/2019 – ...

Prerequisite: switch lock can be activated in the vehicle menu. **214/170 479.00**

VW Crafter Generation 2, 11/2016 – ..., VW T6 (T6.1), 2019 – ..., Mercedes-Benz Sprinter W907/W910, 06/2018 – ..., MAN TGE, 2017 – ... **214/130 479.00**

NEW

Technical data:

Power supply 12/24 V, current consumption approx. 11 mA, alarm sound approx. 102 dB, dimensions (W x H x D): 80 x 29 x 80 mm, weight: approx. 90 g

WiPRO III

Ford Transit Generation 7, 2014 – ..., Ford Transit Generation 6, 06/2006 – 2014

214/251 429.00

Mercedes-Benz Sprinter W906, 04/2006 – 2018, VW Crafter Generation 2, 11/2016 – ..., Mercedes-Benz V-Class W447, 2014 – ..., VW Crafter Generation 1, 2006 – 11/2016, MAN TGE, 2017 – ... **214/252 479.00**

Renault Master II, 2003 – 2010, Renault Master III, 2010 – ..., VW T6 (incl. T6.1), 07/2015 – ..., VW T5, 2003 – 06/2015 **214/253 429.00**

Special features:

- Simple, intuitive handling: vehicle locked/alarm system armed
- Wireless magnetic contacts without wiring!
- No interference-prone motion detectors
- Staying in the vehicle possible without deactivating sensors
- Control of the alarm centre via wireless vehicle key and wireless hand-held transmitter
- Easy add 2.0: subsequent coupling of wireless accessories via wireless hand-held transmitter or car doors
- Panic alarm function
- Also suitable for vehicles without CAN bus
- Battery life of the wireless accessories approx. 2 years
- Up to 100 wireless modules can be linked
- Radio range of up to 75 metres (free field)
- Copy-proof thanks to over 4 billion codes
- Protection against replay attacks
- Anti-jamming! jammer detection
- Remote alerting and localisation with Pro-finder (optional)

Download the THITRONIK® app now and connect it to the WiPro III alarm system!

- ✓ Arming/disarming the alarm system
- ✓ Locking/unlocking*
- ✓ Locating the vehicle with GPS**
- ✓ Remote immobilisation of the vehicle**
- ✓ Teach-in mode for radio modules
- ✓ Many other functions



*only in conjunction with WiPro III safe.lock and BLUETOOTH® networking module or Pro-finder
**only in conjunction with Pro-finder



List of compatible vehicles





✓ The right accessories for WiPro III safe.lock & WiPro III



from 91.00

Wireless Cable Loop 868

For securing mobile goods outside of your vehicle (e.g. bicycles, mobile satellite antennas, camping furniture, etc.). Sets off an alarm if severed or sabotaged. Voltage supply 3 V (CR2032), frequency 868.35 MHz, range approx. 75 m.

Cable length: 2,5 m

white	214/257	91.00
black	214/263	91.00

Cable length: 5 m

white	214/260	97.00
black	214/264	97.00



69.00

Wireless Magnetic Contact 868

Self-adhesive wireless magnetic contact for securing windows, doors, storage compartments, roof boxes, hatches, etc.

white	214/255	69.00
black	214/254	69.00



125.00

Wireless Gas Alarm 868

For connection to 12/24 V. Wirelessly reports narcotic gas attacks and gas leaks (propane/butane) to the WiPro III or to the WiPro III safe.lock. Processor-controlled temperature compensation and sensor self-test ensure that it works reliably.



88.00

safe.lock Conversion Circuit Board

In conjunction with the WiPro III safe.lock, it closes the security gap on the vehicle side caused by uncoded vehicle keys (Fiat Ducato, Citroën Jumper, Peugeot Boxer, Iveco Daily from 2006 – 2018).

214/194 88.00



69.00

Portable Transmitter WiPro III

Enables the operation of the alarm system and the central locking system in combination with the WiPro III safe.lock. Protected by 4 billion changing codes, the vehicle can be securely locked/unlocked.

214/195 69.00



17.00

Mounting Adapters (2 Pairs)

For optimal assembly of wireless magnetic contacts on door seals of storage compartments (set consisting of 2 pairs). Recommended for use with wireless magnetic contacts on tailgates.

white	214/197	17.00
black	214/081	17.00



from 39.00

Additional Siren

Additional siren for WiPro III. Suitable for installation in the engine bay or car cabin. Also available as a battery-buffered siren (310/872).

Additional Siren	214/259	39.00
Backup Siren	310/872	49.00

Network Interface Module

This sophisticated BLUETOOTH® module optimises your THITRONIK® security system: Operate all remotely controllable functions of the WiPro III conveniently with your smartphone/smartwatch. This is possible with the Thitronik network interface module. Connect your smartphone to your WiPro III alarm system and operate it within close range of your motorhome via BLUETOOTH®. Authorised users can easily activate and deactivate the system at any time. Owners of a WiPro III safe.lock, which also accesses the existing central locking system, can open and close the vehicle without a vehicle key or remote control. The network interface module can also be integrated if the Pro-Finder locating system is installed.

Special features:

- Control the WiPro III via BLUETOOTH®
- Control the central locking system via smartwatch or smartphone (only in combination with the WiPro III safe.lock)
- Easy add 3.0: subsequent connection of wireless accessories via app

129.00



Control via smartwatch ...

... or app



Technical data:

Power supply: 12/24 V, Bluetooth® 5.0 low energy, temperature range: -20 °C – +80 °C, radio range

(free field) approx. 10 m.

Dimensions (W x H x T): 52 x 25 x 56 mm; Weight: 70 g

214/188 129.00



G.A.S.-pro III

The G.A.S.-pro III is available in 2 basic setups: one with an integrated liquid/knockout gas sensor and one with an integrated CO detector. Both versions can be combined with an additional gas or CO detector. The equipment is technically unique in the field of vehicle gas warning devices: its power consumption is reduced to a minimum of 26 mA with a liquid gas/knockout gas sensor and to just 9 mA with a CO gas sensor. The internal siren sounds at a penetrating 94 dB, while an integrated humidity sensor optimises the already precise measurement in the event of high humidity in the vehicle or breathing air in the immediate vicinity of the sensor. Precise temperature adjustment is mandatory. In addition, an alcohol filter function eliminates false alarms caused by alcohol in the air. Thanks to the integrated radio unit, the G.A.S.-pro III communicates with the WiPro III alarm system without additional wiring.

G.A.S.-pro III at a glance

- Gas detection according to **DIN EN 50194-2**

- Gas detection according to **DIN EN 50291-2** (CO version)
- CI-Bus compatible
- Detects propane and butane, narcotic gases or carbon monoxide (depending on the version)
- Permanent compensation of temperature and humidity
- Regular self-test to check functionality
- Alarm output/siren output
- LED display for both sensors

Technical data

Current consumption: 9 mA (CO)/26 mA (liquid/knockout gas); sensor inputs: 1 internal, 1 external; sensitivity: 50 ppm (CO) 700/1400 ppm (butane); sound pressure: 94 dB (internal siren); temperature range: -20 °C +60 °C

G.A.S.-pro III	310/850	279.00
Knockout gas and liquid gas		
G.A.S.-pro III – CO	310/849	279.00
Carbon monoxide		



279.00

+ Accessories

CO Detector	310/862-1	99.00
Additional Sensor	310/848	65.00
Additional Siren	214/259	39.00

Pro-finder

In the event of an attempted break-in, Pro-finder alerts you via SMS or call on up to 10 mobile phones. Depending on the installation, the stolen vehicle can be shut down via app. The status of the alarm system and its in- and outputs can be retrieved and changed at any time via app. Low battery voltage of the supply voltage source is also reported via SMS. Thanks to the two outputs, features such as your stationary heating or your AC can be remote-controlled. Pro-finder can also be used without WiPro III for locating, controlling and monitoring. Your Thitronik premium partner will provide you with a suitable SIM card with an attractive basic fee.

Special features:

- Receive alerts via SMS or call
- Locate your stolen vehicle
- Can also be used without an alarm system
- Remote control of alarm system via SMS or phone call
- Geofencing (virtual fence) by WiPro
- Easy add 3.0: subsequent connection of wireless accessories via app
- Low monthly costs (only SIM card fees or prepaid cards)
- SMS costs are incurred only with a real alarm



(SIM card must be SMS, telephony and data-capable)

- 2 connecting transistor outputs
- Integrated GPS receiver and GSM antenna
- Voltage monitoring
- Special caravan mode
- Integration of Büttner Elektronik batteries, consumer switch-off in case of deep discharge, battery monitoring with undervoltage alarm

Scope of delivery:

Pro-finder, quick guide, connection cable, installation material

Technical data:

Voltage supply: 12/24 V; current consumption transmission: approx. 16 – 21 mA; current consumption standby: approx. 25 mA; transmission frequency: quad band; number of destination call numbers: up to 10; interface: RJ10 (input for WiPro); outputs: 2 x open collector (max. 0.5 A). Dimensions(WxHxD): 103x30x96 mm; Weight: 110 g



GPS-pro as an additional (external) GPS antenna. It is used when the internal GPS receiver of the Pro-finder is concealed, for example, by metal parts and therefore has no reception.

External GSM Antenna

In areas with poor reception, this antenna provides a reliable mobile connection. Simply screw it into the antenna jack in place of the rod antenna and fasten it with the self-adhesive backing in an inconspicuous place. Technical data: gain: 2.1 dB.

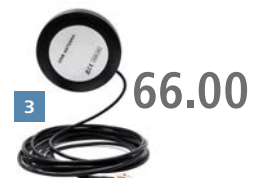

	Item no.	Price
1 Pro-finder	214/190	479.00
2 GPS-pro	214/191-1	129.00
3 External GSM Antenna	214/190-1	66.00
w/o illu. Shut-Down Control	214/175	35.00

NFC Modul

Attention outdoor enthusiasts, sportsmen and globetrotters – attached to the inside of your vehicle window, the NFC module, as a virtual key, is the perfect control solution for your WiPro III, WiPro III safe.lock and WiPro easy alarm system. Conveniently arm and disarm your alarm system with the included transponder card or with the robust, waterproof accessories, such as a wristband, a key fob or a compatible credit card. Owners of a WiPro III safe.lock can additionally access the central locking system and unlock and lock the vehicle without a key. The NFC module can be retrofitted as an accessory at any time.

Scope of delivery: NFC module, batteries, transponder card, quick guide



167.00



Technical data:

NFC accessories use MIFARE DESFire and are encrypted with a security code for maximum security. Power supply: 3 x alkaline AAA battery. Temperature range: -10 °C to +70 °C. Dimensions (H x ø): 19.5 x 89 mm. Weight: 150 g

214/171 167.00



NFC Transponder Card	214/172	19.00
NFC Tag	214/173	19.00
NFC KeyStrap M, black	214/174	25.00
NFC KeyStrap M, white	214/131	NEW 25.00
NFC KeyStrap L, blue	214/137	NEW 25.00



Gas Warner 3-Sicur, 12 V

Gas warning device for recreational vehicles with highly sensitive sensors for propane/ butane, carbon monoxide and knockout gases, which in case of need sound the alarm via an acoustic signal. Calibrating the individual sensors is automatically done. A buffer battery (item no. 322/7444, see catalogue page 574) ensures the functionality of the device even when the on-board power breaks down. Can be used mobile

or installed permanently. The operation is very simple - all functions such as turning on, off, test, reset, are all controlled via one button. With LED control lamp and 12 V cigarette lighter plug.

Technical data:

Supply voltage 12 V; power consumption stand-by: 0.5 W, power consumption alarm 0.9 W, dimensions W 11 x H 4 x D 7 cm, cable length 110 cm.

NEW



87 199

99.90

Gas Warning System TriGasAlarm

Gives warning of escaping propane, butane, and narcotic gas. The highly sensitive sensor signals even the slightest gas concentration. Proper functioning is always checked when the system is turned on, the automatic calibration checks the settings every 40 seconds and corrects them if necessary. Through optical (change of colour: green-red) and acoustical signals, the system check, the standby state as well as the alarm is displayed. By a quick tip on the on-/off-switch the brightness of TriGas in standby state can be dimmed.

Technical data:

Operating voltage 9 – 16 V, power consumption in standby mode: 95 mA, in alarm mode: 160 mA, sensitivity 98 ppm, sound level of the alarm: approx. 80 dB, dimensions W 9 x H 4 x D 9 cm, weight: approx. 120 g.

87 191

99.00



99.00



49.00



Additional Sensor for TriGasAlarm

Optionally a second sensor can be connected to the TriGasAlarm system. The additional sensor has the same technology as the built-in one and is used as an addition e. g. in large motorhomes. In cooperation with both sensors a secure detection of rising or falling gases is guaranteed. Cable length: 2.5 m.

87 192

49.00

Information

The proper function of the device is only guaranteed when using a vehicle battery. Operation with a power supply or a charger can cause malfunctions.



from
249.00

Door Safe Fiat Ducato

The door safe is installed in the original Fiat driver's cab doors. The safe is locked with tried and tested high-quality locks made in Germany. Comes with a mat to cover the door.

Scope of delivery: safe, fastening material, installation instructions

Peugeot Boxer 250, 2006 – 04/2014, Fiat Ducato X290, 2014 – 2019, Citroën Jumper X250, 2006 – 04/2014, Fiat Ducato X250, 2006 – 04/2014

Dimensions (W x H): 10.5 x 21 cm; Weight: 5.5 kg

250/742

249.00



Citroën Jumper X250/X290, Peugeot Boxer 250/290, 2006 – ..., Fiat Ducato X290, 2019 – 2021

Dimensions (W x H): 9.5 x 17 cm;

Weight: 4.5 kg

250/743

249.00

Fiat Ducato X290, 2014 – 2019, Fiat Ducato X250, 2006 – 04/2014

Dimensions (W x H x D): 55 x 14 x 33 cm; Weight: 7 kg

250/731

322.50

Citroën Jumper X250/X290, Peugeot Boxer 250/290, 2006 – ..., Fiat Ducato X290, 2019 – 2021

Dimensions (W x H x D): 54 x 13 x 33 cm;

Weight: 7 kg

250/737

322.50

Door Safe Fiat Ducato

The door safe is installed in the original Fiat driver's cab doors. The safe is locked with tried and tested high-quality locks made in Germany. Comes with a mat to cover the door.

Scope of delivery: safe, fastening material, installation instructions

Passenger Door Safe

Dimensions (W x H x D): 27.5 x 7 x 16.5 cm; Weight: 3.5 kg

250/740

269.00

Fiat Ducato X290, 2021 – ...

Dimensions (W x H x D): 26.5 x 10 x 11.5 cm;

Weight: 4.2 kg

250/739

249.00



Door Lock Elephant 9

The Elephant prevents forceful, unauthorised opening of the motorhome door from the outside. The lock is inserted from the inside between the lock and the strike plate when the door is closed. This means that the door cannot be opened either from the outside or from the inside.

- No drilling
- Lightweight (stainless steel)
- Immediate safety
- Simple operation
- Protected interior
- Invented by campers for campers

For the rear door of the Fiat Ducato, Peugeot Boxer, Citroën Jumper built since 06/2006 and Opel Movano C built since 2021. For normal roof and high roof variants H1/H2/H3.

Scope of delivery: 1 sheet metal bracket bent left, 1 sheet metal bracket bent right, 1 safety split pin 45 mm, installation manual.

214/329

44.50

44.50



from 249.00



33.90

Mobil-Safe

BEST SELLER

MADE IN GERMANY

Protective Plate Door Handle Eurochassis

Screwdrivers can no longer be driven between the door handle grip plate and the sheet metal in order to get to the underlying linkage of the lock mechanism. Suitable for Iveco Daily built since 2014, Fiat Ducato built since 06/2006 and identical vehicles. Suitable for driver's door, passenger door, side door and tailgate. Two parts for easy installation. Material: stainless steel; Dimensions (WxHxD): 160x2x240 mm; Weight: 210 g

250/736 33.90

MILENCO

Anti-Theft Device BC Lock

Encloses and locks the brake and clutch pedals, rendering them inoperable. With high-quality protective foam base and high-security lock (drill- and cut-resistant). Fits in seconds. Material: steel; Weight: 1.5 kg



149.50

Ford Transit, all models with automatic transmission built since 2013 – ..., Mercedes-Benz Sprinter W906, 10/2013 – 2018 **127/484 149.50**
Ford Transit, all models built since 2013 **127/490 149.50**

Peugeot Boxer 250, Citroën Jumper X250, Fiat Ducato X250 2006 – 2014 **127/485 149.50**

Citroën Jumper X250/X290, Peugeot Boxer 250/290, 2006 – ..., Fiat Ducato X290, with manual transmission, 2014 – ... **NEW 127/486 149.50**

Citroën Jumper X250/X290, Peugeot Boxer 250/290, 2006 – ..., Fiat Ducato X290, with automatic transmission, 2014 – ... **NEW 127/487 149.50**



from **98.00**

Van Lock

Secures the sliding and rear doors of your van.
• Suitable for all vehicles
• Made from premium aluminium with powder coating
• Keyed alike
• Dimensions (WxHxD): 15x4x5.5 cm;

Content	Weight	Item no.	Price
1 pieces	525 g	214/321	98.00
2 pieces	1.13 kg	214/320	186.00



from **98.00**

Thule Universal Lock

• Large overlap at the door for more safety
• Up to 3 locks with unified key available
• For left and right hinged doors and service doors
• **3 different installation options**
• **Surface installation** for sliding door, driver's and passenger door and the rear door of a van
• **Wall installation** or **door frame installation** for entrance door, garage or the service door of a motorhome or caravan.

• Dimensions (WxHxD): 21.1x7x3.6 cm
• Weight: 760 g

Content	Colour	Item no.	Price
1 pieces	white	214/322	98.00
2 pieces	white	214/323	186.00
3 pieces	white	214/324	279.00
1 pieces	black	214/325	98.00
2 pieces	black	214/326	186.00

HEOSafe® Van Security Paket Fiat Ducato X250/290

The HEOSystem package is the ideal solution for installing several HEOSafe® locks with the same key.

The set of additional locks is perfect for your van. The locks are also suitable for sliding, rear and wing doors.

Consists of: 1 x lockable HEOSafe® door lock for the interior of Ford Transit cab doors from 2014 onwards (type 14656) and 2 x HEOSafe® Van Security (type 1760) for securing sliding and rear/wing doors.

Ford Transit Generation 7, 2014 – ...

silver grey	214/163	337.00
white	214/165	337.00
black	214/164	337.00

Fiat Ducato X250/X290, all models, 06/2006 – 2021

silver grey	214/068	337.00
white	214/089	337.00
black	214/069	337.00

HEOSolution
convenient security tech & accessory

white +2x

silver grey

black

337.00

Fiat Ducato X290, 2021 – ...

silver grey	214/106	337.00
white	214/108	337.00
black	214/107	337.00

Replacement Inner Handle for Sliding Door Right

Replace your standard door handle with the new HEOSafe® handle! With an ergonomic design, modern and handy, it ensures easy and quick opening of your sliding van door. Made of high-quality material and very robust – the best solution!



NEW

214/090 19.90

Sliding Door Lock

Citroën Jumper X250/X290, Peugeot Boxer 250/290, all models, 2006 – ..., Fiat Ducato X250/X290, 06/2006 – ...
HEOSafe® VAN interior lock for sliding doors.

Additional locking of the sliding door from the inside. By operating the lever forwards, the door is secured. To unlock and open the sliding door at the same time, simply push the handle backwards. HeoSafe® Type: 1763 **214/088 89.00**



89.00



Checklist – Traveling Safely by Van



To make sure that your van trip doesn't turn into a horror trip, we have put together a short checklist of the most important things to think about before setting off on your journey:

Vehicle

- Check operating fluids (oil, coolant)
- Look in the engine compartment, check hoses for e.g. signs of marten bites (*MC, page 367)
- Check tire pressure
- Check if spare tire is available and in order
- Check for the availability of spare fuses, spare bulbs
- Do you have your warning triangle, rear warning sign (page 30), high-visibility vests (*MC page 263)?
- Do you have a tow rope?
- Do you have your on-board tools?
- Check the availability of a fuel canister (*MC page 262)
- Do you have a fire extinguisher? (*MC page 263)?

Burglary and theft protection

- Do you have a safe for your valuables, installed e.g. under the driver's seat or in the door (page 61, 69)?
- Do you have additional window and door security measures in place (page 70)?
- Do you have an alarm system on board (page 66 – 68)?
- Do you have a gas warning device (page 68 – 69)?

Supply

- Check the water circuit for leaks
- Check the gas circuit for leaks
- Check your battery capacity

Documents

- Driver's license
- ID or passport
- Visa (if necessary)
- Vaccinations, vaccination certificate

Health

- Do you have the mandatory first aid kit for traffic participants (*MC page 263)?
- Do you have your personal first aid kit or important medicines?
- Do you have everything for water sterilisation (*MC page 387 – 394)?
- Do you have your disinfectants (page 72)?
- Do you have your insect screens (page 48 – 49)?

Sun protection:

- Did you pack sun cream?
- Do you have a hat?
- Do you have something to shade your vehicle with, e.g. an awning or a sunblock (page 16 – 18, 28)?

Other

- Do you have a spare key?
- Do you have a smart phone with a charging option?
- Did you pack a torch (*MC 108 –109)?
- Do you have wheel chocks or shims (page 63)?
- Did you pack a foldable spade (*MC page 75)?
- Do you have duct tape (*MC page 374)?

Route planning

- Plan your route according to the vehicle
- Make sure your navigation system has the appropriate software for recreational vehicles (page 121 – 124, 126 – 127)
- Do you have your maps and information material?

To check directly before departure

- Are your gas cylinders closed?
- Are the vehicle's superstructures and attachments folded in?
- Are the satellite system, roof rent and folding roof retracted?
- Is the luggage outside securely fastened, e.g. Bikes?
- Is the luggage inside securely packed into e.g. storage compartments?
- Is the vehicle's payload appropriate (*MC page 284)?
- Do children and animals have a safe seating position?

*MC = Frankana Freiko main catalogue



83.90

With power



Portable Shower for Vehicles

Everything on board:

- 1 canister (20 l)
- Submersible pump 12 V with reversing cable 4 m and cigarette lighter plug
- 1 hand shower, with 2 m hose

300/662 83.90

26.90



BIOLYSAN Tank Cleaner

BIOLYSAN® Tank Cleaner 100 ml is suitable for disinfecting water tanks and pipes in motorhomes, caravans and boats with a tank capacity of up to 60 litres. The tank cleaner complies with the German Drinking Water Ordinance. We recommend carrying out a basic disinfection of the entire water installation twice a year. BauA reg. no.: N-94602



Biozid

300/974 10.95



BIOLYSAN Water Hygiene – 10 x 10 ml Disinfectant

BIOLYSAN® Water Hygiene for the disinfection of drinking water. Practical and easy to use. Add one vial to 40 litres of fresh water. Good pack size for caravans, campervans and boats with smaller fresh water tanks. BauA reg. no.: N-94607



Biozid

300/981 13.95

Hose Reel Aquafil

The hose reel Aquafil is compact, light and easy to transport. Ideal for camping, garden, leisure and much more. The water jet can be adjusted at the spray nozzle.

Scope of delivery: 10 m food-safe 3/8" PVC hose, 2 quick connectors, stable plastic frame, spray nozzle. Dimensions (W x H x D): 155 x 275 x 135 mm; Weight: 940 g

300/731 26.90

16.95

from 47.90



Danger, H318

Fresh Water Tank Cleaner abtycam

Cold water application. Cleans fresh water tanks and pipes, drains and grey water tanks easily in a short time. Unique oxygen- and mineral-based cleaner. Removes odours and dirt. Particularly suitable for water tanks in caravans, motorhomes and boats. Biodegradable. No rinsing.

0.5 kg 33.90/kg 300/013 16.95



Warning, Biocide, Danger, H302, H314, H319, H410, H412

Complete Set Hygiene-Trio

The hygiene trio is an all-in-one water hygiene pack for the entire season. It contains the disinfectant cleaner DEXDA® Clean, the Kxpress descaler and the original Silvertex to automatically conserve water.

BauA (Federal Institute for Occupational Safety and Health) regulation no.: N-86607 / N-108213

Tank capacity	Item no.	Price
60 l	300/946	47.90
100 l	300/420	59.90
160 l	300/947	74.90



9.95



Completely black



Solar Shower

Free warm water thanks to eco-friendly solar power. Even on cloudy days, the water in the 20-litre bag heats up to 40 °C. The newly developed version is black and blank on the back, which guarantees superfast heating. This prevents the proliferation of algae as no light can penetrate. Can be used horizontally or hanging up. Two valves, one on the bag for safe transportation, the other one on the shower head for a convenient handling. Phthalate-free.

300/654 9.95



89.95

NEW

Portable Shower Battery Plus

Collapsible water bucket (17 l) including lid, ideal for the beach, camping and garden. Thanks to the rechargeable battery (Li 1500 mAh), it can be used in many ways without a power connection.

Scope of delivery: expandable water hose (max. 6 m), adjustable spray (7 spray modes) with pistol grip, USB charging cable with indicator. Two transport handles, internal sieve for coarse dirt. Space-saving and easy to clean. Battery can be changed by qualified personnel. Charging time: max. 8 hours (to 100 % with supplied cable). Output: 8 l/min, max. 20 min working time, working pressure: 6 bar.



300/660 89.95



34.95

NEW

Folding Watering Can Flatboy®

The 10 litre folding watering can Flatboy® is the ideal solution for anyone who does not have space for a bulky watering can. With its unique folding technology, the folding can fits easily into the glove compartment when not in use. With two openings for optimum filling and a ventilated spout for perfect emptying, the Flatboy® offers maximum functionality. Its high-quality material is made of plasticiser-free plastics, is BPA-free and food-safe.

300/264 34.95



Trelino® Composting Toilet

Trelino® declares war on chemical toilets!

Trelino® composting toilets are made in Germany and allow you to travel more freely, more sustainably and without using as many resources. The Trelino® composting toilet needs neither water nor chemical additives. This eliminates the need to plan a route along waste disposal stations and gives you more flexibility in your choice of destinations. The clean and odourless separation of liquid and solid waste protects the environment. No matter whether you want a toilet for your tent, van, motorhome, summer house, boat or holiday home, Trelino® will fit anywhere you cannot use conventional toilets.



Composting Toilet Trelino® Evo

The Trelino® Evo is extremely light and can be stowed anywhere. Particularly convenient: the automatic soft-close mechanism and the ergonomic seat. Without water or chemicals, the Trelino® Evo offers the freedom of being independent of waste disposal stations when travelling. Suitable for tents, vans, motorhomes, garden sheds or boats.

Scope of delivery:

- Body
- Attached lid with automatic soft-close mechanism
- Toilet seat
- Separation insert
- Urine canister with lid
- Lid with membrane closure
- Solid waste container

Delivery without fan (301/264).

Size: S

The urine canister has a volume of 4.5 l and the solid waste container has a volume of 6.5 l.
Dimensions: 33x29.6x39; Weight: 3.9 kg
white **301/265 299.00**
anthracite **301/268 319.00**

Size: M

The urine canister has a volume of 5 l and the solid waste container has a volume of 8 l.
Dimensions: 33x36x39; Weight: 4.3 kg
white **301/266 399.00**
anthracite **301/269 419.00**

Size: L

Both the urine canister and the solids container have a volume of 10 l.
Dimensions: 33x43x39; Weight: 4.9 kg
white **301/267 499.00**
anthracite **301/270 529.00**

✓ Available in two colours



from 299.00



+ Accessories

Fan Set

For Trelino® composting toilets from size M onwards. Ensures a higher air exchange, the solids dry faster and no odours develop.

301/264 129.00



29.95

Scent Blocker 20 L

Perfect for composting toilets. Dries out solids and reduces odour formation. Sufficient for 40 trips to the toilet. With effective microorganisms. **301/482 29.95**

6.40



Faeces Bag

Recycling bag with 18 l capacity suitable for all Trelino® composting toilets and solid waste containers up to 15 litres. Per roll: 10 bags (52 x 61 cm). **301/291 6.40**

NEW

✓ microbiological

NEW

20.95

Special Cleaner Holy Shine

Specially for composting toilets. Cleans gently, sustainably and effectively based on microbiological enzymes.

500 ml 41.90/1 **301/292 20.95**



64.95



✓ height-adjustable

NEW

HABA

happy campers

Folding Toilet Torgano

The Torgano folding camping toilet made of sturdy plastic is easy to set up and is height-adjustable thanks to its design. The anti-slip stickers on the underside of the toilet ensure that it does not fall over. The folding toilet is easy to store and transport thanks to its compact pack size. Multifunctional use as a toilet, stool, waste bin or storage box. Incl. 10 toilet bags. Holds up to 150 kg. Weight: 2 kg **301/465 64.95**

2.95



Toilet Bag Torgano

Toilet bag for the folding toilet Torgano; 10 bags on a roll. **301/466 2.95**

Sanitary Additive Solbio

Solbio Original is one of the world's best biological sanitary fluids for mobile toilets. The multifunctional formula is powerful, safe and contains pure and fresh aromas.

- Without chemicals
- Powerful
- Economical
- Can be emptied anywhere

800 ml 24.94/l **301/986 NEW 19.95**
 1600 ml 17.47/l **301/976 27.95**
 3000 ml 16.65/l **301/990 NEW 49.95**



from 19.95

without chemicals

Toilet Additive wc mobil

With its highly effective formula of enzymes and natural microorganisms, the microbiological toilet additive awiwa wc mobil breaks down faeces and toilet paper, ensuring splash-free emptying of the waste tank: no clumps, no clogging and no smell. Unpleasant odours are removed instead of covered. Hygienically clean and free of chemicals for environmentally friendly disposal. The tank content can be flushed down the toilet. Suitable for all portable toilets in motorhomes, caravans or boats. Highly economical: 1 l is enough for 20 applications.



awiwa

Magnetic Knob for Service Door 3

Magnetic knob to keep the door open while you are removing the waste tank. Ideal for vehicles with side walls made from steel (e.g. vans). The knob is covered with a soft rubber layer to prevent scratches. Only for service door model 3.

301/229 11.95



Powerpods Bio

- 1 dose (24.5 ml) is effective for up to 4 days
- 1 pack = 20 pods = 80 days of using the waste tank without worries
- Also suitable for septic tanks
- Innovative microorganism technology
- Convenient pre-dosed pod for maximum ease of use
- Always the right dosage
- Excellent odour control
- Liquefies faeces for easier tank emptying

20 pieces 1.50/piece **301/653 29.95**

Toilet Paper Aqua Soft

The toilet paper by Thetford dissolves very quickly and was developed especially for portable and cassette toilets.

- Prevents clogging when emptying
- Makes emptying the waste tank easier
- Prevents mechanical problems and defects
- Pleasantly soft
- 4 rolls (250 sheets), 2-ply

301/970 4.95



THETFORD



4.95

20 pods | 80 days

29.95



Warning, H319, H412, EUH208

from 89.00



Porta Potti

If you are looking for a comfortable, convenient and durable portable toilet that does not require connection to a drain or water supply system, Thetford has the perfect solution for you: the Porta Potti.

- Light, high-quality plastic
- Vent button for splash-free emptying
- Tried and tested design
- User-friendly sliding handle
- Improved carrying handle for the waste tank
- Improved sitting comfort

Porta Potti



Type	Dimensions (W x H x D)	Seat height:	Flushing system	Level indicator for waste tanks	Capacity of the waste tank	Capacity of the fresh water tank	Weight	Item no.	Price
PP 145	383 x 330 x 427 mm	324 mm	bellow pump	no	12 l	15 l	3.6 kg	301/515	89.00
PP 335	342 x 313 x 382 mm	308 mm	piston pump	yes	10 l	10 l	3.3 kg	301/517	149.00



Gas Fill Level Indicator W8 Gascontrol 2.0

The electronic device W8 Gascontrol 2.0 measures the fill level of gas cylinders and transmits it via Bluetooth to smartphones or tablets with Android or iOS technology. Due to its very low installation height, the Gascontrol W8 can be used in the gas cylinder box of most recreational vehicles.

Features: for ø 30 cm gas cylinders (steel, aluminium, plastic, fibreglass); compatible with Android and iOS systems: the app can be used to operate two scales; operation with batteries (not rechargeable); housing made of impact-resistant plastic; delivery without batteries and mobile device. Dimensions (W x H x D): 292 x 31 x 292 mm; Weight: 800 g

320/384 149.90



149.90



Froli

MADE IN GERMANY



42.95

Gas Cylinder Holder

Holder for securely fixing the gas cylinder to the floor or to a base plate. Additional fastening to the side is not necessary. The gas cylinder is placed on the holder for 5 kg or 11 kg cylinders and fastened to the neck of the cylinder with a fastening strap.

Dimensions (L x W): 305 x 305 mm

320/389 42.95



from 75.00

Gas Cylinder Plastic

The plastic gas cylinder is sustainable and rust-proof and has a modern look as well as improved safety features. The light property cylinder is equipped with ergonomic handles. The fill level is visible and the valve is protected by a collar. Empty weight 5.3 kg. The cylinder is delivered empty. Dimensions (H x ø): 57.1 x 30.5 cm; Weight: 5.3 kg

320/356 99.90



99.90

CAMPINGGAZ

Butane Gas Cylinder, Filled

The larger gas cylinders filled with butane gas are made for longer, intensive or regular use. All Campinggaz® gas cylinders are equipped with a safety valve and can be removed from the unit at any time. Bring your empty gas cylinder to an exchange dealer in Europe. You will get a full, carefully checked and properly filled cylinder of the same size for the price of a fill.

	Content	Item no.	Price
R 904	1,85 kg	320/354	85.00
R 907	2,8 kg	320/355	97.50



85.00

Attention, H220



97.50

Gas Cylinder

With valve and protective cap, officially certified, empty; with protective cladding. Filled with propane/butane.

5 kg 320/350 75.00
11 kg 320/351 99.90

Aluminium Gas Cylinder

Overloaded drawbar boxes and rusty bottles are outdated. Compared to common gas cylinders, you can save up to 5 kg in weight. Alugas cylinders do not rust, which means that your gas lines cannot be blocked by rust particles. Internationally and TÜV-approved. Safety valve and valve cap included. The cylinder is empty.

- Lighter than conventional gas cylinders
- TÜV approval strictly according to EN standard
- No rust, no blocked pipes
- High-quality alloy, timeless design, fine surface
- Durable, energy-saving, recyclable

6 kg 320/366 159.00
11 kg 320/352 165.00

from 159.00



28.90



Gas Cylinder Valve

Type: CGV

For connection to butane and propane cylinders up to 5 kg filling weight. With operating valve (open – close). Safety relief valve – response pressure 14 bar. Connection: GAZ x AG KLF

310/827 28.90

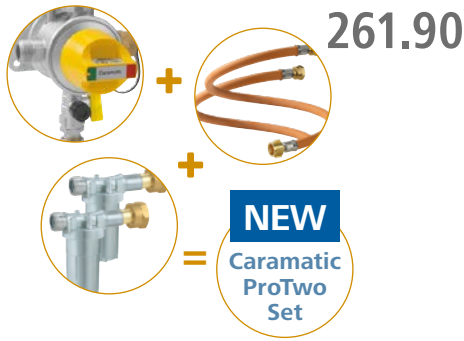

Caramatic ProTwo Set

Consists of: 2 x Caramatic ConnectBasic (length: 450 mm), 2 x Caramatic ConnectClean 2.0 with bracket, automatic switch valve, low-pressure regulator with PRV safety relief valve, control knob, operating and reserve indicator, check valve, test device and wall bracket. max. pressure PS 16 bar

30 mbar	311/181	261.90
50 mbar	311/184	261.90

179.90



Safety Gas Pressure Regulating System Caramatic SafeDrive

Safety gas pressure regulating system for operating one-cylinder systems in motorhomes and caravans while travelling, for direct connection to the gas cylinder. Consists of: mechanical crash sensor with new pendulum solution, low pressure regulator with overpressure safety device S2SR (ÜDS), hose line and regulator brackets. Connection: G.12 (KLF) x RVS 10/8

30 mbar	311/210	179.90
50 mbar	311/211	179.90

386.50



Safety Gas Pressure Regulating System Caramatic SafeDrive Plus

Automatic safety gas pressure switch system for operating two-cylinder systems in motorhomes and caravans while travelling, for direct connection to the gas cylinders. Consists of: central and switchover regulator with mechanical crash sensor with new pendulum solution and manometer, hose lines and regulator brackets. Connection: G.12 (KLF) x RVS 10/8

30 mbar	311/213	386.50
50 mbar	311/214	386.50

202.90



30 mbar



Caramatic DriveOne Set

Safety gas pressure control system for operating one-cylinder systems in caravans and motorhomes while driving.

Consists of:

- Low pressure regulator with excess pressure protection S2SR (ÜDS)
- Mechanical crash sensor with new pendulum solution
- Test device and wall bracket
- Caramatic ConnectClean with angle bracket
- Caramatic ConnectDrive

Advantages and features: Heating while driving thanks to integrated mechanical crash sensor with a new pendulum solution, which shuts off the gas flow in the event of an accident with a deceleration of $3.5 \text{ g} \pm 0.5 \text{ g}$ acting directly on the trigger element. This corresponds to an impact speed of approx. 15 to 20 km/h on a fixed obstacle with an average vehicle weight.

vertical	311/162	202.90
horizontal	311/163	202.90

Information

Please note: Meets the requirements of DGUV regulation 79 (German Social Accident Insurance – previously BGV D 34) and is suitable for use in commercially used caravans and motorhomes!

179.90



Safety Gas Pressure Regulating System Caramatic SafeDrive

Safety gas pressure regulating system for operating one-cylinder systems in motorhomes and caravans while travelling, for direct connection to the gas cylinder. Consists of: mechanical crash sensor with new pendulum solution, low pressure regulator with overpressure safety device S2SR (ÜDS), hose line and regulator brackets. Connection: G.2 Shell-F x RVS 10/8, Operating pressure 30 mbar

311/212	179.90
----------------	---------------

346.50

GOK



30 mbar



Caramatic DriveTwo Set

Safety gas pressure control system with automatic switch valve for operating two-cylinder systems in caravans and motorhomes while driving. For connection to gas cylinders via high-pressure hose line and for pressure control to the nominal pressure of the gas device.

Consists of:

- Automatic switch valve
- Low pressure regulator with safety relief valve PRV
- Mechanical crash sensor with new pendulum solution
- Control knob
- Operating and reserve indicator
- Check valve
- Test device and wall bracket
- 2 x Caramatic ConnectClean with angle bracket
- 2 x Caramatic ConnectDrive

Advantages and features: Heating while driving thanks to integrated mechanical crash sensor with a new pendulum solution, which shuts off the gas flow in the event of an accident with a deceleration of $3.5 \text{ g} \pm 0.5 \text{ g}$ acting directly on the trigger element. This corresponds to an impact speed of approx. 15 to 20 km/h on a fixed obstacle with an average vehicle weight.

vertical	311/164	346.50
horizontal	311/165	346.50

386.50



Safety Gas Pressure Regulating System Caramatic SafeDrive Plus

Automatic safety gas pressure switch system for operating two-cylinder systems in motorhomes and caravans while travelling, for direct connection to the gas cylinders. Consists of: central and switchover regulator with mechanical crash sensor with new pendulum solution and manometer, hose lines and regulator brackets. Connection: G.2 Shell-F x RVS 10/8, Operating pressure 30 mbar

311/215	386.50
----------------	---------------



GOK

Accessoires

Caramatic Two-Control



Remote Display and Regulator Heater

Caramatic TwoControl with transmitter for remote display and regulator heater Eis-Ex. **311/150 163.90**

Regulator Heater

Caramatic TwoControl with regulator heater Eis-Ex. **311/151 122.90**

Regulator Heater Eis-Ex

311/153 48.90

Transmitter Remote Display

311/152 44.50

Medium-Pressure Hose Line



For VW vans. For connecting fittings, consumer appliances and pipes. DVGW-tested. G 1/4 left-hand thread union nut x pipe socket. **Rubber** hose line with textile insert. Hose dimensions 6.3 x 3.5 mm. **Cold-resistant down to -30 °C.** Length: 300 mm **310/717 10.50**



For connecting fittings, consumption devices and pipes. DVGW-tested. Rubber hose with textile inlay. Cold-resistant down to -30 °C. Hose dimensions 6.3 x 3.5 mm.

Length	Item no.	Price
400 mm	310/763	9.50
450 mm	310/756	10.75
750 mm	310/757	11.50
1000 mm	310/751	11.75
1500 mm	310/752	13.50
2000 mm	310/753	16.50

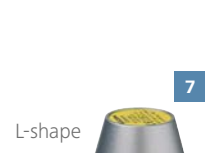

1 | Filter Cartridge 2.0

Replacement cartridge for the gas filter Caramatic ConnectClean. **311/172 9.90**

2 | Mounting Bracket

For attaching the gas filter Caramatic ConnectClean to the wall. **311/126 5.95**

3 | Lock Nut

311/118 8.90

4 | Connection Set

311/117 29.50

5 | Connecting Piece

For connecting a low pressure regulator type EN61, EN61-DS or EN71 with small cylinder connection to the Caramatic SwitchTwo. **311/116 16.90**

6 | Elbow Piece 90°

For installation when space is limited. AG M20 x 1.5 x M20 x 1.5 swivel nut. **310/796 18.90**



without pressure gauge

8 | Low Pressure Regulator 1.2 kg/h

Type: EN71
Low pressure regulator for direct connection to the liquid gas cylinder with safety relief valve PRV.

Operating pressure: 30 mbar

max. pressure PS 16 bar
straight **310/712 29.50**

Low Pressure Regulator 1.5 kg/h

Type: EN61-DS
Low pressure regulator with overpressure safety device S2SR (ÜDS). For direct connection to the liquid gas cylinder.

Connection: KLF x G 1/4 LH-KN

Operating pressure: 30 mbar

max. pressure PS 16 bar
without pressure gauge **310/714 49.50**
with pressure gauge **310/713 75.50**

7 | Low Pressure Regulator 0.8 kg/h

Type: EN61
The regulators are ideal for gas boxes and small camping vehicles where space is limited. In the VW camper vans by Westfalia, the regulator with the L-shape was installed until 2005. For vehicles built since 2006, the regulator with the U-shape is used. Nominal flow: 0.8 kg/h.

U-shape: Thanks to the U-shape, the transition to the hose is located at the base of the gas cylinder and therefore does not extend beyond the gas cylinder.

L-shape: Thanks to the L-shape (90° angle), the hose is guided downwards and needs less space than conventional regulators.

Operating pressure: 30 mbar

max. pressure PS 16 bar

straight **310/711 25.50**
U-shape **310/709 47.50**
L-shape **310/710 45.50**

Senso4s PLUS

Advantages and features:

- Easy installation: switch on Bluetooth, place the gas cylinder on the adjustable feet of the Senso4s fill level indicator, measure and read the values in the app
- For all common steel, aluminium and plastic gas cylinders with a filling weight of up to 16 kg
- Connection via Bluetooth between Senso4s and your smartphone/tablet
- Menu language of the app: German, English, French, Italian, Spanish or Slovenian
- Records the parameters filling and tare weight of the respective gas cylinder

- Management of several gas cylinders in different sizes
- From the second measurement, the app already calculates a long-term forecast of the gas consumption
- If a Bluetooth connection is established, the Senso4s PLUS sends the measurement data to the app at 15-minute intervals
- Battery level indicator of the level meter in the app
- May also be used e.g. in the gas cylinder box of recreational vehicles thanks to ATEX certification. **311/160 109.00**

109.00

GOK



BEST SELLER

✓ Fill Level Indicator for Gas Cylinders



Gas Pressure Regulator with Crash Sensor

The gas pressure regulators by Truma are characterised by their extremely compact and light design. The crash sensor (CS) was optimised: if the sensor is triggered, it is shown by the yellow button. The Truma gas pressure regulator CS can be used whether your motorhome or caravan is parked or in motion.

Reliable: secure operation of gas devices even on the road – thanks to the integrated crash sensor

Comfortable: simply detect the triggered sensor and reset it

Convenient: indicates which bottle is in operation and thus full or empty (DuoControl CS)

Light: low weight

Technical data: type of gas: liquid gas (propane/butane); input pressure: 0.7 – 16 bar (DuoControl CS), 0.3 – 16 bar (MonoControl CS); output pressure: 30 mbar; regulator capacity: 1.5 kg/h; regulator input: external thread M 20 x 1.5 (G.13); regulator output: cutting ring connection 10 mm or 8 mm (H.9).



MonoControl CS

Gas pressure regulator with crash sensor for one gas cylinder, wall or ceiling installation.

Dimensions (W x H x D): 101 x 106 x 102 mm

309/607 139.95



DuoControl CS vertical



DuoControl CS horizontal

from 139.95

DuoControl CS vertical

Gas pressure regulator with crash sensor and switchover system for two gas cylinders, wall installation.

Dimensions (W x H x D): 95 x 184 x 103 mm

309/605 208.95

DuoControl CS horizontal

Gas pressure regulator with crash sensor and switchover system for two gas cylinders, ceiling installation.

Dimensions (W x H x D): 158 x 104 x 116 mm

309/606 208.95



Replace the filter pad every time you change the cylinder.

Safe gas supply even while driving!

Truma does not grant warranty for defect gas pressure regulators which have been used without Truma gas filters and Truma high-pressure hoses!

High-Pressure Hoses

For maximum security on the road and at the campsite, Truma offers high-pressure hoses equipped with hose rupture protection (SBS). They meet all legal requirements for running gas systems while driving but are also suitable for stationary use. If the hose is damaged, the protection is triggered and stops the gas flow.



Length: 450 mm;	Item no.	Price
G.12 (DE, AT, FI, PL)	309/609	52.95
G.7 (GB, IE)	309/611	52.95
G.2 (FR, CH)	309/612	52.95
G.1 (IT, MT, CY, GR, TR)	309/614	52.95
G.10 (SE, NO, IS, PT)	309/615	52.95
G.8 (GB, IE, ES, BE, NL, DK, NO, HR, CZ, SI, SK, HU)	309/616	52.95

Length: 750 mm;	Item no.	Price
G.12 (DE, AT, FI, PL)	309/610	54.95
G.2 (FR, CH)	309/613	54.95
G.8 (GB, IE, ES, BE, NL, DK, NO, HR, CZ, SI, SK, HU)	309/617	54.95



from 57.95

Gas Filter

The Truma gas filter effectively protects your gas system against soiling: oily residues are reliably filtered out and collected in a filter pad. Simply replace the filter pad with a new one each time you change the bottle. The gas filter fits all wall- or ceiling-mounted Truma gas pressure regulators.

- Filters up to 99.9 % of aerosols and protects the gas system and all gas devices.
- Together with the pads, you can use the filter for longer and save money.
- Can be opened quickly and without tools to control and replace the pad.
- Opening is only possible when the gas cylinder is closed.
- Fits into nearly all gas cylinder boxes.
- Quick to retrofit.

Input: exterior thread M20 x 1.5 (G.13)

Output: union nut M20 x 1.5 (H.20)

Dimensions (W x H x D): 81 x 67 x 54 mm;

Weight: 370 g

1 pieces

309/618 57.95

2 pieces

309/619 94.95

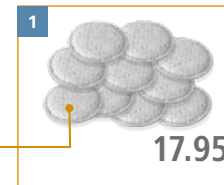

17.95



7.95



18.90



34.95

from 52.95

1 | Filter Pads

Filter pads for gas filters.

Content: 10 pieces

2 | Mounting Bracket for Gas Filter

Mounting bracket for gas filter.

309/620 7.95

3 | Elbow Piece 90°

For installation when space is limited. AG M20 x 1.5 x M20 x 1.5 swivel nut.

310/796 18.90

4 | Extension Kit DuoC

For use with DuoControl (CS) or DuoComfort at a gas cylinder distance of more than 100 cm.

309/830 34.95



✓ get through the winter without any problems



56.95



EisEx

At a temperature of 0 °C, tiny droplets of ice or propane hydrate can form in the regulator due to traces of water in liquid gas. This reduces or stops the gas supply.

The regulator heater EisEx prevents the formation of ice droplets with electrical heating. EisEx ensures trouble-free gas supply even in winter. Cable length: 150 cm **310/794 56.95**



174.95



Remote Gas Switch

Main shutoff valve for the gas supply: 12 V incl. 1.5 m connection cable and control panel. For comfortably turning off the gas supply from inside the vehicle. GS 8 (gas pipe ø 8 mm), GS 10 (gas pipe ø 10 mm).

GS 8 **310/058 174.95**
GS 10 **310/099 174.95**



174.95



Remote Indicator DuoC with EisEx

DuoC, the remote display for the DuoControl CS from 2019 on, indicates inside the vehicle which gas cylinder is in operation. The EisEx prevents the system from freezing at low temperatures.

Scope of delivery: control panel, cable harness 6 m, transmitter 1.5 m, integrated EisEx **309/608 174.95**

Gas Fill Level Indicator LevelControl

i Measurement with ultrasound

The Truma LevelControl uses ultrasound to measure how much gas is in the cylinder and sends the data via Bluetooth to a smartphone or tablet.

The Truma LevelControl app provides a convenient overview of the gas level and displays it as a percentage and the amount of gas in kilograms. The Truma LevelControl is suitable for all standard European steel and aluminium cylinders (5 kg to 33 kg). An additional clamping plate is required for aluminium cylinders!

Advantages:

- **Precise:** precisely measures the cylinder's fill level in per cent and kg.
- **Comfortable:** easy to install and use with the Truma LevelControl app
- **Convenient:** simply use the integrated magnets to attach it to the bottom of the cylinder and remove it when changing cylinders
- **Universal:** works with all common European steel and aluminium gas cylinders (Logo EIA 2019)

Scope of delivery: Truma LevelControl, 3 feet, 2 batteries Micro 1.5 V, magnetic foil LevelControl for the gas cylinder, installation and operating instructions

Technical data: Gas type: propane/butane, power supply: 3 V / 2 x 1.5 V batteries (alkaline, LR03, AAA), current consumption: max. 70 mA, quiescent current consumption: 0.001 mA, operating temperature: -20 °C to +50 °C, Bluetooth: Class 2, weight (including battery): 120 g **320/393 178.95**



178.95

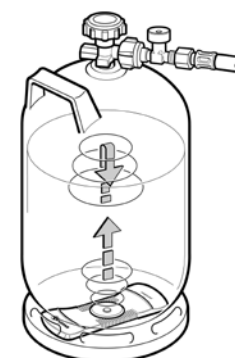

+ Accessories

23.95



Clamping Plate

Clamping plate for attaching the LevelControl to aluminium cylinders, as they are not magnetic. Dimensions (W x H x D): 22.9 x 6.3 x 2.6 cm; Weight: 150 g **320/395 23.95**

Gas Fill Level Indicator Truma LevelCheck

Truma LevelCheck is a mobile fill level indicator for all (propane/butane – LPG) steel or aluminium gas cylinders with a diameter of 200 to 350 mm. The device uses ultrasound to recognise whether there is liquid gas in the cylinder at the measuring point and indicates this. Not for fillable tank gas cylinders.

- LED display: green/gas, red/no gas
- Reliable measurement via ultrasound
- With integrated LED flashlight

Technical data: Power supply: E-block 9 V; measurement in temperature range: from -15 °C to +40 °C; weight: (including battery): approx. 100 g

Scope of delivery: Truma LevelCheck, battery 9 V **320/373 84.95**

i With the Truma LevelCheck, you always know if there is enough gas left in the cylinder when camping!

84.95





Mobile Heater in a Heat Box

The mobile parking heater Autoterm 2D by Pundmann in 3 variations. Be it in a roof tent, in small quarters, in a tent or generally when camping, it is the ideal companion for outdoor enthusiasts. Due to its small dimensions and the small capacity of 40 litres, the heater can easily be stowed in the boot and is therefore always with you. Two handles make it easy to carry the heater from one place to another. Incl. remote control and Anderson plug for charging other devices. Ideal for rooms up to 20 m².

Technical data: Heat output: 0.8 to 2 kW; consumption: 0.10 l/h to 0.24 l/h.

mobile parking heater, tank only

Runtime: 41 h – 100 h

Dimensions (WxHxD): 533x300x253 mm

Weight: 11 kg **311/040 1,149.00**

mobile parking heater, tank and AGM battery

Runtime: 12 h – 50 h

Charging time: 8 h

Dimensions (WxHxD): 533x300x253 mm

Weight: 20 kg **311/041 1,350.00**

mobile parking heater, tank and LiFePO battery

Runtime: 20 h – 50 h

Charging time: 4 h

Dimensions (WxHxD): 533x300x533 mm

Weight: 17 kg **311/042 1,999.00**

NEW



from 1,149.00



Warm Air Hose Set PUNDMANN

The warm air hose set for mobile parking heaters can be used to transfer warm air into the tent or into small rooms. The set consists of a carry bag with 4 m of weather-resistant neoprene hose, clamps for attaching the hose to the tent and clamps for attaching the hose to the heater.

311/043 170.00



170.00



Mobile Boiler PUNDMANN

Discover the mobile solution for hot water from PUNDMANN. With a capacity of 6 litres, this appliance offers a simple and uncomplicated way to heat water when travelling. Thanks to the 200 W heating element, water is heated efficiently without the need for permanent installation. Made from high-quality stainless steel in accordance with drinking water standards, it guarantees maximum safety and quality when travelling. The mobile boiler has a capacity of 6 litres of cold water and up to 20 litres of hot water. The heating time is approx. 60 minutes.

Technical data:

- Voltage: 12 V/200 W
- Pressure: 2.3 bar
- Heating time: approx. 60 minutes
- Connection: 1/2 inch
- Safety valve: 3 bar

w/o warm air connection **311/062 899.00**
with warm air connection **311/063 849.00**



NEW

849.00

899.00



✓ efficient heating thanks to the 200 W heating element



**NEW****79.95****Camping Stove BlueCraft**

The gas stove is equipped with two burners with an output of 2.2 kW each. The sturdy enamelled pan supports ensure that the pots and pans are held securely. Ideal for outdoor cooking!

Thanks to the integrated **flame failure device**, the gas supply is interrupted as soon as the flame goes out, e.g. due to a draught. A safety feature that should not be missing on gas-powered appliances. **310/695 79.95**

149.00**Information**

Get 2 gas cartridges for free! More information: www.campinggaz.com

Camping Kitchen™ 2 Grill & Go Campinggaz

The Camping Kitchen™ 2 Grill & Go CV is a compact and versatile cooking and grilling companion. The 2-burner hob with removable grill grate and plancha plate gives you the flexibility you need to cook or grill a variety of dishes. Be it on an outdoor adventure or with family and friends in the comfort of your own home, the Camping Kitchen™ 2 Grill & Go CV will not disappoint. Nominal capacity: 4000 W; Gas consumption: 290 g/h; Dimensions (W x H x D): 49 x 35 x 35 cm; Pack size: 49 x 31.5 x 10 cm; Weight: 5.5 kg cartridge **320/987 149.00**

**64.95****CAMPINGGAZ**

Attention, H220

**12.50****5.50****8.50****Camping Stove Camp'Bistro™ DLX Stopgaz with ignition fuse**

This light yet powerful table stove is ideal for picnics and day trips. Burning time: min. 1 hour 15 minutes. With piezo ignition and stainless steel insert, for Campinggaz® CP250 valve cartridge, incl. carrying case.

Operating pressure: cartridge; Nominal capacity: 2200 W; Gas consumption: 160 g/h; Dimensions (W x H x D): 37 x 28.9 x 12.5 cm; Pack size: 38.7 x 31.7 x 12.95 cm; Weight: 1.87 kg

310/012 64.95**Valve Cartridge with Clic Closure**

These valve cartridges have self-sealing valves that are very safe and have the advantage of being resealable – they can be connected to and disconnected from the device even when they are not yet empty. Therefore, they are ideal for regular, modern use.

CV 300 Plus

Valve cartridge with 240 g gas mixture 80/20 butane/propane.

240 g 35.42/kg **320/988 8.50**

CV 470 Plus

Valve cartridge with 450 g gas mixture 80/20 butane/propane.

450 g 27.78/kg **320/989 12.50**

CP 250

Valve cartridge with isobutane gas. For use in Campinggaz® appliances from the Bistro® and Festivo® range.

220 g 25.00/kg **310/594 5.50**

Attention, H220

**3.20****Pierceable Cartridge C206 GLS**

Pierceable cartridge with butane/propane mixture in a ratio of 80/20. For supplying Campinggaz® devices of series 206. With Gas-Lock-System (GLS) in compliance with the European standard EN 417:2012: If the cartridge is accidentally removed from the appliance, the gas flow is almost stopped. A pierceable cartridge may only be removed when completely empty.

190 g 16.84/kg **320/390 3.20**



Perfect for smaller camping vehicles

from 79.95**Camping Kitchen™ 2 Campinggaz**

The Camping Kitchen™ 2 is the perfect stove for family outings. It is a lightweight and easy to transport stove with two burners. The compact design with carrying handles enables space-saving storage in the car or motorhome. The pan supports made of enamelled steel also serve as wind protection and are dishwasher-safe. The stove offers space for two pans (ø 24 cm) and is supplied with a regulator (only with cartridge) and a hose.

Nominal capacity: 4000 W; Gas consumption: 290 g/h; Dimensions (W x H x D): 49 x 33 x 45 cm; Pack size: 49 x 31.5 x 10 cm; Weight: 3.1 kg 50 mbar **320/985 79.95** cartridge **320/986 99.95**



Party Grill™

Multi-functional, compact stove that can be transformed into a barbecue within seconds. All devices from the Party Grill™ series are a multi-functional alternative to traditional stoves and compact barbecues. They are easy to clean and available in three different sizes and for different energy sources. Easy to transport, with pan support, reversible grill and contact grill plate and grill lid. The tray underneath the Party Grill™ 600 R can be used to store utensils and provides more stability. The grill surface is non-stick coated and the heat supply is very finely adjustable via a rotary knob. Grease and meat juices drip into the grease pan, reducing smoke and spurting flames. The convenient legs can be easily attached and stowed away in the barbecue for transport or storage (delivery does not include gas cylinder).

✓ for all gas cylinders

400 R

With piezo ignition. Scope of delivery: lid with wok option, pan support, reversible grill and contact grill plate and grill grate. Incl. transport bag and hose.

Without ignition fuse. Operating pressure: 50 mbar; Nominal capacity: 2 kW; Gas consumption: 145 g/h; Dimensions (HxØ): 42 x 36 cm; Pack size: 36 x 35.5 x 27 cm; Weight: 4.92 kg **310/407 145.00**



✓ can be stored compactly

400 CV

With piezo ignition and Easy Clic™ connection for valve cartridges CV 300 Plus and CV 470 Plus. Scope of delivery: lid with wok option, pan support, reversible grill and contact grill plate and grill grate. Incl. transport bag.

Without ignition fuse. Operating pressure: cartridge; Nominal capacity: 2 kW; Gas consumption: 145 g/h; Dimensions (HxØ): 42 x 36 cm; Pack size: 36 x 35.5 x 27 cm; Weight: 4.92 kg **310/409 145.00**



145.00

Gas Regulator Hose Line Set

For connection to gas cylinders, for the operation of gas appliances. Consists of: low-pressure regulator, medium-pressure hose 1500 mm (rubber with textile insert; cold-resistant to -30 °C; hose dimensions 6.3 x 3.5 mm), plug-in coupling SKU-QR, plug-in nipples STN and MiniTool. max. pressure PS 16 bar

w/o manometer 50 mbar **350/450 49.95**

with manometer 50 mbar **350/451 96.95**



GOK

from 49.95

NEW

Valve Cartridge

NEW

2.95

The Baygas butane gas valve cartridge is ideal as a refill for appliances with an MSF-1A connection system. You can easily use the cartridge in gas burners, camping stoves, weed burners and much more. It is placed on the counter-part by turning.



227 g 13.00/kg **320/113 2.95**



Attention, H220, H280, H281, H336

Valve Cartridge

NEW

7.95

Baygas butane gas valve cartridge 500 g with screw cap. Compatible with all commercially available gas stoves, gas barbecues and gas burners with screw cap, EBETAM-tested, EN417.



500 g 15.90/kg **320/112 7.95**

Lid/pot 30
ø 28 cm



Grill grate 30
ø 26 cm



Grill grid 30
ø 28 cm



Grease pan



Pot stand

Burner unit with piezo ignition

Folding legs



159.95

CADAC
DOMETIC

Safari Chef 30

This portable and versatile gas barbecue weighs less than 4 kg and includes four interchangeable cooking and grilling surfaces: pan stand, Green-Grill ceramic-coated grill grate and grill plate and a lid that can be used as a pot.

The complete barbecue is stored in a convenient carry bag (included in delivery).

The Safari Chef 30 is available in a high or a low pressure version. The Safari Chef HP (high pressure) works with a 500 g threaded cartridge (not included), which is screwed directly into the device, while the Safari Chef LP (low pressure) can be connected to a normal gas cylinder (hose and pressure reducer not included). The Safari Chef 30 is ideal for camping, climbing or fishing.

Accessories (optional): paella pan, pizza stone

Without ignition fuse.

Ignition system: Piezo ignition; Nominal capacity: 1,8 kW; Dimensions (W x H x D): 38.8 x 22 x 22 cm; Pack size: 33 x 33 x 24 cm; Weight: 3.6 kg

Safari Chef 30 HP

Gas consumption: 132 g/h cartridge **350/287 159.95**

Safari Chef 30 LP

Gas consumption: 130 g/h 50 mbar **350/286 159.95**





Developed for
Recreational
Vehicles



Lightweight



Small Surface
High
Performance



Small
Construction
Height

BÜTTNER
→DOMETIC

Solar Panel MT Flat Light Q



The solar panel by Büttner Elektronik was developed for pop-tops and high roofs of camper vans, vans, campers or as a walk-on version for your motorhome's roof. The panel combines high quality and maximum solar capacity. Thanks to its square design, it is possible to operate consumers such as compressor fridges and/or inverters self-sufficiently despite limited space and battery capacity. When adhering the panel to high roofs, it is possible to lead the connection cable downwards inside the panel. However, an ultra-flat roof cable routing is also included in delivery. For this 42-cell high-performance panel, an MPPT solar controller is mandatory.

All-In-One Solar System MT Flat Light

All-in-one solar system with the established MT Flat Light installation components: ultra-flat solar panel(s) with crystalline cell technology; MPPT solar controller with Bluetooth and temperature sensor; cable routing to the roof; adhesion kit; cable kit with EBL, mounting material, mounting instructions.

MT 170 FLQ

Number of panels: 1
Nominal capacity: 170 Wp;
Daily output: 750 Wh;
Dimensions (LxW): 980x980 mm;
Weight: 7.8 kg

323/422 1,345.00

NEW

BEST
SELLER

MADE IN
GERMANY



Danger,
H225,
H319,
H336,
H412,
EUH066,
EUH208,
EUH210,
EUH211



from 1,345.00

✓ Square – compact – powerful

MT 340-2 FLQ

Number of panels: 2
Nominal capacity: 340 Wp, Daily output:
1500 Wh; Dimensions (LxW): 980x980 mm;
Weight: 9.8 kg

323/425 2,499.00



Developed for
Recreational
Vehicles



Lightweight



Suitable for
Boats



Small
Construction
Height

BÜTTNER
→DOMETIC

Solar Panel MT Travel Line

Travel Line solar panels – the mobile solution!

Mobile solution for solar panels for recreational vehicles in a high-quality design – made in Germany. The panels are not only light and folding, but also very durable, even under the most adverse conditions. Powerful solar cells ensure maximum solar power on a small surface area – ideally protected by a newly developed, highly robust, light back material and sewn into the best tarpaulin fabric currently available in the marine sector.

Another novelty are the industrial magnets integrated into the fabric. They provide a strong hold, e.g. on the van roof or on the side of the vehicle, while textile material protects the coated support surface.

Thanks to the integrated eyelets, the solar panels can also be mounted individually, e.g. with

pegs at the sunny spot or hanging in a tree, while the vehicle itself is standing in the shade, which is possible because of a 10 m connection cable. Furthermore, the mobile solar controller (battery type adjustable) included with every panel ensures the correct charging voltage. Simply unfold the solar panels, plug in the charge controller and connect it to the RV battery via the plug connection – done!

Travel Line solar panels include: folding panel with crystalline cell technology, 10 m connection cable with universal plug, integrated eyelets and industrial magnets + Travel Line solar controller.

MT SM 65 TL

Nominal capacity: 65 Wp; Daily output: 260 Wh;
Dimensions (LxW): 1256x432 mm; Weight:
3.2 kg

322/829 865.00

MADE IN
GERMANY



from 865.00



MT SM 65 TL

MT SM 120 TL

MT SM 120 TL

Nominal capacity: 120 Wp; Daily output:
480 Wh; Dimensions (LxW): 1106x850 mm;
Weight: 5.7 kg

322/830 1,295.00

Light&Flat SOLAR

✓ Extremely flat, light
and compact!



439.00

Solar Panel Light & Flat

The panel is extremely flat, light and compact and can be glued directly onto the vehicle roof. The high-performance cells are protected by a weather-resistant plastic film. The connection cable (5 m) is firmly cast onto the panel so that no moisture can get in. The included flat roof duct is resistant to pressurised water and can be glued on.



More?
Online!

SM LFS 120

Nominal capacity: 120 Wp; Daily
output: 480 Wh; Dimen-
sions (LxW): 1090x670 mm;
Weight: 2.5 kg

322/696 439.00

✓ Accessories

BEST
SELLER



BÜTTNER
→DOMETIC

20.95

Gap Filler Set

Due to the longitudinally profiled roof surface of the Fiat Ducato van, it is not easy to glue on solar mounting profiles and Flat Light solar panels. This is why special "gap fillers" were developed. They are glued into the recesses with Sikaflex (included with every all-in-one system). The bracket or the Flat Light solar panel is then glued onto the continuous surface.

Gap filler set consists of 2 specially pretreated aluminium sheets. The number of sheets required depends on the panels' width and positioning. Weight: 160 g

322/561 20.95

Campere Solar Panel – Customised Solar Power

The monocrystalline **campere** solar panels by LILIE with tested first-choice cells (78 x 39 mm) allow you to make optimum use of the available free space.

A variety of superstructures make the roof area of your motorhome a challenge for the installation of a solar system.

If a solar panel is partially shaded in a conventional series connection, this reduces the current yield of all other panels. The innovative parallel connection of the **campere** SPL25 and SPL105 solar panels by LILIE prevents this effect. As the voltage remains constant when connected in parallel, only the output of the partially shaded panels is reduced. All other panels continue to deliver full power.

In contrast to classic series mounting, **campere** solar panels connected in parallel can also be installed with different amperages. The amperages of all panels are added together to form the total amperage. The solar panels only need to have the same voltage.

campere from 69.00

LILIE
water | light | energy

from 135.00



Solar Charge Controller Series LSR MPPT

Highly developed MPPT (Maximum Power Point Technology) with a tracking efficiency of up to 99.5 % and a peak efficiency of 98 %. Automatic voltage detection 12 V or 24 V. Intelligent charge control for wet, AGM, gel and lithium batteries (programmable). Integrated LCD display with real-time display of charging function, (battery) charge status and discharge current. Nightlight function. Two USB interfaces for charging mobile phones, RS485 interface with Modbus-open architecture. External solar display can also be connected. Protective functions for overcharging, reverse discharge, short circuit, overload and overheating as well as reverse polarity protection.



Single Panel SPL

Type: SPL25

Nominal capacity: 25 Wp
Daily output: 112 Wh
Dimensions (WxHxD):
79x3x19 cm
Weight: 1.45 kg

322/880

PRICE TIP

69.00

Type: SPL105

Nominal capacity: 105 Wp
Daily output: 470 Wh
Dimensions (WxHxD):
119.6x3x54 cm
Weight: 6.9 kg

322/881

189.95

Type: SPL140

Nominal capacity: 140 Wp
Daily output: 630 Wh
Dimensions (LxWxH):
119.6x66.7x3 cm
Weight: 8.1 kg

322/891

219.95



Solar Connection Cable Set

Waterproof MC4-compatible connectors for tool-free assembly and disassembly. Two connections each for plus and minus. This enables parallel connection with polarity protection. Matches the connections of the LILIE solar panels SPL25 and SPL105.

322/886

24.95



Roof Cable Routing

white 322/888 6.20
black 322/889 11.50

Simple expansion of the system possible thanks to plug & play, no complex cable laying necessary

Simple expansion of the solar system on the roof using accessories, can be extended as required

Uncomplicated installation with pre-configured cables and connector sets

Cost-effective expansion option, installation work is minimal for retrofitting

Main catalogue

Adhesive sets can be found in the main catalogue on pages 369 and 570.

Combine panels with different sizes and currents

Solar Cable with Plug

For connecting solar panels and charge controllers, single-core. The special OF LEX insulation is temperature-, UV-, ozone- and weather-resistant. Suitable for SPL25 and SPL105.

Plastic-coated, very flexible, 2 x 6 mm². Fitted with MC4 plugs on both ends.
1 m 322/887 18.90



Plastic-coated, very flexible, 2 x 10 mm², red/black. Fitted with MC4 plugs on one end.
5 m 322/885 44.95



LSR 20M

Nominal capacity: 260 W
Charging current: 20 A
Dimensions (WxHxD):
21.6x5.7x15 cm;
Weight: 900 g

322/882

135.00

LSR 40M

Nominal capacity: 800 W
Charging current: 40 A
Dimensions (WxHxD):
25.7x6.7x18.3 cm;
Weight: 1.6 kg

322/884

195.00



Temperature Sensor

Temperature sensor with 2 m connection cable and mounting hole M8.

322/903

14.95

LCD Battery Computer

Battery computer suitable for all LILIE solar charge controllers.

322/890

89.00



All-In-One Solar System MT Black Line from 599.00 **NEW**

The installation kit includes everything you need to mount a solar system onto your recreational vehicle. Each all-in-one system comes with matching spoiler profiles and a robust, concealed cable routing to the roof. These high-quality PUR plastic components are extremely weatherproof and protected against harmful UV radiation. The solar panels are screwed onto the spoiler profiles. Therefore, it is possible to remove the solar system when changing your vehicle. The bracket itself is glued to the roof with a special adhesive. Adhesion has the advantage that no fixing holes need to be drilled into the roof. The solar systems' controllers come with the latest characteristics curves and can be switched from LiFePO4/gel/AGM to acid batteries. They also come with a second charging output (starter battery) and a connector for the solar remote display (optional). The solar controllers of the systems MTxxMC(-S) are

designed so that a panel of the same output can be added if required. A matching set of connecting cables for vehicles with EBL base station (Hymer Group vehicles) is included in the set.

Scope of delivery: MT Black Line solar panel(s) · solar controller MPPT with temperature sensor · roof spoiler set including accessories · cable routing to the roof · adhesive for spoiler and cable routing to the roof · cable set internal/external · cable kit for vehicles with EBL base station (Hymer Group) · small components · mounting instructions



Danger, H225, H315, H318, H336, H412, EUH066, EUH208, EUH210, EUH211



More? Online!

Number of panels 1	Nominal capacity	Daily output	Dimensions (L x W)	Weight	Item no.	Price
MT 75 MC-S	75 Wp	300 Wh	1470x335 mm	8 kg	323/400	599.00
MT 80 MC	80 Wp	320 Wh	1170x450 mm	8 kg	323/401	615.00
MT 110 MC	110 Wp	440 Wh	1335x530 mm	10 kg	323/402	755.00
MT 140 MC	130 Wp	520 Wh	1530x530 mm	12 kg	323/403	855.00
MT 170 MC	170 Wp	680 Wh	1600x660 mm	15 kg	323/404	999.00

Number of panels 2	Nominal capacity	Daily output	Dimensions (L x W)	Weight	Item no.	Price
MT 150-2 MC-S	150 Wp	600 Wh	1470x335 mm	15.5 kg	323/405	989.00
MT 160-2 MC	160 Wp	640 Wh	1170x450 mm	16 kg	323/406	1,019.00
MT 220-2 MC	220 Wp	880 Wh	1335x530 mm	20 kg	323/407	1,405.00
MT 280-2 MC	260 Wp	1040 Wh	1530x530 mm	24 kg	323/408	1,509.00
MT 340-2 MC	340 Wp	1360 Wh	1600x660 mm	30 kg	323/409	1,899.00

+ Accessories

Solar remote displays

With these additionally available displays, you can surveil all of the offered all-in-one systems. Easiest installation with the plug system.

📖 Main catalogue

We recommend ordering accessories together with your order. Details in the main catalogue on page 571.

DCC Charging Converter PerfectPower from 205.00



This DC charging converter ensures that the supply battery is always optimally charged while you are driving, so that you never arrive at your destination with an empty battery. Highly recommended for modern Euro 6 class vehicles with intelligent alternators. Also recommended for vehicles in which the cable cross-section is not sufficient to supply the connected devices.

- The supply battery is optimally charged while driving.
- Reliable solution for Euro 6 compliant vehicles
- Stable output voltage – suitable as permanent power supply for sensitive devices
- Advanced IUoU charging technology – adapts to all battery types, even lithium batteries with BMS (battery management system). Required charging voltage can be set via DIP switches. This ensures that lithium batteries are optimally charged.
- Simple configuration thanks to DIP switches on the outside – you do not need to open the housing.
- Temperature-compensated charging with optional temperature sensor
- Elegant housing – exclusive Dometic design

✓ Optimum battery charging while driving

Operating temperature:
-20 – +50 °C

Output voltage: 12 V

	Charging current	Dimensions (W x H x D)	Weight	Item no.	Price
DCC 1212-10	10 A	153x73x180 mm	1.25 kg	323/337	205.00
DCC 1212-20	20 A	153x73x220 mm	1.55 kg	323/338	305.00
DCC 1212-40	40 A	153x73x260 mm	1.85 kg	323/339	415.00

Output voltage: 24 V

	Charging current	Dimensions (W x H x D)	Weight	Item no.	Price
DCC 2412-20	20 A	153x73x220 mm	1.55 kg	323/340	235.00
DCC 2412-40	40 A	153x73x260 mm	1.85 kg	323/341	405.00



Inverter: 230 V from the RV battery

MT inverters are "Made in Germany" and guarantee an optimal 230 V supply from the RV battery – anywhere and at any time.

Inverters of the MT series operate as pure sine wave inverters and are consequently suitable for even the most sensitive energy consumers on board (e.g. coffee machines by Saeco, Jura, Senseo, etc.). The MT 600 SI-N is already sufficient for operating TV/SAT, video units, DVD, computers or battery chargers. For larger energy consumers, inverters with 1200 W or 1700 W are available. All units are capable of handling overloads and are equipped with whisper fans as well as monitoring and shutdown functions. The operating unit with display options can be removed and mounted inside the vehicle as a remote control. An integrated load detection turns the units to energy-saving mode while they are not needed, or completely off, if need be. The larger inverters are also available with an integrated mains switching function.

All inverters are delivered ready for connection with integrated socket and battery cable (1.2 m).

- Input voltage: 10.5 V up to 15 V
- Output voltage: 230 V AC/50 Hz, quartz-stabilised

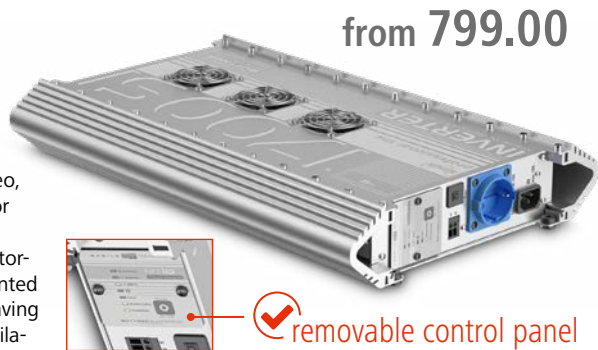

from 799.00



removable control panel

	Continuous output / Peak power	Dimensions (WxHxD)	Weight	Item no.	Price
MT 600 SI-N *	600/1200 W	335x70x270 mm	3.8 kg	322/124	799.00
MT 1200 SI-N *	1200/2000 W	400x70x299 mm	6 kg	322/145	1,149.00
MT 1200 SI **	1200/2000 W	400x70x299 mm	6 kg	322/132	1,069.00
MT 1700 SI **	1700/3000 W	480x70x299 mm	7.1 kg	322/146	1,219.00
MT 1700 SI-N *	1700/3000 W	480x70x299 mm	7.1 kg	322/149	1,275.00

* with switching system, ** without switching system

Optimal Charging for Recreational Vehicles

Charging RV batteries is rarely ideal. Most of the time, the 230 V charge is too weak, does not have the right characteristics and is simply not sufficient while driving. Newer vehicles (Euro 5 and Euro 6), which are equipped with a shutoff option of the alternator, do not charge the battery intermittently. This results in partly charged batteries, fast performance degradation and an early failure. Büttner Elektronik has the ideal solution "made in Germany".



749.00

Battery Control Booster MT BCB 25/20 IUoU

The **Battery Control Booster MT BCB 25/20** by Büttner Elektronik is the ultimate 3-in-1 solution for optimally charging your RV battery/batteries. The booster can be installed in parallel to the existing charging technology in the recreational vehicle.

322/496 749.00

BÜTTNER
→ **DOMETIC**



from 469.00

IUoU Charging Booster MT

Finally, it is possible to guarantee optimal and quick charging even while driving: simply connect the IUoU charging booster to the charging cable of the RV battery. The devices are available with several power levels. Thanks to the IUoU charging characteristics, they not only increase the charging current from the alternator when required, but also raise the charging voltage to the value that is necessary for the respective battery type for a full charge and is required by the battery manufacturers.



MADE IN GERMANY

255.00



Battery Computer MT iQ BASIC^{PRO}

Exact display of the available battery capacity. Provides information on capacity (Ah and %), voltage (V) and current flowing (A). Simple installation thanks to induction sensor on the on-board battery.

Scope of delivery:

Induction sensor and device housing (integrated as well as surface-mounted installation possible)

322/833 255.00

without illustration: Cable Extension for MT iQ Basic

Cable length: 5 m. 323/140 39.95

Connection Cable Set for Charging Booster LB 50

Simplifies installation because all cables and fuses needed are already included.

322/848 80.95

FIAT DUCATO installation suggestion

An ideal location for additional on-board electronics is behind the original seat console of the Fiat Ducato under the plastic cover. Remove it and attach either the universal mount or the complete mount. BCB 25/20 and the charging boosters LB 30 and LB 50 fit on the universal bracket. Original holes are used to install the mounts.



Original covering panel



Space for BCB 25 + LB 30 + 50



42.95

Universal Mount for Fiat Ducato

Scope of delivery:

2 x angle bracket, mounting material, foam rubber.

322/560 42.95

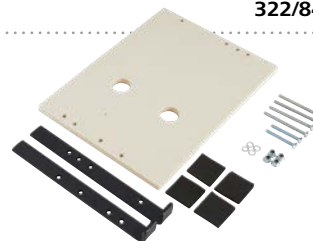

64.95

Complete Mount Fiat Ducato

If the seat base is not entirely blocked, there is an additional mounting possibility on its inside. Solar regulators, security and relay switches can be placed there. The complete mount consists of a universal holder and a ready-to-install, pre-screwed mounting panel. 322/562 64.95



✓ Including remote control from 600 W onwards.

BEST SELLER



from 139.00

Sine Wave Inverter SinePower DSP

The SinePower DSP sine wave inverters deliver pure sine wave voltage, which optimally supplies even sensitive 230 V devices. Due to the large input voltage range, they also work perfectly in modern Euro 6 vehicles. In the event of overload, overheating, overvoltage or undervoltage, the clever inverters switch off as a precaution – and switch on again automatically when everything is fine again. The integrated

ventilation adjusts flexibly to the load and temperature conditions and runs quietly. With the models from 600 W onwards, a remote control is included in delivery and the devices feature an energy-saving standby mode.

DOMETIC
OUTDOOR



The remote control with ON/OFF/STANDBY is included in delivery for all DSP models with a continuous output of more than 600 W.

	Nominal voltage	Continuous output	Peak power	Dimensions (W x H x D)	Weight	Item no.	Price	
1	DSP 212	12 V	150 W	300 W	126x50x188 mm	1.1 kg	323/300	139.00
2	DSP 412	12 V	350 W	700 W	126x50x188 mm	1.2 kg	323/302	149.00
3	DSP 612	12 V	600 W	1200 W	230x80x220 mm	2.8 kg	323/304	335.00
3	DSP 1012	12 V	1000 W	2000 W	230x80x240 mm	3.1 kg	323/306	499.00
3	DSP 1512	12 V	1500 W	3000 W	272x97x340 mm	4.9 kg	323/308	689.00
3	DSP 2012	12 V	2000 W	4000 W	272x97x360 mm	5.2 kg	323/310	879.00

Sine Wave Inverter SinePower DSP-T

This convenient sine wave inverter converts battery current into pure 230 V alternating current. This ensures reliable operation of electrical appliances up to 1200 W with power from the vehicle battery.

The intelligent mains priority circuit ensures smooth switching from battery current to mains current when the vehicle is connected to the mains. If not needed, the inverter switches to the energy-saving smart standby mode. It switches back on automatically as soon as the preset "wake-up" range is reached. With the elegant control panel (please order separately), all settings can be made conveniently and flexibly.



from 889.00

✓ Ideal for Euro 6 vehicles with smart alternator

premium inverter

Highlights:

- Battery-saving mains priority circuit
- Energy-saving smart standby mode
- The pure sinusoidal output voltage of 230 V AC is suitable for sensitive electrical appliances.
- Smart standby mode saves energy when the device is not in use
- User interface for perfect operation and control
- CI bus compatible – can be easily integrated into the vehicle network
- Integrated mains priority circuit with voltage synchronisation
- Large DC input voltage range – ideal for Euro 6 compliant vehicles
- Load- and temperature-controlled, low-noise fan

	Nominal voltage	Continuous output	Peak power	Dimensions (W x H x D)	Weight	Item no.	Price
DSP 1312T	12 V	1300 W	2400 W	28.4x11.8x40.5 cm	4.8 kg	323/312	889.00
DSP 1812T	12 V	1800 W	3600 W	28.4x11.8x40.5 cm	6.1 kg	323/314	1,119.00
DSP 2312T	12 V	2300 W	4000 W	28.4x11.8x48.1 cm	6.6 kg	323/316	1,814.00
DSP 3512T	12 V	3500 W	6000 W	32.4x12.2x49 cm	10.9 kg	323/318	2,365.00



More? Online!

⊕ Accessories



82.95

Remote Control SinePower

This convenient remote control was developed for controlling all sine wave inverters of the Dometic DSP-T series and features the most important standard functions: On, Off and Smart Standby. Optionally available as accessory.

- Convenient remote control for the most important functions: On, Off and Standby
- Easy operation at the touch of a button

Dimensions (W x H x D): 80x55x28 mm;
Weight: 100 g **323/322** **82.95**



154.95

Control Panel SinePower

This versatile control panel for DSP-T inverters offers maximum convenience. It controls all basic functions (On, Off, Smart-Standby), displays important performance parameters, and can be configured and expanded as needed. By connecting a bat-

tery sensor (item no. 323/336), it becomes an intelligent energy monitoring device that allows you to control the batteries' charging status at any time. An MCA charger can also be programmed via the control panel and switched to silent night mode at the touch of a button.

323/323 **154.95**

without illustration:

Cable Set for Sine Wave Inverters

The Dometic SinePower MSI-CCBL connects Dometic SinePower sine wave inverters to the vehicle battery.

1000 1300 W	323/325	77.00
1500 1800 W	323/326	94.00
2000 2300 W	323/327	105.00

159.00

Battery Sensor for MCA Chargers

This battery sensor measures the RMS current and the voltage of the connected battery and then calculates both capacity and charging status. It gives a warning signal if the battery is empty or defective.



323/336 **159.00**

Solar Controller MPPT SmartSolar

Including Bluetooth Smart

The wireless solution for setting up, monitoring and updating the SmartSolar charge controller. For a wired data connection with a Colour Control GX, other GX products, a PC or other devices.

Ultra-fast Maximum Power Point Tracking (MPPT)

Particularly in cloudy conditions, when the light intensity is constantly changing, an extremely fast MPPT controller improves the energy yield by up to 30 % compared to PWM charge controllers and by up to 10 % compared to slower MPPT controllers.

Features:

- Protection class: IP43
- Connections: screw terminals for max. 6 mm² cable
- VE.Direct for data exchange
- Max. short-circuit current controller: 13 A
- Nominal PV power 12/24 V: 145 W/290 W
- Max. solar voltage: 75 V



Nominal voltage:

12 V, 24 V

NEW

MPPT 100/20

Nominal capacity: 12 V / 290 W
Nominal capacity: 24 V / 540 W
Nominal capacity: 48 V / 580 W
Charging current: 20 A; Dimensions (WxHxD): 131 x 100 x 60 mm;
Weight: 700 g

322/383 114.95

MPPT 100/30

Nominal capacity: 12 V / 440 W
Nominal capacity: 24 V / 880 W
Charging current: 30 A; Dimensions (WxHxD): 186 x 130 x 70 mm;
Weight: 1.3 kg

322/384 163.95

MPPT 100/50

Nominal capacity: 12 V / 700 W
Nominal capacity: 24 V / 1400 W
Charging current: 50 A; Dimensions (WxHxD): 186 x 130 x 70 mm;
Weight: 1.3 kg

322/385 234.95

MPPT 75/10

Nominal capacity: 12 V / 145 W
Nominal capacity: 24 V / 290 W
Charging current: 10 A; Dimensions (WxHxD): 113 x 100 x 40 mm;
Weight: 400 g

322/381 78.95

MPPT 75/15

Nominal capacity: 12 V / 220 W
Nominal capacity: 24 V / 440 W
Charging current: 15 A; Dimensions (WxHxD): 113 x 100 x 40 mm;
Weight: 500 g

322/382 85.95

Battery Monitor

The BMV-7xx is a high-precision battery monitor. The main function of a battery monitor is to calculate the ampere-hours consumed and the state of charge of a battery. The ampere-hours consumed are calculated by integrating the current flowing into or out of the battery. Only type BMV-702 and BMV-712 Smart monitor the centre point voltage.



Dimensions (HxØ):

3 x 6.5 cm;

Weight: 500 g

NEW

from 147.95

Type: BMV-700

322/770 147.95

Type: BMV-702

322/771 183.95

With integrated Bluetooth.

Type: BMV-712 Smart

322/772 211.95

Type: BMV-712 Smart Black

322/773 211.95

VE.Direct Bluetooth Smart Dongle

The VE.Direct Bluetooth Smart Dongle connects to a non-Bluetooth enabled VE.Direct Victron product, which can then be accessed via Bluetooth using the VictronConnect app to facilitate monitoring, setup and firmware updates.

322/779 54.95



NEW

54.95

from 78.95



from 232.95

Battery Charger Blue Smart IP22

Blue Smart IP22 Charger is the new professional battery charger with built-in Bluetooth! It can be used with devices in your workshop or with motor vehicles such as (classic) cars, motorbikes, boats and motor-homes.

The wireless solution for monitoring voltage and current, changing settings and updating the charger when new functions are available. With an efficiency of up to 93 %, these chargers generate up to four times less heat compared to the industry standard. The Blue Smart Charger has a microprocessor-controlled "adaptive" battery management system. The adaptive function automatically optimises the charging process depending on the way the battery is used.

1 output

Nominal voltage: 12 V
Charging current: 30 A
Dimensions (WxHxD): 23.5 x 6.5 x 10.8 cm
Weight: 1.4 kg

322/730 232.95

3 outputs

Nominal voltage: 12 V
Charging current: 30 A
Dimensions (WxHxD): 23.5 x 6.5 x 10.8 cm
Weight: 1.4 kg

322/731 260.95



NEW

from 197.50



NEW

Phoenix Inverter VE.Direct

Inverters can be used to supply power to household appliances that require 230 V/120 V AC. Batteries for leisure applications or car batteries rated at 12 V DC are used for this purpose.

Type Phoenix 12/500

Continuous output: 400 W
Peak power: 900 W; Dimensions (WxHxD): 17.2 x 27.5 x 8.6 cm
Weight: 3.9 kg

322/720 197.50

Type Phoenix 12/800

Continuous output: 650 W
Peak power: 1500 W; Dimensions (WxHxD): 21.6 x 30.5 x 10.5 cm
Weight: 5.5 kg

322/721 321.95

Type Phoenix 12/1200

Continuous output: 1000 W
Peak power: 2200 W; Dimensions (WxHxD): 23.2 x 36.2 x 11.7 cm
Weight: 7.4 kg

322/722 424.95



Charger Xenteq LBC 512-10S

Microprocessor-controlled universal HF charging device in a compact housing. Suitable for LiFePO₄/LiFeYPO₄ Li-Ion as well as for AGM, gel and wet batteries. **Safe, fast and yet gentle charging with automatic soft start function.** Enjoy a battery that is always charged as long as it is connected to the charger. The restart function automatically starts the recharge process as soon as the battery voltage is dropping. Thanks to the automatic wake-up function, batteries with a battery management system in "sleep mode" are reactivated without any problems. The 6 LEDs allow an easy indication of charging and operating condition as well as error messages. Equipped with temperature control sensor input.

- **Suitable for:** LiFePO₄, wet, gel, AGM, AGM² – 13.5 V
- **LiFePO₄ mode:** 14.4 V, automatic restart at U < 13.3 V
- **Automatic wake up function:** automatic waking up of deep-discharge batteries
- **Charging periods:** pre-charge, soft start and constant current
- **Charging current monitor/safety timer:** to end CV phase.
- **Auto-restart:** after voltage drop
- **Passively cooled, silent**
- **Power supply mode:** 13.5 V

Scope of delivery:

charger, manual, clamps, M8 cable lugs.
IP protection class: IP25; Dimensions (W x H x D): 20.4 x 5.9 x 13.3 cm; Weight: 1 kg

322/101 149.95

Temperature Sensor for Charger LBC 512-10S

Temperature sensor (cable approx. 5 m) for the charging unit LBC 512-10s. **322/101-1 23.95**



from **179.00**

Starter battery
RV battery

AGM Battery Powerboozt Dual Purpose

PB AGM is a VRLA (Valve Regulated Lead Acid) battery produced with AGM (Absorbent Glass Mat) technology according to the EN 60254-1 standard.

Lithium Battery Tempra 150

Premium lithium battery 150 Ah with the new generation of HDP cells (High Density Power) – small and compact. The battery has an N-Bus and a CI-Bus interface. The Display Bus and/or the mobile app inform you about the battery's charge status. Thanks to an internal DC-DC charger, all charging sources can be used. A charging booster is required for use in a motorhome. Version F has an innovative heating system and enables operational readiness down to -30 °C.

Capacity: 150 Ah
Dimensions (W x H x D): 341 x 176 x 190 mm
Weight: 16.1 kg

NEW RV battery

Tempra 150 323/430 1,374.00
Tempra150F 323/431 1,484.00



729.00

Powerboozt Lithium Battery

Rechargeable lithium iron phosphate battery for camping and boats with integrated BMS system. Compared to lead-acid and other lithium batteries, lithium iron phosphate batteries offer significant advantages, including improved discharge and charge efficiency, longer life and the ability to be discharged deeper while maintaining performance.

Advantages:

- LiFePO₄ technology is particularly safe
- All batteries certified according to UN38.3
- 1:1 replacement for lead-acid batteries
- Very light (approx. half the weight)
- Very long life
- More usable capacity
- Constant power during discharge
- Temperature-resistant
- Fast and safe charging
- Can be operated and stored in a partially charged state
- Intermediate charging possible
- Low self-discharge
- Maintenance-free
- Bluetooth 4.0 with Android/iOS app
- No dangerous acid

PB-Li 12-100 L5

Capacity: 100 Ah; Dimensions (W x H x D): 353 x 190 x 175 mm; Weight: 12 kg **322/861 729.00**

PB-Li 12-150 L5

Capacity: 150 Ah; Dimensions (W x H x D): 353 x 190 x 175 mm; Weight: 15 kg **323/356 1,099.00**

Advantages:

- 30 % higher energy density compared to wet batteries
- Very low self-discharge rate
- Very good current consumption and current output
- No corrosive fumes (thus suitable for the food and the pharmaceutical industry)
- Robust design, vibration-resistant
- Low charge factor (1.08) reduces energy consumption during charging
- Electrolyte immobilised in the AGM (thus preventing leakage in case of damage to the casing)
- Completely maintenance-free – simply install and forget
- Charging voltage 14.4 – 14.8 V
- Trickle charge 13.5 – 13.8 V
- Max. charging current 30 % of C20 (e.g. 30 A for 100 Ah C20)
- 400 cycles according to IEC/EN 60254-1

Maintenance-free



PB-70 AGM

Capacity: 70 Ah; Dimensions (W x H x T): 278 x 190 x 175 mm
Weight: 21 kg

322/871 179.00

PB-95 AGM

Capacity: 95 Ah; Dimensions (W x H x T): 353 x 190 x 175 mm
Weight: 26 kg

322/872 245.00

BÜTTNER
DOMETIC

from **1,374.00**



299.00



RV battery

AGM Battery Powerboozt Deep Cycle

The Powerboozt battery was developed specifically for recreational vehicles, electric motor boats and yachts. Thanks to AGM (Absorbent Glass Mat) technology, it can provide huge energy reserves and operate a wide range of additional electrical equipment during its long service life. The minimal self-discharge makes it perfect for seasonal use and absolutely maintenance-free.

Advantages:

- Perfect for demanding recreational vehicles
- AGM technology for outstanding shock and vibration resistance
- Extremely durable with up to 8 times the cycle life of conventional batteries (up to 800 cycles at 50 % discharge)
- Robust and leakproof
- Ideal for your starting and supply needs
- Completely maintenance-free

PB110

Capacity: 110 Ah
Dimensions (W x H x D): 331 x 220 x 176 mm
Weight: 33.3 kg **322/867 299.00**

ECO FLOW

Folding Solar Panel EcoFlow

High-efficiency solar panels: This one-piece, foldable solar panel is perfect for at home and for camping. With a high solar output and an improved efficiency of 23 %, you can charge your portable power station even faster than before.

Self-supporting: The protective case conveniently folds out into a sturdy stand that adjusts from 40° – 80° to allow the flexible solar panel to catch the most rays.

Durable and lightweight: Made from flexible EVA and durable fibreglass. The low weight, the robust design and the integrated shoulder strap make the panel ideal for outdoor use.

Weatherproof: Each monocrystalline silicon cell is covered with an ETFE film that protects it from dirt and water. Thanks to the IP68 waterproof rating, this portable solar panel works safely in any weather.

Foldable and portable: The solar panel is easy to assemble and disassemble. After use, it can be safely stored in the combined protective bag for transport and storage.

from 279.00



NEW

Nominal capacity: 110 Wp; Daily output: 440 Wh; Dimensions (WxHxD): 157x2x48 cm; Weight: 5.65 kg **323/394 279.00**

Nominal capacity: 160 Wp; Daily output: 640 Wh; Dimensions (WxHxD): 183x2.5x82 cm; Weight: 9.96 kg **323/368 349.00**

NEW

Nominal capacity: 220 Wp; Daily output: 880 Wh; Dimensions (WxHxD): 183x2.5x82 cm; Weight: 9.96 kg **323/395 499.00**

Nominal capacity: 400 Wp; Daily output: 1600 Wh; Dimensions (WxHxD): 236.5x2.5x105.8 cm; Weight: 16 kg **323/367 949.00**

Extension Cable MC4 Connector; Dimensions (L): 3 m **323/372 49.00**

MC4 Connector to XT60 Solar Cable; Dimensions (L): 3.5 m **323/373 29.00**

MC4 Connector to XT60 Solar Cable; Dimensions (L): 5 m **323/374 39.00**

Powerstation RIVER

The portable power stations with fast charging function are perfect for your next camping holiday. Equipped with different power outputs and a capacity between 256 Wh and 768 Wh, the EcoFlow RIVER solar batteries can power several devices at the same time – be it mobile phone, laptop or household appliance. Thanks to the patented X-Stream function, the RIVERS can be charged from 0 to 100 % in just one hour. Since they can also be charged with solar energy, they are particularly environmentally friendly and sustainable and provide you with renewable energy while camping. It is not for nothing that the EcoFlow RIVER series power stations are among the best portable lithium batteries on the market.



from 229.00



RIVER 2

Continuous output: 300 W; Capacity: 256 Wh; Short-term peak power 600 W; outputs (9): AC, DC, USB-A, USB-A Fast Charge, USB-C, car. Dimensions (WxHxD): 24.5 x 14.2 x 21.4 cm Weight: 3.44 kg **323/369 229.00**

RIVER 2 Max

Continuous output: 500 W; Capacity: 576 Wh; Short-term peak power 1000 W; outputs (9): AC, DC, USB-A, USB-C, car. Dimensions (WxHxD): 27 x 19.6 x 26 cm Weight: 6.12 kg **323/370 499.00**

RIVER 2 Pro

Continuous output: 800 W; Capacity: 768 Wh; Short-term peak power 1600 W; outputs (9): AC, DC, USB-A, USB-C, car. Dimensions (WxHxD): 27 x 22.6 x 26 cm Weight: 7.9 kg **323/371 699.00**

ECO FLOW

NEW



2,099.00

DELTA 2 Max

Continuous output: 2400 W; Capacity: 2048 Wh; Short-term peak power 4800 W; outputs: 4 x AC, 2 x DC, 2 x USB-A, 2 x USB-A Fast Charge, 2 x USB-C, 1 x car. Dimensions (WxHxD): 49.7 x 30.5 x 24.2 cm; Weight: 23.15 kg **323/383 2,099.00**

Powerboozt Powerstation

Countless application possibilities indoors and outdoors. Ideal for camping, outdoor activities or in the garden – whenever you cannot find a power socket. The compact power station can reliably charge or operate your devices such as mobile phones, laptops, Bluetooth speakers, coolers, etc. The display provides you with detailed information about charging or remaining

discharge time, battery status and current consumption.

During the day, you have three options for recharging the power station: via socket, 12 V car socket or solar panel (solar panel not included). Protection against overvoltage, undervoltage, overtemperature, overload, short circuit at AC output.

Battery type: lithium-ion battery.

POWER BOOZT

from 1,295.00



PB PS 1000

Continuous output: 1000 W; Short-term peak power 2000 W; output voltage: 2 x 230 V/50 Hz; 1 x 12 V/10 A, 4 x USB Quick Charge 3.0 Capacity: 1028 Wh Dimensions (WxHxD): 352 x 260 x 187 mm; Weight: 10.5 kg **323/350 1,295.00**

PB PS 1500

Continuous output: 1500 W; Short-term peak power 3000 W; output voltage: 2 x 230 V/50 Hz; 2 x 12 V/10 A, 4 x USB Quick Charge 3.0 Capacity: 1461 Wh Dimensions (WxHxD): 352 x 260 x 187 mm; Weight: 12.5 kg **323/352 1,559.00**



HINDERMANN



from 8.35

Cable Safe Schuko

Cable Safe CEE

Cable Safe

Protect your cable connection (plug and coupling) against rain or moisture when working outdoors. The safe ensures that connections do not fall apart and young children are not endangered.

Schuko	321/039	8.35
CEE	321/039-1	13.25

HABA

happy campers



Delivery without cable reel.

32.50

Cable Reel Bag

The convenient storage bag protects your cable reel from moisture, dirt, sand and damage. The 4-way zip gives access to the carrying handle. An additional side opening with cover flap enables power connection. The cable reel is also protected and close at hand outdoors. The lightweight tarpaulin can be washed on the outside and inside. For 25 m cable reel.

Dimensions (WxHxD)	33x40x22 cm
Weight	400 g
321/930	32.50

HABA

happy campers

20.50

✓ For up to 40 metres

Cable Reel Crusader

Roll up to 40 metres of cable (3 x 2.5 mm²) onto the cable reel to avoid cable tangles. Dimensions (WxHxD): 37 x 12.5 x 36 cm; Weight: 680 g

321/061	20.50
----------------	--------------

EuroTrail

13.95

Storage Bag Cable

Ideal bag for storing your extension cable. Your cable will never get tangled or lost again. Spacious zip opening and carrying straps. The round shape of the bag makes it easy to stow away the rolled cable.

Dimensions (HxØ)	10x45 cm	Weight	230 g
611/903	13.95		



brennenstuhl®

... smart technology.

from 26.95



BEST SELLER

MADE IN GERMANY

Extension Cable Camping CEE-CEE/Schuko

Extension cable with CEE/Schuko angle connector and CEE plug. For connecting a power source to your caravan, motorhome or boat. IP44, cable H07RN-F 3G2.5mm². 230 V | 16 A | IP44

orange		
1.5 m	321/090	26.95
10 m	321/088	59.95
25 m	321/089	114.95



24.50

230 V | 16 A | IP44

Adapter Cable Schuko -> CEE

Adapter cable especially suitable for the power supply of caravans, boats, construction trailers, yachts, motorhomes, etc. With Schuko plug to CEE coupling. Cable H07RN-F 3G2.5mm².

orange	1.5 m	321/086	24.50
--------	-------	----------------	--------------

BEST SELLER



27.50

230 V | 16 A | IP44

Adapter Cable CEE -> Schuko

Adapter cable especially suitable for the power supply of caravans, boats, construction trailers, yachts, motorhomes, etc. With CEE plug on Schuko coupling. IP44.

orange	1.5 m	321/087	27.50
--------	-------	----------------	--------------

The new cable reels by Frankana have been developed for camping in particular. Made in Germany, with rewind aid. The extremely compact design makes these cable reels a must-have for your next camping holiday.

brennenstuhl®

... smart technology.

✓ Extremely compact design!

25 m
99.95



Cable Reel Schuko 240

The 240 cable reel with 25 m cable length H07RN-F 3G1.5 and winding aid. IP protection class: IP44; Cable length: 25 m; Nominal voltage: 230 V; Nominal current: 16 A; Dimensions (LxWxHxØ): 19x25x34x24 cm; Weight: 4.9 kg

321/092	99.95
----------------	--------------

✓ Extremely compact design!

25 m
175.95



Extension Cable Reel CEE Camping 240

The extremely small cable reel convinces with quality and safety. Extension cable: 25 + 2 m, H07BQ-F3G2.5, CEE-CEE/Schuko. IP protection class: IP44; Cable length: 25 m; Nominal voltage: 230 V; Nominal current: 16 A; Dimensions (LxWxHxØ): 23x25x34x24 cm; Weight: 5.2 kg

321/093	175.95
----------------	---------------

✓ Extremely compact design!

25 m
175.95



Cable Reel CEE Camping 240

The extremely small CEE cable reel for permanent outdoor use (IP44), with 2 CEE sockets, 25 m H07BQ-F2.5. With 1-pole safety cut-out and overheating protection. IP protection class: IP44; Cable length: 25 m; Nominal voltage: 230 V; Nominal current: 16 A; Dimensions (LxWxHxØ): 23x25x34x24 cm; Weight: 5.1 kg

321/094	175.95
----------------	---------------

MADE IN GERMANY

CABLE PILOT

FF Kollektion



26.95

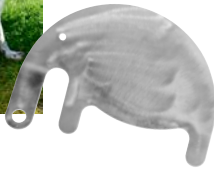

MADE IN GERMANY

Dog Sitter Elefant

The dog sitter Elefant can be used without drilling or installation. You simply drive onto it with your vehicle and the dog sitter is ready – invented by campers for campers.

- No drilling necessary
- Low weight
- Stainless steel
- Immediately ready for use
- Easy to use
- Safe pet

Dimensions (W x H x D): 30 x 4 x 22 cm; Weight: 680 g **214/318 26.95**



13.50



Car Safety Belt for Dogs

This safety belt protects your dog from becoming a dangerous projectile in the event of an accident or sudden braking. Thanks to the adjustable belt, your dog will still have moderate mobility. This way, your dog will no longer distract you while driving. The car safety belt can be used with the existing belt buckle.

Dimensions (L x H): 78 x 2.5 cm **551/210 13.50**

NEW



from 6.50



Odour and Stain Remover Bactador

With Bactador microbiology, odours and stains are removed permanently and down to the pores. Ideal for reliable use in caravans, motorhomes, cars or tents.

Permanently odour-free at last

- Permanent odour removal with natural Bactador microbiology
- Reliable for the most stubborn odours (urine, faeces, vomit, etc.)
- The alternative to chemical cleaners
- Pleasantly fresh scent
- Dermatologically tested with "Excellent"

100 ml	65.00/l	450/472	6.50
750 ml	18.00/l	450/471	13.50

Omnia Oven

Simple and sturdy design

Using the Omnia is simple and does not require installation. The tried and tested oven is suitable for almost any stove (not suitable for induction stoves). You can find the user manual under the item no. on www.frankanafreiko.com.

Material: steel sheet/aluminium. Volume capacity: approx. 2 l.

Three parts

Omnia consists of three parts. The aluminium mould, into which the ingredients or the dough are placed, resembles a round cake mould with a hole in the middle. A special stainless steel base is located beneath it. The aluminium lid has small air holes and is high enough so that the bread or cake can rise properly.

Top and bottom heat

The heat of the oven is transported to the bread or pastries by convection and thanks to the oven's shape, there is both top and bottom heat. Not suitable for food with a high acid and/or salt content. Not dishwasher-safe.

Oven Kit 1

The Kit 1 consists of 5 parts: Omnia camping oven, silicone mould, baking rack, storage bag, pot holder set. **320/013 104.75**

Auflauf, Quiche, Pizza & Co.

A successful mix of classics and original variations. You will find the best and most delicious recipes in this cookbook with step-by-step instructions and many alternative recipe suggestions. It is a culinary journey through the cuisines. **066/152 14.95**



104.75



14.95



34.90

NEW

Camping Guide 2024

Discover 150 adventure campsites in Germany that you definitely do not know yet! Make 2024 your camping year! This camping guide takes you to the most beautiful regions in Germany. Away from the crowds, you will discover 150 unique camping pitches with an experience factor – from private hosts, far away from the stress of everyday life! Language: German. **066/171 34.90**

184.95

Stainless Steel Water Filter Travelbuddy

With the portable stainless steel water filter, water filtration is not only child's play, but also becomes an eye-catcher. Clean drinking water in approx. 30 seconds.

Scope of delivery:

- Filter for 1300 litres of clear water
- Stainless steel top and bottom tanklid
- Connector
- Lid with valve attachment
- Seals
- Hand pump
- Access to the free app

NEW

455/150 184.95



34.95



- ✓ Up to 1300 l
- + Accessoires



NEW

Replacement Filter for Travelbuddy

Replacement filter for 1300 litres of clean water. Filters water sources worldwide and removes turbidity and suspended particles, chlorine, microplastics, bacteria and viruses. Replaceable, can be stored for 10 years. Material: activated carbon, electro-adsorption fleece, bio-based plastic. **455/151 34.95**



Resty Garbage Separator

Waste separation made easy – the Resty convinces with various application possibilities in small spaces. With three fastening options, it is perfectly suitable for indoors and outdoors. Quick to set up and dismantle. Suitable for 10 l bin liners.

Scope of delivery: Resty garbage separator, 10 l bin liners.

Material: plastic; Capacity: 3 x 10 l; Dimensions (WxHxD): 15x8.1x20.3 cm; Weight: 196 g

430/010 18.95

+ Accessories

Pole Resty 430/006 7.95
Ground Sleeve 610/119 10.95



3 x 10 l

18.95

✓ Small-scale waste separation!

Rechargeable Outdoor Solar Light GL 400 AS

UV-resistant LED lamp with anti-slip rubber coating and fold-out bracket. With replaceable standard 18650 Li-ion battery, rechargeable via USB-C cable or solar panel. Incl. 3 switching levels (100 %, 50 % or 10 %) and power bank function. IP44. Capacity: 3 Ah. Battery type: 18650. Battery technology: Lithium-ion. Nominal voltage: 3,7 V; Luminous flux: 350 lm; Dimensions (HxØ): 10 x 12 cm; Weight: 350 g

320/461 39.95



NEU

brennenstuhl®
...smart technology.

39.95

✓ Powerbank-funktion

Genius
Einfaßk genial!

89.95



✓ Powerful, efficient and space-saving!

Handheld Vacuum Cleaner Invictus One 1.0

Maximum power in a compact format. The Invictus One is a compact, light, cordless handheld vacuum cleaner with a high-performance BLDC motor. With its 2.5 times suction power, it deep cleans all surfaces and upholstered furniture. The Invictus One can be used anywhere and at any time. Whether it is dirt on the sofa, in the car or in hard-to-reach places like cupboards, this vacuum cleaner reaches every niche, no matter how small. Set (9 pcs.). Nominal voltage: 230 V; Nominal capacity: 90 W; Dimensions (LxWxH): 41.8x7.3x3.7 cm; Pack size: 44 x 16 x 10 cm; Weight: 930 g

324/005 89.95

BRUNER
OUTDOOR IN MOTION



12.50

Folding Bucket Fold-Away

The folding bucket Fold-Away was inspired by the popular multi-purpose bucket Vinis. Made of heat-resistant, shatterproof and easy-to-clean TPE plastic. Can be folded to save space when not in use. With plastic transport handle. Food-safe, heat-resistant up to 130 °C, break- and frost-resistant, incl. transport handle. Height with handle: 47 cm. Material: plastic; Capacity: 14 l; Colour: assorted colours; Dimensions (HxØ): 23x38 cm; Pack size: 41 x 40 x 9 cm; Weight: 562 g

550/276 12.50



EuroTrail

39.95

NEW

Folding Waste Bin with Sensor

Convenient, folding waste bin with infrared sensor. This ensures that the bin opens automatically as soon as you hold your hand at a distance of 20 cm above the bin. It closes automatically after approx. 5 seconds. Ideal for camping, boats or at home. Operated by two AA batteries that are not included.

Material: PP polypropylene, ABS acrylonitrile butadiene styrene; Capacity: 8,5 l; Dimensions (HxØ): 30.5x25 cm; Pack size: 25 x 25 x 11,5 cm; Weight: 1.05 kg

430/023 39.95



Portable Spotlight

47.95

The portable, battery-powered LED work light convinces with more flexibility and functions for versatile use. Thanks to the stable clip system (clamping width up to 55 mm), the compact LED work light can be easily attached to work surfaces, pipes, plates, etc. It therefore offers a bright, glare-free light and ensures that you have your hands free when working. The three switching levels (100%/50%/25%) allow individually adapted illumination. The shatterproof and impact-resistant plastic housing protects the LED spotlight from damage and offers IP65 protection (dust- & splash-proof). Thanks to the ball bearing and the integrated ball joint, the inclination angle of the LED construction spotlight can be flexibly adjusted by almost 360° and individually aligned in all directions. In addition, the work light equipped with SMD LEDs convinces with the following features:

- Lithium ion battery 3.7 V/2.5 Ah with charge indicator
- Lighting duration up to 12 h
- With integrated USB power bank
- USB charging cable type A/C
- Colour temperature: 6350 K
- Protection class: IK08

Technical Data:

Lithium ion battery 3.7 V/2.5 Ah with charge indicator, Lighting duration up to 12 h, integrated USB power bank, USB charging cable type A/C, Colour temperature: 6350 K, Dimensions (WxHxD): 19.2x10.5x10.3 cm, Weight: 400g

320/424 47.95

Rotary Clothes Dryer Maxi

12.95

Rotary clothes dryer with 18 arms (2 clothes pegs each). Dimensions when folded: 46 x 8 cm. Material: plastic; Dimensions (HxØ): 37x76 cm; Weight: 600 g

430/021 12.95



BRUNER
OUTDOOR IN MOTION

11.90

Dustpan and Brush Scoopy

Plastic sweeping set with a large dustpan. Very useful for those who are travelling with a caravan or motorhome. Dimensions (WxHxD): 23.5x10x34 cm; Weight: 175 g

610/929 11.90





MAGNETIC CAMPING KIT
flexiMAGS.

✓ Space-saving

96.95



MADE IN GERMANY

Drying Rack flexiMAGS

The convenient flexiMAGS drying rack impresses with its high quality and is suitable for vans and semi-integrated vehicles. Thanks to the four extra-strong magnets (ø 66 mm), optionally with black or white rubber coating, the drying rack sticks to sheet metal and does not slip even in windy conditions. Since the drying rack is extendible, you have plenty of space for your laundry. When the laundry is dry, simply tilt the drying rack slightly upwards or downwards to detach it from the vehicle wall. Quick and space-saving to stow away. Suitable for inside and outside. Material: stainless steel; Dimensions (LxWxH): 38.5x72x16 cm Pack size: 81 x 23 x 22 cm; Weight: 1.04 kg

black, silver	610/440	96.95
white, silver	610/441	96.95

BRUGGER
MAGNETSYSTEME

MAGNETIC CAMPING KIT
flexiMAGS.

MADE IN GERMANY



99.95

Waste Bin flexiMAGS

With two magnets ø 66 mm. Made of leakproof fabric, UV-resistant, folding & washable. If the surface you want to attach the magnets to is not made of steel, please additionally order the magnetic board 40 x 7 cm (610/423).

Capacity: 11.25 l;
Dimensions (WxHxD): 27.5 x 29.5 x 17.2 cm
Weight: 1.1 kg

610/439 99.95

MAGNETIC CAMPING KIT
flexiMAGS.

BRUGGER
MAGNETSYSTEME

Shower Curtain flexiMAGS

Outdoor shower curtain, space-saving, for your outdoor shower experience. No scratching of the paintwork thanks to magnetic fastening.

Scope of delivery: shower curtain, stainless steel folding arch, magnetic fastening, magnetic holder for shower head (1 x 43 mm rubberised magnet, 2 x ø 88 mm rubberised magnet, white), assembly instructions and transport bag. Material: 100 % PES polyester; Dimensions (Hxø): 160x90 cm;

Pack size: 120 x 26 x 12,5 cm; Weight: 2.6 kg
610/421 209.95

MADE IN GERMANY



209.95



48.00

1

Organiser

The front of this high quality, durable organiser can be rolled up or closed up by zippers to protect its content. The polyester-reinforced body can be easily connected to the POD-System 2.0 (item no. 71 990, not included in delivery) by large eyelets or firmly sewn on straps. A practical handle is integrated in the top of the body.

1 | Wall Organizer

With 14 pockets (incl. 2 net-pockets). Dimensions: 50 x 85 cm. **71 986 48.00**



48.00

2

2 | Shoe Organizer

With 10 spacious pockets to store shoes as well as 2 net-pockets for cleaning equipment. Several openings for optimal ventilation. Dimensions 55 x 80 cm. **71 987 48.00**

3



8.00

3 | POD System 2.0

Set of 2. Fastening system to easily fixate Thule organiser. No tools are needed for mounting, they are simply hooked in within seconds.

71 990 8.00

4



18.00

4 | Strap Set

2 pieces, to mount into the piping rail
71 992 18.00

5



148.00

5 | Magnetic Fastening Kit Set

Includes a channel rail at the bottom, into which the strap set (Item No. 71 992) can be pulled to hang up Thule Organizer. It can also be used to fixate the Thule van ladder (item no. 89 394) to the vehicle.

71 993 148.00



blackberry grey dark green cream white

7.25

NEW

New colours

water | light | energy

BEST SELLER

Anti-Slip Mat

Prevents slipping of items like tableware, carpets, etc. even while driving. The material is easy to cut. Thanks to a special impregnation, the mat is resistant to bacteria, mites and mildew. Washable up to 30 °C.

	Item no.	Price
blackberry	550/206-1	7.25
grey	550/206-2	7.25
dark green	550/206-3	7.25
cream white	550/206-4	7.25
blue	NEW 550/206-5	7.25



21.75

Froli

MADE IN GERMANY

Universal Glass/Cup Holder

Universal glass/cup holder made of soft rubber plastic. Protection against breaking during transport, suitable for common sizes, with cut-outs for cup handles, easy to clean and non-slip.

Dimensions (W x H x D): 25 x 6 x 34 cm; Weight: 93 g **550/014 21.75**

Transport Box FF

Stackable plastic box with two-part hinged lid that allows you to quickly and easily fill and empty the box. Fully closed side walls and base. Robust and easy to stack with closed lid. Space-saving storage thanks to slightly conical body. Open boxes can be easily nested inside each other. Material: plastic

Capacity: 21 l

Dimensions (W x H x D): 39.5 x 21.5 x 30 cm; Pack size: 39,5 x 30 x 21,5 cm; Weight: 1.32 kg **430/271 11.95**

Capacity: 32 l

Dimensions (W x H x D): 39.5 x 32 x 30 cm; Pack size: 39,5 x 32 x 30 cm; Weight: 1.49 kg **430/272 13.95**

Capacity: 60 l

Dimensions (W x H x D): 59.8 x 32.5 x 39.5 cm; Pack size: 60 x 40 x 32 cm; Weight: 3.05 kg **430/260 25.00**

11.95



NEU

new sizes



13.95



25.00

KiiPER[®] from 17.95

NEU

Storage Net KiiPER

With the flexible storage net KiiPER, you can determine your own storage space width. It is screwed in place and can only be dismantled with tools.

Consists of: lined net & sewn-on net holders, 2 brackets for attaching the net, 2 covers to fix the net on the console, 1 drilling template, 6 self-tapping screws 4.8 x 13 mm, 6 wood screws 5 x 17 mm. Separately available end strip.

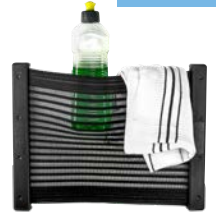

Size	Width	Item no.	Price
S	26 cm	250/660	17.95
M	33 cm	250/661	19.95
L	41 cm	250/662	23.90
XL	51 cm	250/663	29.90

Folding Box meiri Classic

The meiri folding box is always at hand to transport, organise or store something. All versions (available in 3 sizes) can be folded and unfolded in 3 easy steps. Unfolded, they can carry up to 30 kg of weight, closed they find a space in the smallest gap. They are extremely durable thanks to their high-quality material and perfect manufacturing. Whether as a travelling companion, helping hand for grocery shopping or as an individual storage solution for your home - there is always something you can use a meiri folding box for.



from 29.95

100 % PES polyester



Additional boxes can be found in the main catalogue starting from page 668.



meiri



Size	Dimensions (W x H x D)	Granite Grey	Azure Blue	Marine Blue	Price
S	32x27.5x26 cm	71 706	71 709	71 730	29.95
M	32x27.5x37 cm	71 707	71 711	71 731	34.95
L	32x27.5x50 cm	71 708	71 710	71 732	39.95



100 % PES polyester



from 13.95

Folding Box meiri Classic FF

The proven folding boxes by Meiri are now a part of the Frankana Freiko collection in all four sizes. With their neutral black, they match every environment, without being obtrusive.

Size	Item no.	Price
Mini	71 680	13.95
S	71 684	26.95
M	71 685	32.90
L	71 686	39.90





from 47.95

100 % CO₂ neutral

Tableware Set CLUB

The tableware set CLUB for two people comes in a modern faceted design and is a must-have for summer holidays with your RV or tent. All pieces are light, extremely robust, easy to clean and compactly stackable and can therefore be stowed in a particularly space-saving way. Dishwasher-safe and 100 % CO₂ neutral! BPA- and melamine-free!

Material: bio-circular plastic and FSC-certified wood, tumblers made of thermoplastic.

Tableware Set CLUB

The 8-piece set consists of:

- 2 dinner plates ø 26 cm
- 2 soup plates ø 22 cm
- 2 cereal bowls ø 16.2 cm
- 2 tumblers 250 ml

551/179 47.95

Tableware Set CLUB GÖTEBORG

The 16-piece set consists of:

- 4 dinner plates ø 26 cm
- 4 soup plates ø 22 cm
- 4 bowls ø 16.2 cm
- 4 tumblers 250 ml

551/262 89.95



Aluminium

Induction

Incl. bag

79.90



Extremely space-saving

Pot Set Pirate Spacemaster Mini

The pot set consists of:

- 1 pot ø 18 cm, H 8 cm, 2 l
- 1 pot ø 20 cm, H 9 cm, 2.5 l
- 1 pan ø 20 cm, H 5 cm, 1.5 l
- 1 lid ø 20 cm
- 1 pot gripper
- 1 pot and pan protector made of polyester felt

Suitable for all types of stoves incl. induction.

Material: aluminium; Pack size: 24 x 24 x 19 cm; Weight: 1.95 kg 551/610 79.90

21.95



MADE IN GERMANY



Kids Tableware Connect Harry

The tableware sets with the cute animal design are an absolute delight. The small plate is perfect for fruits and healthy snacks while the small bowl is great for cereal or small meals. Your children can easily grab the compact cup even with their small hands. It does not even need a handle. The Connect sets consist of 100 % bio-circular plastic and is free from BPA, melamine and formaldehyde. Of course, it can also be recycled completely and is dishwasher-safe. Consist of:

- 1 cup 7.5 cm, 190 ml
- 1 plate ø 20.5 cm
- 1 bowl ø 12.3 cm, 400 ml

550/723 21.95

NEW

9.95



PROMOTIONAL GIFT AWARD 2019



Cutlery Set KLIKK

All parts can be compactly plugged together. Stylish, robust, dishwasher-safe and 100 % CO₂-neutral.

Cutlery Set 3 pieces

sand 551/223 9.95
grey 551/224 9.95

COOK VISION

Stainless steel

Induction



327.00

Cookvision Starter Set

- 3 pots ø 16 cm, 1.3 l; ø 20 cm, 2.8 l; ø 24 cm, 5.1 l
- 3 glass lids ø 16 cm, ø 20 cm, ø 24 cm
- 1 pan, non-stick, ø 24 x 5 cm
- 1 long handle
- 2 silicone handles
- 1 trivet

Material: stainless steel

Pack size: 34 x 28 x 25 cm Weight: 5.4 kg 310/529 327.00

NEW



gumex



79.95

Tableware Series Vivid Line

Melamine

9.95

Vivid Line is a modern two-tone tableware collection with a combination of plain anthracite grey as the base colour and sophisticated trendy colours on the inside of the plates, bowls and cups. The tableware features GIMEX's unique non-slip, self-adhesive 3M strips for added comfort when enjoying meals on any occasion. The melamine tableware is lightweight, durable and easy to clean.

light blue, anthracite	Item no.	Price
Tableware Set 12 pieces	550/923	79.95
Egg Cup 4 pieces	550/925	9.95
Mug 380 ml 4 pieces	550/924	27.95



15.95

stainless steel



dark blue



stainless steel polished

Whistling Kettle Trend Color

Lightweight kettle with stainless steel body, heat-insulated folding handle with large filler opening and signal whistle. Material: stainless steel; Capacity: 2 l Dimensions (Hxø): 20.5x 18 cm; Pack size: 19 x 19 x 16 cm; Weight: 352 g

dark blue 310/563 15.95
green 310/564 15.95
stainless steel polished 310/898 15.95



43.90

Pan Set Pirate

Aluminium pan set with non-stick coating and removable handle for easy storage. Easy cooking and cleaning thanks to the non-stick coating. The set consists of 2 pans with ø 28 cm and ø 22 cm.

Suitable for gas, electric, halogen and ceramic hobs Packmaß: 32 x 30.9 x 7.4 cm; Weight: 1 kg 310/489 43.90



59.95 Folding safety catch for more stability!



Foldable Chair HighQ

The foldable chairs of the HighQ series are light and compact but still resilient. They are small when folded and thus still fit even if storage space is limited. Material: DuraDore® 2D Soft Touch;

Cover: 100 % PES polyester; Frame: aluminium round tube; max. load: 120 kg; Seat height: 42 cm; Dimensions (WxHxD): 58.5x94x60 cm; Pack size: 72 x 59 x 10 cm; Weight: 2.88 kg

Blueline	601/424	59.95
Greenline	601/425	59.95

Kids Chair HighQ

Just like the chairs and armchairs for adults, the kids' chairs of the Frankana Freiko HighQ series are very robust. Both the 2D mesh fabric for the seat surfaces and the 22 mm frame have been designed with durability in mind. A folding safety mechanism ensures sitting on a safe seat.

Material: DuraDore® 2D Soft Touch; Cover: 100 % PES polyester; Frame: aluminium round tube; max. load: 60 kg; Seat height: 36 cm; Dimensions (WxHxD): 37 x 67 x 35 cm; Pack size: 52 x 47 x 10 cm; Weight: 2.1 kg

Blueline	67 013	39.90
Greenline	67 012	39.90

Camping Chair HighQ Basic

Ergonomic sitting comfort and relaxation. Made of high-quality material and reinforced aluminium, this chair fulfils the highest standards of quality and comfort. Thanks to the continuous seat, the load is distributed optimally. A 7-position adjustable backrest, paired with ergonomically shaped padding and armrests, allows you to sit comfortably both at the dining table and when relaxing.

Cover: 100 % PES polyester; (Greyline: Cover: 100 % PES polyester); Frame: aluminium oval tube; max. load: 140 kg; Seat height: 47 cm; Backrest height 79 cm; Dimensions (WxHxD): 62.5 x 122 x 75 cm; Pack size: 106 x 63 x 13 cm; Weight: 5.2 kg

Blueline	601/411	99.95
Greenline	601/418	99.95
Blueline	601/120	99.95
Greyline	601/127	99.95



■ aluminium round tube
NEW

109.95



Camping Chair Zenith Ergofit

The new camping chair Zenith Ergofit is very flat when folded (8 cm) and easy to transport. A real lightweight at only 5.1 kg, it is the perfect companion on camping holidays. The height-adjustable, ergonomic headrest offers maximum comfort. The backrest and seat are also ergonomically shaped and the cover made of high-quality 2D mesh is particularly comfortable.

Cover: 100 % PES polyester; Frame: aluminium round tube; max. load: 140 kg; Backrest height 67 cm; Dimensions (WxHxD): 47 x 122 x 62 cm; Pack size: 100 x 62 x 8 cm; Weight: 5.1 kg

anthracite	601/578	109.95
light grey	601/579	109.95



■ aluminium square tube

NEW



Director's Chair Aravel Director

The robust and comfortable director's chair is equipped with a space-saving aluminium profile frame with powder coating. The armrests and seat are padded with 3Durafeel polyester fabric. The backrest can be folded and the chair is therefore very compact and easy to store when closed.

Colour: black; Cover: 100 % PES polyester; Frame: aluminium square tube; max. load: 120 kg; Backrest height 87,2 cm; Seat height: 48 cm; Dimensions (WxHxD): 45 x 87.2 x 35 cm; Pack size: 73.5 x 51 x 13.5 cm; Weight: 3.5 kg

601/607	71.90
----------------	--------------

NEW



dark grey, black

89.90

■ steel oval tube

Rocking Chair RoadTrip Rocker™

Folding rocking chair for outdoors. Innovative, portable and comfortable. Smooth rocking thanks to Spring-Action Rocking Technology™. Solid armrests and mesh backrest.

Cover: 100 % Ripstop polyester; Frame: steel oval tube; max. load: 110 kg; Backrest height 48 cm; Seat height: 50,8 cm Dimensions (WxHxD): 65.5 x 99 x 74.6 cm; Pack size: 113 x 24 x 18 cm; Weight: 5.8 kg

dark blue	601/611	89.90
dark grey, black	601/613	89.90
grey	601/612	89.90



aluminium round tube

from 85.95



incl. carry bag
weatherproof and heat-resistant

30 KG



Camping Table HighQ Blackline

With its aluminium frame, the table stands out as a lightweight with high stability. Large, ball-bearing foot plates ensure a secure stand even on uneven terrain. All four table legs are height-adjustable. The tabletop is weatherproof and heat-resistant.

Colour: grey; Frame: aluminium round tube; max. load: 30 kg; Height-adjustable: 55 – 72 cm

Dimensions (WxHxD)	Weight	Item no.	Price
80x72x60 cm	6.9 kg	601/116	85.95
115x72x70 cm	10 kg	601/117	119.95

EuroTrail

100 KG



79.95

aluminium round tube

Eurotrail Beach Chair Perez Beach Recycled

NEW

With a comfortable head cushion and a storage pocket with a small cooler on the back. Thanks to the carrying strap, it is easy to transport. You can stow snacks and drinks in the side pocket. The chair is equipped with a cover made of rPET and therefore sustainable.

Colour: blue; Cover: 100 % PES polyester; Frame: aluminium round tube; max. load: 100 kg; Dimensions (WxHxD): 62x75x55 cm; Pack size: 70 x 62 x 13 cm; Weight: 3.4 kg

601/605 79.95

can be folded compactly

BRUNER OUTDOOR IN MOTION

169.90



convenient plug-in system

30 KG

Rolling Table Accelerate Compack 4

The Accelerate Compack 4 is a further developed version of the successful Accelerate 4 rolling table. The frame design significantly reduces the pack size and meets the space-saving requirements of vans and minivans.

- Suitable for max. 4 people
- Aluminium frame with plug-in system
- Level compensation
- Gapless aluminium rolling tabletop
- Very compact pack size
- Incl. convenient storage net
- Incl. bag

Colour: aluminium, black; Frame: aluminium square tube; max. load: 30 kg; Dimensions (WxHxD): 120x80x71 cm; Pack size: 81 x 23 x 21 cm; Weight: 7.3 kg 601/541 169.90



120 KG

30 KG

aluminium oval tube

189.95

Chair/Table Set Compact

BRUNER OUTDOOR IN MOTION

The Compact chair and table set is perfect for campers who do not have a lot of space in their recreational vehicle. The two foldable chairs and the camping table are stored in a convenient bag, so that you do not have to do without important equipment. The set does not only provide a place to eat, but also a place where you can sit together comfortably.

Pack size: 106.5 x 62.5 x 22 cm; Colour: grey; Weight: 11 kg

2 chairs and 1 table in one bag!



Chair Skye 3D Compact

The space-saving aluminium foldable chair has a low, fixed backrest and loop legs. The cover is made of comfortable 3D fabric.

Max. load: 120 kg; dimensions (W x D x H): 65 x 57 x 95 cm; weight: 3.3 kg

Table Torun 2

Table with light, sturdy aluminium frame and folding legs made of painted steel. This version is compact and easy to transport. The durable, high-quality materials used guarantee high durability. Height-adjustable table legs.

Max. load: 30 kg; dimensions (W x D x H): 80 x 60 x 71 cm; weight: 4.2 kg 601/354 189.95



CRESPO

Furniture Set Valencia

The Crespo chair and table set Valencia was specially developed for smaller motorhomes and vans.

- 2 camping chairs with adjustable backrest and adjustable headrest.

Unpadded version: Type AL 213-C-40 (item no. 611/965). Max. load 110 kg. Padded version: AA/213-AEC (601/480). Max. load 110 kg.

- 2 separate footrests (only with the sets with footrests)

from 399.95

- 1 camping table, weatherproof and heat-resistant, size 101 x 65 cm. Type: AL/246-09G (item no. 601/023). Max. load 50 kg.
- 1 storage net 5 specially for the table. Type: R/248 (item no. 611/694)
- 1 carry bag for the complete set

unpadded | without footrest

Pack size: 102 x 71 x 17.5 cm; Weight: 13.6 kg 611/966 399.95

padded | without footrest

Pack size: 102 x 69 x 19 cm; Weight: 14 kg 601/139 479.95

unpadded | with footrest

Pack size: 103 x 68 x 20 cm; Weight: 17.5 kg 601/401 469.95



99.90



Two chairs, one bag, one price!

Folding Chair Set Frankana Freiko

The Frankana Freiko folding chair features a high-quality Demtex seat cover and a modern design. The highly convenient folding chair is equipped with a robust, powder-coated steel frame but is nevertheless pleasantly light. Its small pack size makes it the ideal companion for many occasions, be it camping or even a day trip by car. The chair is supplied as a set of two in a handy carry bag.

Colour: grey; Cover: 100 % PES polyester; Frame: steel oval tube; max. load: 110 kg; Seat height: 48 cm; Dimensions (WxHxD): 63x90x58 cm; Pack size: 100 x 33 x 21 cm; Weight: 4.6 kg

601/264 99.90

Disc-O-Bed

The single beds can easily be converted into a bunk bed or a bench. Max. load: 227 kg. Quick, easy and, above all, tool-free assembly. Incl. carry bag with shoulder strap for easy transport. Hygienic, as the mattresses can be washed. Plenty of storage space under the bed for shoes, bags, etc.

Cover: 100 % PES polyester, PVC coating; Frame: steel square tube; Weight: 14 kg



169.90

249.90

XLT Single Edition

Incl. carry bag with shoulder strap, organiser and Bunk-Kit.

Colour: anthracite; Lying area: 201 x 88 x 42 cm; Dimensions (LxWxH): 208x100x53 cm; Pack size: 100 x 52 x 11 cm

601/621 249.90

Single L

Incl. carry bag with shoulder strap.

Colour: black; Lying area: 201 x 70 x 42 cm; Dimensions (LxWxH): 208x82x51 cm; Pack size: 84 x 36 x 15 cm

601/622 169.90

From PET bottles to bel-sol chairs

The folding chairs by bel-sol are made of certified RPET material, which is obtained from recycled PET bottles and therefore reduces environmental pollution. At the same time, the chairs are very comfortable and durable and only have a small pack size. Perfect for weekend trips, days at the beach or your next camping holiday. Colour: grey; Cover: 100 % recycled PET



69.95



Folding Chair Mila

Elegant, comfortable and does not take up much space. An excellent choice for campers who want to have a reliable, environmentally friendly chair. Incl. transport bag. Made from 33 recycled PET bottles. max. load: 100 kg; Backrest height: 43,5 cm; Seat height: 48 cm; Dimensions (WxHxD): 50x91.5x42 cm; Pack size: 100 x 23 x 21 cm; Weight: 3.62 kg

601/516 69.95

Air Mattress ONE-Pad

Discover the exclusive ONE-Pad, an inflatable air mattress specially designed for Disc-O-Bed and a cost-effective alternative to the Disc-Pad. With an integrated pillow for extra comfort and a unique honeycomb structure for optimal pressure distribution, the ONE-Pad offers a premium sleeping experience. With a load capacity of 150 kg, the mattress is suitable for everyone. The 40D nylon makes the mat waterproof.

The special feature: The included carry bag is not only easy to transport, but also acts as a pump bag. This allows you to quickly and effortlessly inflate the mattress. A repair kit is also included.

Colour: anthracite; Pack size: 30 x 11 x 11 cm

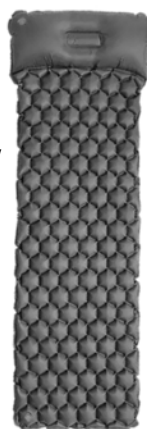

NEW

Dimensions (LxWxH): 190x68x5 cm; Weight: 600 g

612/137 39.90

Dimensions (LxWxH): 190x84x5 cm; Weight: 900 g

612/138 49.90

without illustration: Foot Pads

The Foot Pads can be easily attached to the round or straight frame of the Disc-O-Bed or Kid-O-Bunk. To do this, simply remove the rectangular rubber plugs from the straight frame and slide the foot pads onto it (pressing the foot pads slightly apart). The ribbed underside of the foot pads is designed to prevent slipping on smooth ground and to protect the groundsheet.

601/559 NEW 29.90

bel-sol®

aluminium oval tube



94.95



Director's Chair Benedikt

Director's chair with side table and cup holder.

Easy to transport thanks to carrying straps.

max. load: 120 kg; Backrest height: 65 cm

Seat height: 45 cm; Dimensions (WxHxD):

82x54x45 cm; Pack size: 85.5 x 57 x 19 cm;

Weight: 3.5 kg

601/572 94.95

from 39.90



Disc-O-Tent Mobile Tent

The robust, waterproof tent solution for every Disc-O-Bed single and bunk bed. Quick assembly thanks to pre-assembled telescopic poles and fabric, with rain cover, sun canopy, mosquito nets and openable sides for light and air circulation. The integrated groundsheet can be removed via a zip. Colour: dark grey, orange; Cover: 100 % PES polyester, with PU coating; Dimensions (WxHxD): 250x202x140 cm; Pack size: 103 x 26 x 23 cm; Weight: 6.1 kg

Scope of delivery: telescopic poles, sun canopy with poles, rain canopy (pre-assembled), ropes with holders, pegs, tie-down straps, groundsheet with zip

072/654 349.90

349.90



NEW



Refresh – and cool down!

Not only in the south, but also in summers in our latitudes – high temperatures are likely to be a big issue again this season.

Here we will tell you the best way to beat the heat, even in a van: Look for a shady spot if possible.

Van bodies are made of sheet metal, which heats up considerably during the day. If you park in the shade, you can also ventilate during the day if necessary. You can create your own shade with an awning (**from page 11**), a sun sail (**pages 7, 16**) or a sunblocker (**from page 17**). If possible, position your van close to a body of water. It is usually cooler here and there is often a refreshing breeze. Especially in the second half of the night, it's important to ventilate well! So open all windows and ensure a draught. Insects can be kept out by using appropriate protective

screens (**pages 48 – 49**), which also serve as privacy screens. Thermal mats (**page 54**), which can be for example attached to the windows from the inside using suction cups, provide an even better privacy and, above all, heat protection – they reflect the sun's rays and insulate against high outside temperatures.

If it is very warm, we recommend to move cooking to the outside of the vehicle. This is because cooking generates additional heat inside the vehicle. A barbecue (**pages 82 – 83**) is often on board or an additional camping cooker (**page 81**) is carried for cooking outdoors. Fortunately, there is also the option for an active air conditioning of the van via ventilation (**main catalogue pages 766 – 767**) or an air conditioning system. Frankana Freiko offers a large selection of different devices (**pages 104 – 106**) from well-known manufacturers. Air conditioning systems are powered by a compressor and

thus allow a really powerful cooling performance, which ensures pleasant temperatures that promote relaxed sleep even during the hottest nights. Modern air conditioning systems have a night mode, which also provides moderate cooling during sleeping hours if required. A power connection is recommended for operating a compressor air conditioning system. Please keep in mind that targeted ventilation before starting the air conditioning system reduces power consumption. When it's hot, don't forget to drink! A good active cool box (**pages 101 – 102**) or a refrigerator provides refreshing drinks. When it comes to fridges, the trend in van camping gravitates towards particularly compact and quiet compressor built-in fridges (**pages 103 – 104**), which have been designed for this vehicle class.



CoolFreeze CFF Freezer Boxes, 12 / 24 / 230 V

These surprisingly light compressor coolers are as uncomplicated as thermoelectric freezer boxes. They have been specifically developed for all cases in which a high mobility and frequent location changes are required. By using a more compact compressor, their weight has been reduced significantly.

A flexible placement of these boxes is also no problem: a super-slim design allows putting them in any corner. Both devices have a digital display and an interior LED lighting. They are ready to connect for 12/ 24 and 230 V. The CFF 12 has an integrated, 3-step battery guard. It is easy to transport thanks to a shoulder strap. The larger CFF 20 with detachable lid and sturdy carrying handles has a significantly larger storage capacity. Both devices provide excellent freezing and cooling performances, even at high outside temperatures.

Technical data:	CFF 12	CFF 20
Overall volume	13 l	21 l
Nominal voltage	12/24/230 V	12/24/230 V
Energy consumption	38 kWh/annum	40 kWh/annum
Dimensions (W x H x D)	56.2 x 38 x 23.5 cm	66 x 43 x 28.3 cm
Weight	9.4 kg	10.5 kg
Item no.	33 440	33 449
Price	499.00	529.00

DOMETIC

OUTDOOR

CFF 20



CFF 12



499.00

529.00

CFX3 35

799.00

CFX3 25



749.00

Can be controlled via Bluetooth or WiFi

CoolFreeze CFX3 Freezer Boxes, 12 / 24 / 100 – 240 V

The Dometic CFX3 series coolers set a new standard in mobile refrigeration and freezing. Fresh food and chilled drinks at any time – Dometic's market-leading VM303 cooling technology makes it possible. At the heart of the boxes are the speed-controlled compressors with optimised software for powerful refrigeration and deep-freezing with superior energy efficiency. The temperature can be set on the designed integrated TFT control panel or via CFX app from a smartphone or tablet PC via Bluetooth or WLAN. The CFX3 is equipped with a light and robust protective frame, making it ideal for outdoor use. Sturdy, spring-mounted aluminium handles make lifting and transporting easier.

Features:

- Refrigeration and deep-freezing down to -22 °C, regardless of the ambient temperature
- Speed-controlled high-performance compressor
- Fully insulated lid with aluminium hinge-integrated
- TFT control panel shows the operating status
- Removable wire baskets
- CFX Smartphone app for temperature control and recording of performance data

Technical data:	CFX3 25	CFX3 35
Net capacity	25 l	36 l
Nominal voltage	12/24/100-240 V	12/24/100-240 V
Energy consumption	44 kWh/annum	44 kWh/annum
Dimensions (W x H x D)	56.9 x 42 x 34.2 cm	69.4 x 40.7 x 39.8 cm
Weight	12.75 kg	16.9 kg
Item no.	33 362	33 363
Price	749.00	799.00

thermo-electrical

219.00



TropiCool Classic TCX, 12 / 24 / 230 V

The High-Tech boxes of the TropiCool Classic-Series come connection-ready for 12 / 24 and 230 V, with an automatic priority switch for power supply operation. For increased battery protection, 3 battery guards have been integrated. The boxes are equipped with the TC special electronics and a soft-touch operation panel. Cool up to 27 °C below ambient temperature and heat up to +65 °C – the temperature can be adjusted in-

dividually in 7 steps via the soft-touch operation panel: in cooling mode between 0 °C and + 16 °C and in the heater mode of +50 °C to +65 °C. The memory function saves the latest setting.

Technical data:

- Net capacity: 21 l
- Nominal voltage: 12 / 24 / 230 V
- Energy consumption: 73 kWh/annum
- Nominal capacity: 46 / 50 / 64 W
- Dimensions (W x H x T): 45 x 42 x 30.3 cm
- Weight: 7.8 kg

32 162

219.00



C36

849.00



799.00



C30



Truma Cooler, 12/ 24/ 100 – 240 V

The newest compressor coolers Truma Cooler cool or freeze reliably up to $-18\text{ }^{\circ}\text{C}$ even with high outside temperatures. They have been developed on the basis of decades of experience and tested in the Australian Outback under extreme conditions. The small and light Blue Compressor provides an extremely quiet operation. Thanks to the high-quality insulation and low power consumption, they cool efficiently while saving energy – a large-scale evaporator in the boxes ensures a homogeneous temperature distribution. The 3-step battery discharge protection preserves your vehicle battery. If at risk of overheating, the coolers automatically reduce their performance instead of switching off directly. Especially convenient is the possibility to control the coolers with the Truma Cooler App via smartphone and Bluetooth. Flexibly removable basket inserts, an LED interior illumination and a USB charging connection round off the overall picture.



Digital display with set/actual temperature display and control panel with turbo function



Integrated bottle opener on 2 sides



Reinforced corners and stainless steel hinges; when folded, the handle is flush with the side wall

Technical data:	C30	C36
Net capacity	30 l	35 l
Nominal voltage	12 / 24 / 100 – 240 V	12 / 24 / 100 – 240 V
Energy consumption	46 kWh/annum	42 kWh/annum
Dimensions (W x H x D)	61 x 42.2 x 34 cm	65.2 x 42.8 x 41.2 cm
Weight	17.5 kg	21.8 kg
Item no.	33 201	33 202
Price	799.00	849.00



The Truma Cooler App is now available in 9 languages.



from 549.00

Polarys Freeze DZ, 12 / 24 / 100 – 240 V

The perfect companion for all outdoor activities. Via the "Dual Zone", 2 temperature areas can be set separately. Operation is done via an LCD display with touchscreen, temperature setting is possible via the app. Frozen goods can be deep-frozen with up to $-20\text{ }^{\circ}\text{C}$. Thanks to a detachable battery (optional), the application without a power supply is no problem for up to 8 hours, a 3-step battery protection saves the battery. The high-quality compressor by LG ensures a quiet operation and a superior cooling performance. The boxes can be operated with a direct as well as alternating current. Other attractive features is a durable, shockproof construction and a changeable lid mount (rotatable lid) which enables a double-sided opening.

Technical data:	DZ35	DZ45
Net capacity	35 l	45 l
Nominal voltage	12 / 24 / 100 – 240 V **	12 / 24 / 100 – 240 V **
Nominal capacity	60 W	60 W
Power consumption		
12 V *	1.29 Ah / h	1.29 Ah / h
Dimensions (W x H x D)	64.7 x 44.1 x 40 cm	64.7 x 50.5 x 40 cm
Weight	15.6 kg	16.5 kg
Item no.	33 684	33 686
Price	549.00	599.00

* Average consumption at device's interior temperature = $5\text{ }^{\circ}\text{C}$ and ambient temperature = $32\text{ }^{\circ}\text{C}$

** 230 V via an external power supply included in delivery.



Changeable lid mount



Bottle opener on the side



167.90

Rechargeable Battery for Cooler Boxes Polarys Freeze DZ

The rechargeable lithium-ion battery E-Pack 15 provides the Polarys Freeze compressor coolers with mobile energy in case of not having an available charging current. Depending on the cooling level, the battery runs up to 8 hours.

33 689

167.90



Dometic RC 10.4M90, 12 V

Compressor refrigerator with a net capacity of 90 litres, a TFT-display and a door with double hinge. This versatile, 90-litre refrigerator for camping vans perfectly fit below the kitchen worktop. In limited space, control panel and/ or compressor can be detached and installed in a different place within the vehicle. The freezer compartment can be taken out; moreover, a powerful cooling aggregate is integrated, reliable even in hot climate zones. Via the self-explanatory TFT-control, the cooling temperature is easily regulated. The cooling aggregate can change nearly soundlessly into the night mode. A booster function for a particularly quick cooling can be activated.

Technical data:

Power supply 12 V, power consumption 3.6 Ah/ h, nominal power 56 W, net capacity 90 litres, dimensions W 42 x H 90 x D 45 cm, weight 21 kg. **33 541 1,459.00**

1,459.00

DOMETIC**OUTDOOR**

The control panel can be mounted anywhere you want – the appropriate installation kit is included.

NEW

The removable compressor can be mounted up to 1.5 m away from the refrigerator.



Double-sided door hinge for opening the door left or right



The patented freezer compartment is removable if more space is needed for fresh food.

THETFORD**T2138**

from 1,619.00

T2090

T2000, 12 V

The new T2000 series offers a wide choice of 12 V compressor refrigerators, developed with particular attention to changing customer needs: Compared to the absorption range in the same class, these units offer better performance, more usable volume and lower weight. At the same time, they operate quietly and energy-efficient. The door handle design integrates seamlessly into the modern exterior with its matt black look. The interior shows the Fresh Ice Grey design. The devices have a day mode and a very silent night mode.

Features

- Powerful with very good cooling capacity
- Exchangeable door hinge
- Door shape flat
- User friendly touch screen
- Automatic Temperature Control (ATC) with most efficient cooling power
- Regulated freezer compartment with 3 temperature settings (except T2090)
- Ready for CI-Bus connectivity
- 3 years manufacturer's warranty



User-friendly touchscreen

Technical data:	T2090	T2138
Net capacity	84 l	138 l
Net capacity freezer compartment	6,1 l	11,6 l
Nominal voltage	12 V	12 V
Ø Power consumption *	0.35 kWh / 24h	0.5 kWh / 24h
Dimensions (WxHxD)	41.8x97.5x48.6 cm	41.8x159.8x50.3 cm
Weight	21.1 kg	34.2 kg
Item no.	34 873	34 877
Price	1,619.00	2,439.00

* Average power consumption at ambient temperature = 25 °C

Compressor Refrigerators Cruise, 12/ 24 V

The refrigerators Cruise by Indel B are real high-performance refrigerators with compressor operation, which are comparable to household refrigerators. The energy consumption has been improved by optimising the cooling system, to ensure a high and constant operating performance at the same time. All devices are equipped with a freezer compartment, even the smallest versions.

Features:

- Available in 7 different sizes
- Easy-Fix system (except for Cruise 100) for quick installation
- Handy handle design
- Very small construction with the Cruise 86



Technical data:	Cruise 42	Cruise 49	Cruise 65	Cruise 85	Cruise 86	Cruise 100	Cruise 130
Net capacity	42 l	49 l	65 l	85 l	85 l	100 l	130 l
Net capacity freezer compartment	5 l	5 l	5 l	8 l	10 l	6 l	8 l
Nominal voltage	12 / 24 V	12 / 24 V	12 / 24 V	12 / 24 V	12 / 24 V	12 / 24 V	12 / 24 V
Ø Power consumption *	0.3 kWh / 24 h	0.28 kWh / 24 h	0.29 kWh / 24 h	0.39 kWh / 24 h	0.53 kWh / 24 h	0.4 kWh / 24 h	0.44 kWh / 24 h
Power consumption 12 V	40 W	45 W	60 W	60 W	50 W	60 W	60 W
Dimensions (W x H x D)	38 x 53 x 34.5 cm**	38 x 53 x 49.5 cm	45 x 53 x 51.1 cm	47.5 x 63.5 x 54.5 cm	38 x 86.2 x 51.1 cm	48.5 x 74.5 x 50 cm	52.5 x 75.5 x 55 cm
Weight	14.5 kg	16.5 kg	17.5 kg	21.5 kg	23 kg	22.5 kg	25.5 kg
Item no.	34 701	34 702	34 703	34 704	34 705	34 706	34 707
Price	829.00	835.00	879.00	889.00	945.00	965.00	995.00

* Operation with an ambient temperature of +16 °C to +38 °C

** plus 14.5 cm depth external compressor

from 1,289.00

without illustration:

Power Supply Smart Switch Adapter 230 V

For the trouble-free connection of the Cruise compressor refrigerators to the 230V power supply: with automatic priority function for network operation to spare the on-board battery.

34 759 149.00



Technical data:	Cruise DR49	Cruise DR65	Cruise DR85
Net capacity	49 l	65 l	85 l
Net capacity freezer compartment	10 l	14.5 l	11 l
Nominal voltage	12 / 24 V	12 / 24 V	12 / 24 V
Ø Power consumption *	0.31 kWh / 24 h	0.33 kWh / 24 h	0.36 kWh / 24 h
Power consumption 12 V	40 W	40 W	36 W
Dimensions (W x H x D)	38 x 52 x 50 cm	45 x 52.5 x 52.6 cm	47.5 x 63 x 55.1 cm
Weight	16 kg	18.1 kg	22.5 kg
Item no.	34 741	34 742	34 743
Price	1,289.00	1,475.00	1,490.00

* Operation with an ambient temperature of +16 °C to +38 °C

Air Conditioner Plein-Aircon, 12 V

Compared to systems that run on 230 V, this 12 V system does not require the installation of an inverter or power generator. Thanks to the soft start, the A/C system has a very low starting current. We also recommend the installation of a charging booster (for example, item no. 322/498, main catalogue page 557). The system is designed for roof installation and cools and dehumidifies the interior of motorhomes and vans with a total length of up to 6 metres. A timer and the remote control included in delivery additionally increase operating convenience. A battery monitor (e.g. item no. 322/162, main catalogue page 572) can be connected as an option.

2,279.00

Technical data:

- Nominal voltage 12 V
 - Nominal current 18 Ah (auto) / 48 Ah (max)
 - Cooling performance 1150 W
 - Cooling agent R134A
 - Dimensions air distributor (L x W x H) 60 x 53.3 x 5 cm
 - 2 air outlets (front and back)
 - Four-step ventilation (3 steps and automatic)
 - Moved air mass 350 m³/h
 - Roof thickness 30 – 70 mm
 - Cut-out dimensions 40 x 40 cm
 - Dimensions L 80 x W 72 x H 24.6 cm
 - Weight 28 kg
- 72 909 2,279.00**



without illustration: Mounting Frame

	Item no.	Price
Universal	72 907	99.00
Fiat Ducato 2006/07 – ...	72 908	99.00
VW Crafter / MAN TGE		
Built 2017 – ...	72 911	219.00



Roof Air Conditioners Dometic FreshJet FJX4 1700 / 2200

Next-generation roof air conditioner: fresh design, superior cooling performance, optimised airflow, remarkably quiet operation. The air distributor with LED lighting, which can be ordered separately, has an electronic touch control panel for convenient adjustment of temperature and airflow.

Technical data:	FJX4 1700	FJX4 2200
Recommended length of vehicle	< 6 m	< 7 m
Cooling capacity	1700 W / 5801 Btuh	2200 W / 7507 Btuh
Heat output	800 W	1000 W
Cut-out dimensions	40 x 40 cm	40 x 40 cm
Roof thickness	25 – 60 mm	25 – 60 mm
Nominal voltage	220 – 240 V	220 – 240 V
Nominal current cooling mode	3.6 A	4.8 A
Nominal current heating mode	5.2 A	5.2 A
Dimensions (LxWxH)	75.2x70.2x22.5 cm	75.2x70.2x22.5 cm
Dimensions Air distributor (LxWxH)	57.9x51.8x4.8 cm	57.9x51.8x4.8 cm
Weight	29 kg	30.4 kg

from 2,285.00

DOMETIC

OUTDOOR

Features:

- First-class cooling performance – the vehicles interior is cooled down in record time
- Less noisy in comparison to other roof air-conditioning systems on the market
- Excellent energy efficiency – less energy consumption
- CleanAir air cleaning system for fresh, clean air inside the vehicle

	Item no.	Price
FJX4 1700, white	73 404	2,285.00
FJX4 1700, black	73 405	2,285.00
FJX4 2200, white	73 407	2,385.00
FJX4 2200, black	73 408	2,385.00
air distributor	73 409	229.00

Roof Air Conditioner Dometic FreshJet FJX7 2200

This efficient and quiet 2200 W roof air conditioner impresses with its trendy design. The elegant roof unit with the exclusive LED light strip is an instant eye-catcher. Thanks to its modern compressor and heat pump technology, the FJX7 2200 has a lower power consumption while at the same time ensuring that the vehicle interior is cooled down in record time thanks to its first-class cooling performance. If required, it also features a heating function. The CleanAir technology effectively reduces bacteria and odours to leave the motorhome smelling fresh and clean. Thanks to the variably adjustable compressor speed, the FJX7 can work particularly quietly, yet always reliably maintaining the desired temperature in sleep mode. The eye-catching LED light curve and the aerodynamic housing give it an exclusive design.

The air distributor with remote control and touch operation panel has to be ordered separately.



Variable compressor speed, making it particularly quiet and efficient

Features:

- First-class cooling performance
- Rpm-controlled inverter compressor
- Reduced power consumption
- Low-noise operation
- Optional control via the Dometic smartphone app
- CleanAir air cleaning system for fresh, clean air inside the vehicle

NEW 2,699.00

Compatible with the Dometic smartphone app
Rpm-controlled inverter compressor



229.00

	Item no.	Price
FJX7 2200, white	73 411	2,699.00
FJX7 2200, black	73 412	2,699.00
air distributor	73 409	229.00

Technical data:	FJX7 2200
Recommended length of vehicle	< 7 m
Cooling capacity	2200 W / 7510 Btuh
Heat output	2000 W
Cut-out	40 x 40 cm
Roof thickness	25 – 60 mm
Nominal voltage	230 V
Nominal current cooling mode	5,9 A
Nominal current heating mode	3,7 A
Dimensions (LxWxH)	75.2x70.2x22.5 cm
Dimensions air distributor (LxWxH)	57.9x51.8x4.8 cm
Weight	29.5 kg



129.00

Adapter Frame Ducato

Specifically designed to install air conditioners on the profiled roof of the Fiat Ducato Type X250 and X290. The frame evens out beads on the roof, thus an optimal, even surface for better sealing of the air conditioner is created.

72 855 129.00

Air Conditioner EvaLIGHT plus

The proven air conditioner has been revised and equipped with a high-quality rotating display, a larger water tank of 1 litre capacity and a leak-proof water system. The EvaLIGHT plus reproduces the natural cooling effect created by evaporation and distributes the humidified air individually through the adjustable air outlet evenly and quietly in a cooling range of 3 to 4 m³. Advan-



tages besides the cooling effect: too dry room air is humidified and the air circulation through the unit filters dust particles from the air. The evaporation cartridge made of mineral fibre prevents deposits inside the device. One tank filling of 1 L cools for 6 to 8 hours. The EvaLIGHT plus can be operated at 100 – 240 V, or over 5 V via USB; dimensions W 18 x H 18.2 x D 18 cm.

179.90



evapolar

Colour	Item no.	Price
white	72 913	179.90
black	72 914	179.90
Spare Cartridge	72 916	36.90

NEW



Aventa compact

2,399.00
incl. air distributor

truma



Truma Aventa compact / Aventa compact plus

Refreshes reliably – light, quiet, powerful

The roof air conditioners Truma Aventa compact and Aventa compact plus are dimensioned to fit onto every vehicle roof. At the same time, they are the lightest and most quiet roof air conditioners available on the market. With their excellent cooling performance and individually adjustable air diffuser, they are the first choice for all recreational vehicles. Temperature and ventilation levels are remote controlled – or optionally with the Truma iNet X Panel (item no. 309/837, see main catalogue page 502) and the Truma iNet X app, or with the Truma CP plus (item no. 309/496, see main catalogue page 503) and the Truma app (the Truma CP plus and the Truma app only in combination with the Truma iNet box).

The Truma Combi with the operation panel Truma CP plus is installed in most vehicles. This makes it very easy to integrate the Aventa compact into the existing system. The automatic climate control is controlled either over the panel or the app.

Features:

- Compact: most lightweight roof air conditioner of its class on the market
- Universal: fitting onto all RV roofs
- Comfortable: very quiet operation
- Powerful: cools faster than all other roof A/Cs of its class
- Smart: app-controlled air conditioner and automatic climate control

Aventa compact plus

2,599.00
incl. air distributor



Technical data:	Aventa compact	Aventa compact plus
Recommended length of vehicle	< 6 m	< 7 m
Nominal voltage	230 V	230 V
Cooling capacity	1700 W	2200 W
Nominal current	2.8 A	4.4 A
Cut-out dimension	40 x 40 cm	40 x 40 cm
Dimensions (L x W x H)	78.5 x 56 x 26.5 cm	78.5 x 56 x 26.5 cm
Weight	27.5 kg	29.5 kg

	Colour	Item no.	Price
Aventa compact	white	72 833	2,170.00
Aventa compact	black	72 830	2,170.00
Aventa compact plus	white	72 836	2,370.00
Aventa compact plus	black	72 831	2,370.00

Air Diffuser small

The particularly compact air diffuser is equipped with two individually adjustable air outlets at the front and back. Dimensions: L 55.6 x W 49.6 x H 4.6 cm.

Please order air distributor separately

Colour	Item no.	Price
grey	72 840	229.00
cream	72 841	229.00



229.00

Accessories Aventa

1 | Sealing Frame

Is recommended for seamless sealing when installing into a 40 x 40 cm roof opening, for example into an already existing skylight opening.

72 844 55.00

2 | Adapter Frame Set

To complement the sealing frame (item no. 72 844) for van installation.

72 849 44.95





Maxview Scope 50

The anthracite Scope 50 by Maxview has been developed for caravans and campervans specifically. The very compact, equipped with a 50 cm-large satellite dish, fully-automatic satellite system can be applied where space on the roof is limited due to other installations. The following satellites are pre-programmed: Astra 1, Astra 2, Astra 3, Hotbird and Thor. Via the free app for Android and iOS devices, the Scope 50 can be controlled completely. Possibly required updates can be downloaded via the app. Optionally, the system can be controlled via the control unit included in delivery.

Performance features:

- Low, aerodynamic profile; height retracted just 18.5 cm
- Free app for satellite searching, selection, software update

Technical data:

- Power supply 12 V
- Automatic retraction of the antenna upon starting the motor
- Power consumption while searching max. 2 A
- Universal LNB
- Pre-programmed to 5 satellites
- Dish size 50 cm
- Dimensions antenna L 79 x W 50 x H 18.5 cm, control unit W 16.2 x H 3 x D 10 cm
- Weight antenna unit 13.5 kg

72 368 1,359.00



MAXVIEW

NEW

1,359.00



on exterior unit



KATHREIN

Digital Systems GmbH

CAP 650 GPS

The space-saving flat antenna with the pioneering CAP converter eliminates the need for a receiver and, connected to the WLAN-USB adapter UFZ 131 (item no. 71 462), allows for the streaming of television broadcasts.

"The Compact One"

- Incl. control unit CAP converter
- GPS receiver for quick alignment of the antenna in about 1 minute
- With flat antenna BAS 66
- Compact construction
- Software updates via satellite
- Twin LNB
- Weight 14.5 kg, installation height 21 cm

71 425 1,899.00



CAP 650 GPS

Reception areas

● Astra ● Hotbird

1,899.00



+ Accessories:

WiFi USB Adapter UFZ 132

Creates a WiFi hotspot with which TV and radio programmes can be streamed without an additional internet router to mobile devices (smartphones, tablets, etc.) The free Kathrein app "CAPcontrol" has to be installed.

71 459 39.90



39.90



Control Panel HDS 50 for CAP Converter

The desired satellite can be selected via LC display and push buttons. Lowering to parking position and other functions are available. Dimensions W 12.5 x D 2.5 x H 6.8 cm.

71 461 199.00



199.00

Roof Cable Routing HDZ 100

This protective housing is optimised for CAP systems. 2 coaxial and 1 power cable can be routed through or on the roof of the vehicle.

71 467 29.90

29.90





Cytrac[®]DX PREMIUM

At the heart of the Cytrac[®] DX PREMIUM are 1,016 coupled single antennas which are structured as a honeycomb. The signal accumulation is done by applying the latest mathematical calculating methods, thus providing a gigantic reception range.

Key features:

- One-cable technology
- App operation
- Automatic updates via app
- Patented reception technology for a gigantic range
- Space-saving installation onto nearly every vehicle roof
- Extremely low mounting height
- Fully automatic alignment and satellite finding
- High-quality processing of robust materials
- Robust, secure and weather-resistant construction
- Rotational-head-technology
- LEM technology: antenna searches in the latest adjusted tilting angle (reducing the searching time)
- Automatic satellite change upon programme change
- Automatic retraction when starting the engine
- 3 years manufacturer's warranty and reliable service
- Type-approval mark **(E1)** 10R - 068566

Scope of delivery:

- Motorised 12 / 24 volt outdoor unit, complete with antenna mirror and low-noise LNB
- Mounting material, control unit, instructions and connection cable

Subject to technical changes!



from 2.734.00
incl. TV set



Further details on the Oyster[®] Smart TV can be found on page 120.



Only approx. 14 cm

If you wish for a complete system from a single provider, you are best advised to choose the Premium version. This first-class system allows you to control all devices easily and conveniently with just one remote control.

The system consists of an exterior unit (base) as well as a separately ordered Oyster[®] Smart TV set.



Cytrac[®]DX Base

LNB	Item no.	Price	Smart TV	Energy efficiency class	Energy consumption	Item no.	Price
Single	71 324	2,195.00	Oyster 19.5"	E (Spectrum A ← G)	12 kWh / 1000h	70 201	539.00
Twin	71 325	2,380.00	Oyster 21.5"	E (Spectrum A ← G)	15 kWh / 1000h	70 202	599.00
			Oyster 24"	E (Spectrum A ← G)	17 kWh / 1000h	70 203	649.00
			Oyster 27"	E (Spectrum A ← G)	21 kWh / 1000h	70 204	749.00

Oyster[®] SMART TV

Reception range Cytrac[®] DX

- Astra 1
- Hotbird

Some programs have a short range. The respective satellite operators are responsible for the exact ranges.



Including app operation

The Cytrac[®] DX can now also be operated conveniently via the tenHaaft[®] App, which makes it very easy to install updates, so your system is always up to date with the latest software.

Suitable for Android and iOS.



Caratec CASAT

All Caratec satellite antennas of this series receive signals from Astra 1 and Hotbird upon pushing a button (Dual Sat). With the optional operation panel CASAT-102M, the reception of 12 satellites is even possible. Now, all versions are also available as a Smart version: in connection with the new Caratec TV set, steering for the desired satellite is very easy. The CASAT 500 series is the perfect solution for vehicles with little space on the roof, such as vans. The CASAT 850 series is highly suitable also for far journeys thanks to its large dish. All CASAT versions are quick and easy to install – just a cable to the interior has to be installed.

Technical data:

- Safety circuit and automatic retraction upon starting the motor
- Updates via microSD card
- Elevation/ inclination angle 15° – 75°
- Rotation angle 400°
- Frequency range 10.7 – 12.75 GHz
- Suitable for DVB-S SD and HD
- Suitable for DVB-SD and HD
- Operating temperature - 15 °C – + 45 °C
- Power supply 11 – 14 V
- Retrofittable for Twin operation
- Low mounting height 16 cm
- CASAT 500
Dish size 50 cm, dimensions L 63 x W 50 x H 16, weight 7.8 kg
- CASAT 600
Dish size 60 cm, dimensions L 73 x W 60 x H 16 cm, weight 8.2 kg

Scope of delivery:

- Exterior unit with detachable connection cable (3.5 m) and roof cable routing
- Dish made of aluminium with UV-resistant powder coating (pre-installed for all), control unit with operating buttons

Control Panel CASAT102M

Enables selection of 12 satellites at the push of a button. **71 108** **149.00**

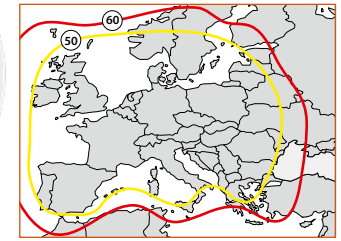

Reception areas Astra 1

- CASAT 500
- CASAT 600

Some programmes have a lower range.

from **1,299.00**

	Colour	Item no.	Price
CASAT 500D	white	71 103	1,299.00
CASAT 600D	white	71 104	1,399.00
CASAT 500S (Smart-D)	grey	71 115	1,399.00
CASAT 600S (Smart-D)	grey	71 116	1,499.00
CASAT 500S (Smart-D)	white	71 117	1,399.00
CASAT 600S (Smart-D)	white	71 118	1,499.00

Satellite systems with Smart-D:

In combination with a new, compatible Caratec TV set (see main catalogue page 826), controlling the desired satellite is very easy. The automatic alignment of the antenna to the desired satellite is possible with all TV devices with DiSEqC control. The opening and closing works by pushing a button on the control device.

from **1,488.00**



Reception area EasySat

- Astra 1 digital



MADE IN GERMANY



EasySat

A sat system where the name says it all. With the EasySat, the TV entertainment literally starts by pressing a button. The system simply has to be switched on via the one button operating device, aligning automatically, quickly and reliably to the ex works set satellite. As the EasySat works receiver-independently, every digital or HDTV receiver can be connected. The 45 cm offset mirror provides excellent reception in nearly all over Europe. Apart from the especially simple operation, the EasySat is characterised by its compact construction and its dimensions and weight, which have been reduced to a minimum.



Performance features:

- Micro-processor controlled searching procedure
- Fully automatic alignment without adjustment and positioning details
- Automatic antenna retraction upon starting the motor
- Robust exterior unit made of stainless materials (aluminium, V2A)
- Double protection against electronic overload
- 12-V operation
- No power consumption when deactivated
- Easy installation
- Universal LNB with 0.3 dB noise factor
- Installation height: 15.5 cm
- Weight: 6.5 kg.

white	72 477	1,488.00
black	72 479	1,498.00



1,299.00

Base shape: motorhome

Color: white



Option Router Set WebBooster

The roof module of the router set works as a roof cable routing for all satellite systems by Crystop. Just one hole has to be drilled into the vehicle's roof.



Further details on the router set WebBooster can be found on page 116.

Upon ordering together with a satellite system, please always state the base form and desired colour (black or white). **72 472** **1,299.00**



MEGASAT

Brillantes Fernsehen

from 1,199.00

Bluetooth



Reception areas
Caravanman
Kompakt 3

● Astra 1 ● Hotbird



Megasat Caravanman Kompakt 3

The Caravanman Kompakt 3 is the perfect fully automatic system for caravans, campers or motorhomes with a low mounting height. With its small mirror and swivelling area of just 77 cm, the antenna finds its place in every vehicle. Via the Bluetooth-compatible control unit, you can connect to every smartphone or tablet. With the free Megasat app – available for iOS and Android – the system can be controlled comfortably via Bluetooth. Moreover, future firmware updates are possible via this way, too. The Caravanman Kompakt 3 is pre-programmed for the following satellites: Astra 1, Astra 2, Astra 3, Astra 4, Hotbird, Thor, Hispasat, Türksat, Eutelsat 5 W, Eutelsat 9 B. With its low height of only 17 cm, it is one of the lowest components on the roof. Tanks to a new base, it can also be installed onto the refined Mobil-Kit (item no. 72 249), making it flexible in its use. Available as a Single or Twin version.

Technical data:

Dish size W 46 x H 32 cm, Universal LNB, frequency range 10.7 – 12.75 GHz, search angle 360°, alignment approx. 1 – 2 min., dimensions L 46 x W 46 x H 17 cm, weight approx. 5.1 kg.

Scope of delivery:

Exterior unit with connection cable, control unit (dimensions W 19.5 x H 3 x D 15 cm)

LNB	Colour	Item no.	Price
Single	white	72 208	1,199.00
Single	graphite grey	72 207	1,249.00
Twin	white	72 209	1,299.00



ALDEN

Onelight@ 60 EVO

Perfect for vans. The fully-automatic system offers a mounting height of just 15 cm and a weight of just 6.9 kg. It pleases with a modern design, which seamlessly integrates itself into the stylistic idiom of contemporary vehicles. It is available in the colours Ultrawhite and Platinum.

Key features:

- Low mounting height of just 15 cm
- Dish size 60
- Perforated offset dish
- Fully-automatic alignment and satellite finding
- Compact design with a high-quality finish
- Quick alignment
- Low power consumption
- Easy operation
- Dimensions L 68 x W 60 x H 15 cm
- Low weight 6.9 kg

Scope of delivery:

Aluminium mounting plate, exterior unit, S.S.C.® HD control unit, installation material, connection cable

Ultrawhite	70 460	1,589.00
Platinum	70 480	1,589.00



S.S.C.® HD control module

1,589.00



NEW



only 15 cm



Router and router set by Alden can be found on page 115.

LTEasy

Integrated LTE antenna in the roof cable routing

For all those putting emphasis on mobile phone connection apart from perfect satellite reception inside the motorhome or caravan, ALDEN has developed the LTE-Ready system. LTEasy is perfect for using the full range of functions of ALDEN Smart TVs.

Attention: The LTEasy stems is not available separately, but as part of the equipment of the antennas of the AS2@HD and the Onelight@ 60 HD EVO series.





from 799.00

ECO

Megasat Campingman Portable Eco Multi-Sat

With the multi-satellite-system, which is available in white, 5 satellites (Astra 1, Astra 2, Astra 3, Hotbird, Thor) can be selected. The change is conveniently done with pressing a button on the Bluetooth remote control included in delivery.

72 486 899.00

Megasat Campingman Portable Eco

The single-satellite system with parabolic antenna, which is available in white, does not need a separate control unit as the coaxial cable is directly connected to the television or the receiver. The coaxial cable also serves for the power supply – as soon as the TV or the receiver is on, the antenna starts and searches automatically for the satellite (pre-programmed for Astra 1). Thanks to the elegant plastic housing, the antenna is perfectly safe from weather effects and damage, and thanks to the 10 metre long cable, the exterior unit can be set up at any desired spot. For future transponder changes on the satellite, no antenna updates are required.

Technical data:

- Universal LNB
- Elevation/ inclining angle 23° – 43°
- Azimuth/ search angle 360°
- Power supply max. 300 mA
- Operating temperature -20 °C – +70 °C
- Dish size ø 38 cm
- Dimensions: ø 45 cm x H 43, weight 4.2 kg

Scope of delivery:

- Exterior unit
- 10 m coaxial cable

white
graphite grey



MEGASAT
Brillantes Fernsehen



Reception areas
Campingman
Portable Eco

● Astra 1
Campingman Por-
table Eco Multi-Sat
additional ● Hotbird

✓ Bluetooth Remote Control
for Eco-Multi-Sat



72 499 799.00
72 481 829.00

KATHREIN

Digital Systems GmbH



1,149.00

Sat-Set CAP 500M+

With the all-in-one package CAP 500M+, camping TV is made easy, portable, and thus, mobile and flexible. The core of the antenna set is the CAP converter which is connected in between the exterior unit and the TV set. Together with the USB WiFi adapter UFZ 132, live-streaming of TV and radio programmes to mobile devices such as tablets or smartphones is easily possible: after having installed the free CAPControl app onto the mobile device, the easy alignment can be started and consequent TV reception is under way.

71 154 1,149.00



Technical data:

- Alignment time typ. 90 s
- Max. power consumption 5.4 W (during alignment)
- Dimensions ø 45 x H 44 cm
- Weight 4.5 kg

Scope of delivery:

- Exterior unit CAP 500M
- CAP converter V2
- WiFi USB adapter UFZ 132
- Antenna cable, length 10 m
- Anti-theft protection



Reception area
● Astra 19,2 Ost



MAXVIEW



1,069.00

Maxview VuQube Auto II

The fully automatic and receiver-independent VuQube Auto II impresses with its extraordinary design, low weight, and compact shape. At the push of a button, it aligns with the desired satellite. It is pre-configured to Astra 1, Astra 2, Astra 3, and Hotbird. Thanks to powerful technology, it roughly matches the reception strength of a flat antenna. It is suitable for neighbouring holiday destinations as well as Great Britain and thanks to its Twin-LNB, provides the option to connect a 2nd, independent receiver. Possible uneven grounds are balanced out fully automatically by the VuQube Auto II. The system can also be installed firmly onto the vehicle's roof (requires the optional mounting sets item no. 72 316, 72 319).

Scope of Delivery:

0.5 m micro coaxial cable, 10 m coaxial cable, control unit, connecting cable (with plug) 12 V, mains adapter 230 V

72 318 1,069.00

Technical Data:

Twin Universal LNB, power supply 12 V, power consumption operation 0.6 amperes, azimuth 360°, dimensions W 49 x H 34 x D 43 cm, weight of the external unit 3.5 kg, dimensions control unit W 8.5 x H 2.5 x D 4 cm, no software update necessary, alarm-protected

without illustration: Roof Fastening Set

Necessary to firmly install VuQube Auto II on the roof of a caravan or motor home.

72 319 44.95

Quick-Out Bracket

The bracket functions following the principle of a ski binding and does not require any tools. The system can be kept in the bracket while driving.

72 316 169.00

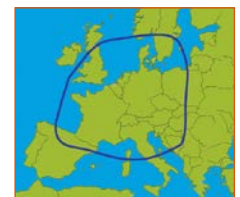

Reception area
VuQube Auto II
● Astra 1





Oyster® Access and EasyNet V1

Mobile internet just like at home – also while driving!

Adjusted to campers' needs

Like all products by ten Haaft, the new internet systems Oyster® Access and Oyster® EasyNet have been developed with the real needs of campers in mind. The benefit of such systems is that all devices within the vehicle can use a joint internet connection. This happens by providing a private dual band WiFi and a cable-bound LAN within the vehicle, resulting in 3 separate WiFi modules.

The connection between the Oyster® Access/ the Oyster® EasyNet and the internet can be established in 2 different ways:

- Via a LTE-connection over the mobile network with a SIM-card inserted by the customer
- Using a locally available, publicly accessible WiFi (e.g. on the campsite/ camping pitch or another public WiFi hotspots)

The tried and tested has been retained and yet everything is new

With the Oyster® Access as well as the Oyster® EasyNet, the system consists of an electronics unit installed in the vehicle and an exterior antenna mounted onto the vehicle's roof. The connection between the electronics unit and the exterior antenna is established via Oyster® Access and Oyster® EasyNet in the very classic manner via 4 high-quality, coaxial antenna cables. Different from the Oyster® Connect, the entire electronics is concentrated in a shared and compact housing in the vehicle's interior. This allows that the SIM card readers can be stored easily accessible at the front of the Oyster® Access and Oyster® EasyNet.

A new, active thermal management ensures an undisturbed operation, especially in warm environments.

Subject to technical changes!

NEW

Router Set Oyster® EasyNet

- Space-saving semi-sphere exterior antenna with integrated cable routing
- Compact antenna with 2 x LTE and 2 x WiFi MIMO
- 4 x low-loss antenna cables, firmly connected to the antenna, length 1.5 metre
- Thread length available with 27 or 45 mm
- Incl. electronics unit with router function

Thread length	Item no.	Price
27 mm	70 772	799.00
45 mm	70 775	799.00

Router Set Oyster® Access

- Full-size antenna with separate roof cable routing for the antenna cable
- 2 x LTE all-band antenna with Diversity technology
- 4 x WiFi antennas for 2.4 GHz and 5 GHz MIMO
- 4 x high-quality antenna cable with protective hose, mutually detachable, length 2 metre
- Incl. electronics unit with router function

70 779 879.00



Further details on the Oyster® Smart TV can be found on page 120.



799.00

879.00

Oyster® Access / Oyster Easy Net electronics unit

- 2.4 GHz/ 5 GHz dual band WiFi for the private network
- LAN-connection for the private network
- 2.4 GHz/ 5 GHz WiFi module for connection with external WiFi via exterior antenna
- LTE module for the use in the EMEA region
- 2 SIM card readers
- Optional CI/ LIN-BUS
- Optional CAN-BUS
- Temperature-controlled ventilator

2 x SIM card reader

Oyster® Smart TV

The Oyster® Connect System is perfectly aligned with the Oyster® Smart TV sets.

from 539.00



Smart TV	Item no.	Price
Oyster 19.5"	70 201	539.00
Oyster 21.5"	70 202	599.00
Oyster 24"	70 203	649.00
Oyster 27"	70 204	749.00



Innovative Mobile Technology

Oyster® Connect System

Mobile internet just like at home – also while driving!

With the Oyster® Connect, ten Haaft has developed a special antenna system for enhanced requirements: the mobile hotspot ensures a stable connection – even while driving. Comfortably surf in your motorhome, camping bus or caravan – and enjoy all advantages of a “mobile home network”. The connection is maintained regardless of the location, regardless of which network the external signal comes from – the registered end devices connect to their own hotspot automatically.

70 782 995.00



Oyster® Connect – Outdoor Unit



Oyster® Connect – Indoor Unit

The advantages at one glance

- Mounting the transmitter and receiver unit on the vehicle roof prevents attenuation loss
- Powerful WiFi antennas (2x2 MIMO)
- LTE Diversity antennas ITU region 1-3 for global reception
- One-time and easy set up of the “mobile home network”
- Free choice 2.4 GHz / 5 GHz in the WiFi network for indoor unit and outdoor unit
- supports all LTE-bands from 698 MHz to 3800 MHz
- Private LAN network enables WiFi network relief, not every Smart TV is WiFi-capable
- Aerodynamic body
- Easy installation and space-saving construction
- weather-resistant
- Comfortable operation

Scope of delivery:

- Oyster® Connect Outdoor Unit
- Oyster® Connect Indoor Unit
- Roof cable routing to the roof with 4 m data cable
- Power supply connection cable
- Oyster® Connect Indoor Unit
- Assembly plate

Subject to technical changes!

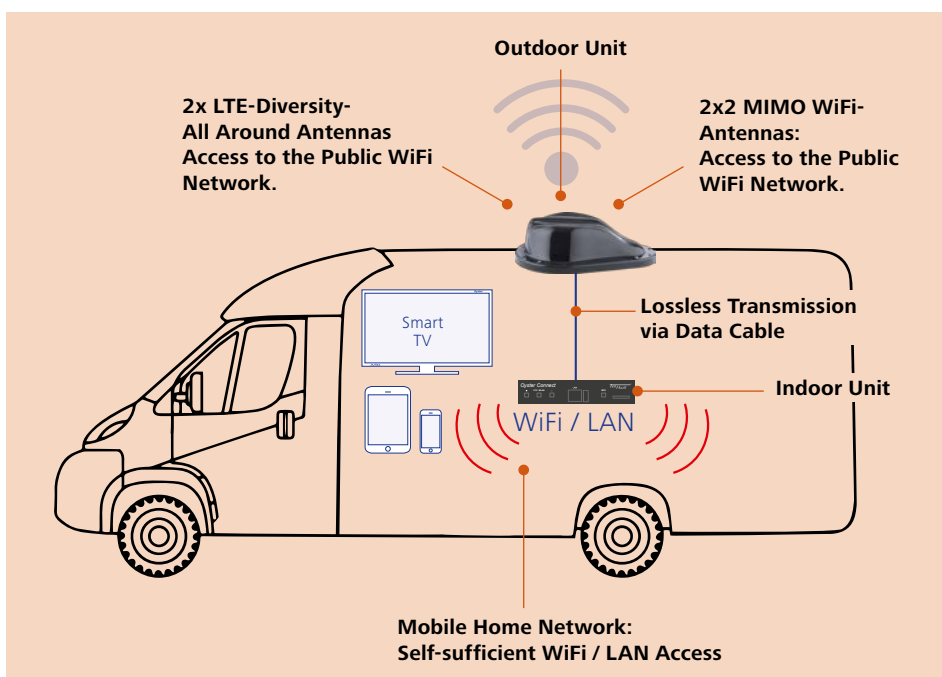

Further details on the Oyster® Smart TV can be found on page 120.

Oyster Smart TV

The Oyster® Connect System is perfectly aligned with the Oyster® Smart TV sets.

from **539.00**



SIM-card / Multi SIM-card

We recommend using a Multi SIM-card, which can be situated in the card reader in the outdoor unit. This is the best installation spot because there is no dampening of the signal through the chassis and thermal insulation glazing.

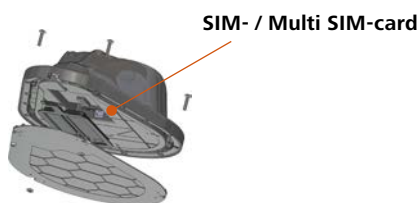

Smart TV	Item no.	Price
Oyster 19.5"	70 201	539.00
Oyster 21.5"	70 202	599.00
Oyster 24"	70 203	649.00
Oyster 27"	70 204	749.00



MEGASAT

Brillantes Fernsehen

Router Set Megasat Camper Connected 5G

An efficient exterior antenna as well as an equally efficient router – this is the new Megasat Camper Connected LTE-WiFi system. It amplifies the performance of the mobile signal to a maximum and provides uninterrupted internet reception. With the Camper Connected 5G, the wireless signal reaches the vehicle's interior intensified, thus providing best internet reception in high WiFi quality. The integrated GPS antenna allows to request the vehicle's position at any time. Moreover, the exterior antenna, which is installed via the detachable installation plate, for example onto the vehicle's roof, comes with a DAB+ antenna connector to make best reception for DAB+ devices possible.

Features multi-functional exterior antenna:

- LTE / 5G, 2.4 / 5.8 GHz WiFi, GPS, DAB+
- 4 connectors SMA Fakra Dimensions L 25.2 x W 9.5 x H 21.5 cm
- Weight approx. 750 g

NEW

Inclusive DAB+

Features router:

- LTE/ 5G
- WiFi 2.4/ 5.8 GHz
- GPS tracking
- 4 x 4 MIMO
- Connectors: 3 x LAN, 1 x WiFi, 1 USB 3.0, 8 antennas (SMA)
- 2 SIM card slot
- Reset button
- Data encryptions, firewall
- Dimensions W 12.4 x H 4.4 x D 11.3 cm
- Weight approx. 470 g

Scope of delivery:

- Roof antenna
- Router incl. antenna and power supply unit
- Connection cable 3 m for antenna and 4 m for router
- Installation plate and roof cable routing

70 752 899.00



MAXVIEW

Router Set Maxview Roam 5G Campervan

The Roam Campervan 5G is equipped with a powerful LTE/ 5G high-performance router with 2 antennas. It is the ultimate solution for a very intense internet use with the latest 5G technology. Via the free ROAM app for Android and iOS operating systems, the router is easy and quick to configure.

Scope of delivery:

- 5G-capable, 360° round antenna (W 6 x H 6.5 x D 18 cm, weight 470 g)
- CAT20 router with 2 WiFi antennas (W 13.2 x H 11 x D 4.4 cm, weight 577 g)
- WiFi 5: 2.4 GHz and 5 GHz
- 12 V connection cable
- Wall mount for the router
- Coaxial cable (length 80 cm) with plugs
- Ethernet cable
- Mounting banjo screw

white 70 706 1,179.00
 anthracite 70 707 1,179.00



NEW

1,179.00



ROAM 5G CAMPERVAN

There are 2 different mounting options available:

Directly onto the roof

The cables are led directly below the antenna through the connecting banjo bolt into the vehicle interior. A powerful self-adhesive seal prevents moisture ingress and provides additional support on the roof. All the necessary components are included in the scope of delivery.

64.90



With optional roof mount

The aluminium mount has been developed and produced for the Roam campervan antenna in particular. The set includes a 2 m extension cable roof bushing, cable fixing clamps and screws.

white 71 192 64.90
 anthracite 71 193 64.90

+ Accessories

Coaxial Extension Cable

	Item no.	Price
2 x 1 m	71 206	16.95
2 x 2 m	71 207	21.95
2 x 3 m	71 208	24.95
2 x 5 m	71 209	31.95



Maxview Roam App



Router Set Caratec Electronics CET305R

Reliable and ultra-fast internet inside the motor-home: no matter if its WiFi from the campsite, LTE or 5G. With the CET305R, ultra-fast and stable internet to work or surf and for the smart TV is always at hand. The powerful LTE/ 5G WiFi router ensures, together with the exterior antenna, a reliably stable internet connection with a high data flow rate. The telephone module provides 2 SIM card slots for, for example, one main card and a local card of your holiday destination. The WiFi module provides, via the flat and powerful exterior antenna, reception of external signals such as WiFi from the campsite. The interior antenna is used to connect devices, such as smartphones, tablets, PCs or a Smart TV. Thanks to the clearly structured web application, the router is very easy to control.

Features exterior antenna

- LTE/ 5G reception (4 x 4 MIMO), WiFi reception
- Weatherproof
- With bracket
- Dimensions
W 19.9 x H 5.3 x D 16.7 cm (height with bracket 10.3 cm)
- Weight 628 g



Features router

- 2 SIM card slots
- 5 LAN ports
- USB port
- Antenna ports 4 x 5G/ LTE, 2 x WiFi, 1 x GNSS
- 5G up to 3.3 Gbps (4 x 4 MIMO)
- LTE Cat 20 up to 2.0 Gbps
- WiFi 2.4 GHz and 5 GHz, 802.11b/g/n/ac Wave 2 (WiFi 5)
- Dimensions
W 13.2 x H 4.4 x D 9.5 cm
- Weight 533 g

Scope of delivery:

- Router
- Exterior antenna with bracket
- Roof cable routing
- WiFi interior antenna
- 12 V connection cable
- On-/ off-switch

70 745 1,199.00

■ Full 5G reception

caratec®

Exterior antenna
CET305R 5G



5G / WiFi
router



1,199.00

ALDEN

Router Set ALDEN I-NET CAMP 512

The I-NET Camp 512 set with a portable high-performance router and LTE/ 5G antenna has been specifically designed for travelling within and outside of Europe and is adapted to the needs of travellers.

Features I-NET EVO 5G panoramic antenna

- LTE/ 5G
- 4x LTE MIMO, 2x WiFi MIMO
- Easy to install with integrated cables
- Dimensions L 18.9 x W 18.2 x H 8.5 cm
- Weight 600 g

NEW

Scope of delivery

- 5G antenna
- Router I-NET CAMP 512
- SIM adapter kit
- Ethernet cable 1.5 m
- 12 V connection cable
- 2 WiFi SMA antennae, 2 mobile SMA antennae
- Antenna mounting set

70 729 1,199.00

Exterior antenna

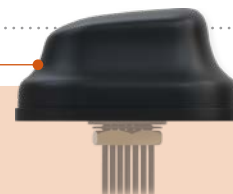

1,199.00

■ 5G

LTE /5G /
WiFi router



NEW

899.00



Router ALDEN I-NET 512

Do you want to upgrade your antenna system to the 5G standard and do you already have a 5G-capable roof antenna installed? With the ALDEN I-NET 512 router this is no problem! It effortlessly communicates with all standard 5G-antennas.

The I-NET 512 router of the category 20 (CAT 20) is equipped with a processor of the latest generation and offers the perfect solution for quick, mobile internet in vehicles. Enjoy a seamlessly connected travelling experience in campers, vans or caravans and use with up to 150 connected devices the mobile and/ or WiFi internet connection.

Features ALDEN I-NET 512 Router:

- LTE
- CAT20
- up to 3.3 Gbps
- WiFi 2.4 GHz/ 5.0 GHz
- Connection of up to 150 devices
- Mobil networks 5G, 4G, 3G
- Easy to install via WEB app
- 2 SIM card slots, 4 x LAN, 1 x WiFi
- Inputs 4 x SMA for LTE/ 5G, 2 x WiFi, 1 x GPS
- Power supply 12 V (9 -50 V)
- Dimensions L 13.2 x W 9.5 x H 4.4 cm
- Weight 533 g

70 725 899.00



KATHREIN

Digital Systems GmbH

NEW

1,149.00

Exterior antenna 5G available in black or white

Full 5G-reception

Web interface

5G / WiFi router

FindMyCaravan function
With this function, you can have the GPS data of your caravan or camper send to you via SMS anytime.

Kathrein CAR 5G

Router set for demanding applications: the roof antenna is made for the 5G standard and can process large data volumes. However, it can also receive LTE signals. Besides WiFi, the router processes the full 5G capacity.

Features exterior antenna:

- LTE-/ 5G-reception
- 4 5G, 1 GPS and 2 WiFi antennas
- Dimensions W 19.9 x H 5.4 x D 16.7 cm
- Weight approx. 550 g

Features LTE/ WiFi router:

- 5G reception (MIMO), LTE or WiFi
- 2 SIM card slots of the use of different networks
- 7 antenna, 4 ethernet and 1 USB port
- German service hotline, made in the EU
- Supply 12/ 230 V
- LTE router W 10.9 13.2 x H 4.5 D 9.6 cm
- Weight 533 g

white	70 740	1,149.00
black	70 744	1,149.00

Router Set alphasronics Stream 5G Pro

The alphasronics STREAM 5G Pro set offers the current maximum download via 1 SIM-card. An ideal solution for users which like to have a large reserve in terms of bandwidth. The router is made for 4G- and 5G-networks and in the 5G-segment (CAT 20) can download data with up to 3,000 MBit/s. Thanks to 2 SIM-slots with automatic SIM-card recognition, different SIM-cards can be used. Intuitive operation via the alphasronics web app.

Features exterior antenna:

- MIMO-version for 5G support
- Connections: 4 x LTE, 1 x GPS, 2 x WiFi
- Dimensions W 17.5 x H 5.7 x D 11.8 cm
- UV- and weather-resistant, IP67 certified
- Weight: 350 g

alphatronics

Features router:

- 5G router (also supports LTE)
- Speed of up to 3,000 MBit/s
- Automotive-certified product
- 2 SIM card slots
- Dimensions B 9.5 x H 4.4 x D 13.2 cm
- Weight 530 g

Scope of delivery:

- 5G router
- Exterior antenna
- 12 V connection cable, 230 V power supply
- Mounting material

Exterior antenna

NEW

1,149.00

LTE / 5G / WiFi router
Stream 5G Pro

NEW

1,299.00

Exterior antenna

5G / WiFi router

Router Set Crystop WebBooster

The roof module with integrated WiFi- and radio antennas for LTE/ 5G combined with the 5G router by Crystop creates the perfect tandem to receive multimedia data. The roof module is available as a versions specifically for vans, which is adjusted to the trapeze roof shape of this vehicle type. Thanks to its powerful layout, the router can receive LTE, 5G as well as WiFi signals. In the interior of the recreational vehicle, WiFi via a router functioning as an Access Point (hotspot) is set up. The CAT20 router is equipped with 2 SIM-card slots; one SIM-card with 5G data volume valid for 2 years is included in the price and can be requested at Crystop (see instruction manual).

CRYSTOP

Features roof module:

- 1 WiFi antenna, 4 LTE/ 5G antennas
- Dimensions L 27 x W 9.5 x H 10 cm
- Weight 410 g

Features router Crystop 5G:

- LTE / 5G
- CAT20
- WiFi
- 2 SIM-card slots, 4 x LAN, 1 x WiFi
- Dimensions L 13.2 x B 9.51 x H 4.42 cm
- Weight 533 g

Version	Colour	Item no.	Price
Standard	white	70 721	1,299.00
Standard	black	70 722	1,299.00
Van	white	70 723	1,299.00
Van	black	70 724	1,299.00



NEW



from 579.00

alphantronics TV SLA-Line

Experience first-class sound thanks to the integrated soundbar and the loudspeakers radiating towards the front with the SLA line by alphantronics. Highlight is the operating system webOS Hub in the next configuration level; among it, PVR recordings, Timeshift, Apple AirPlay and HomeKit as well as the integration of the Matter Smart Home standards. Updates are provided regularly via OTA (Over-The-Air). The SLA line is available with display sizes 22", 24" and 27". Thanks to the "Magic Remote" remote control included in delivery, inputs can be made via AirMouse (digital cursor and movement of the remote control) as well as by voice. Equipped with a triple tuner (DVB-S/S2, DVB-T/T2, DVB-C), HbbTV, CI+, DVD player, 2 x USB port, 2 x HDMI port, Bluetooth® 5.0 as well as a light wave port (SPIDF/ Toslink), enabling the connection of digital soundbars or hearing aids.

Features:

Power supply 12/ 24 V (230 V via optional mains unit), Full HD (22", 24", 27"), UDH (4K) (32"), Dual Band WiFi (2.4 GHz/ 5 GHz), Bluetooth 5.0, 3 years manufacturer's warranty.

In-/ Outputs:

Antenna (F-socket + IEC-socket), 2 x HDMI, 2 x USB, SPIDF (optical), headphones, AV in, RJ45 (LAN), Common Interface (CI+).

powered by
webOS Hub

DVD



WLAN



Bluetooth



100 % pixel-error-free



Technical data:	SLA-22 DW	SLA-24 DW	SLA-27 DW
Energy efficiency class	E (Spectrum A ← G)	E (Spectrum A ← G)	E (Spectrum A ← G)
Energy consumption	15 kWh / 1000h	18 kWh / 1000h	21 kWh / 1000h
Screen size	22" (55 cm)	24" (60 cm)	27" (68.5 cm)
Resolution	1920 x 1080 pixels	1920 x 1080 pixels	1920 x 1080 pixels
Brightness	350 cd/m2	300 cd/m2	250 cd/m2
Contrast ratio	1000:1	1000:1	1000:1
Viewing angle	H 178° V 178°	H 178° V 178°	H 178° V 178°
Music power	2 x 5 W	2 x 5 W	2 x 5 W
Dimensions (W x H x D)	50.2 x 33 x 5 cm	55.2 x 36 x 5 cm	62.2 x 39.5 x 5.5 cm
Weight	3.4 kg	4.1 kg	5.4 kg
Item no.	70 286	70 287	70 288
Price	579.00	659.00	699.00



Stand

For sizes up to 27" 70 227 24.00

w/o illu. Power Supply 230 V

For sizes	Item no.	Price
up to 24"	70 252	39.00
27"	70 253	39.00

alphantronics



149.00

Bluetooth

alphantronicsSound 5 – Bluetooth Earphones

The over-ear earphones with Bluetooth 5.0 technology is available with ANC (Active Noise Cancellation) and runs up to 15 hours. With a reception range of up to 10 m, it persuades with a detailed sound reproduction and comfortable wearing. Loaded via USB, volume control at the headphone. Storage bag included in delivery.

70 109 149.00

Soundbar alphantronicsSound S-40 Mobile

Developed for universal application connected to the TV, you experience compelling Home Cinema sound in the motorhome thanks to the application of 4 x 10 W full range stereo loudspeakers and an adapted audio software. Thanks to the elaborate support system, the S-40 Mobile is detached from the TV in no time and can be used portably, e.g. in the awning. The integrated battery allows up to 12 hours running time. Thanks to Bluetooth 5.0 (AptX Low Latency), music streaming is as easy as pie. A holder for TV and the remote control are included in delivery. Dimensions W 46 x H 5.6 x D 5.1 cm, weight 1.1 kg.

Features:

Bluetooth 5.0 AptX, 4 x 10 W (RMS) with bass-reflex, HDMI ARC connection TV, AUX-input (3.5 mm jack), USB-C charging connection, integrated battery (up to 12 hours play time), on/off switch, volume control, power supply via USB-C.

	Item no.	Price
without DAB+ Tuner	70 104	249.00
with DAB+ Tuner	70 105	319.00

249.00

Bluetooth

319.00

DAB+ / FM



2.4 GHz radio receiver 39.90

alphantronics Keyboard T1

Wireless touch pad keyboard with USB 2.0 interface for connection, Plug & Play. It has a large touchpad for comfortable operation of your SMART-TV.

70 147 39.90



TFT LED Flat Screen TV Royal Line IV Smart

The Smart version distinguishes itself from the standard series through Bluetooth, LAN and WiFi interfaces. The Smart TV without DVD drive comes with an internet browser and many pre-installed apps on the basis of an Android 11 operating system with access to different media portals. Additionally, further apps can be installed via the integrated app store. The Bluetooth 4.2 port makes the wireless sound replay via Bluetooth audio devices, such as headphones and loudspeakers, possible.

from **369.00**

NEW



Technical data:	RL IV 19 Smart	RL IV 22 Smart	RL IV 24 Smart
Energy efficiency class	E (Spectrum A ← G)	E (Spectrum A ← G)	E (Spectrum A ← G)
Energy consumption	12 kWh / 1000h	14 kWh / 1000h	17 kWh / 1000h
Screen size	18.5" (47 cm)	21.5" (54.6 cm)	23.8" (60,5 cm)
Resolution	1366 x 768 pixels	1920 x 1080 pixels	1920 x 1080 pixels
Brightness	250 cd/m ²	250 cd/m ²	250 cd/m ²
Contrast ratio	1000:1	3000:1	3000:1
Viewing angle	H 178° V 178°	H 178° V 178°	H 178° V 178°
Music power	2 x 5 W	2 x 5 W	2 x 5 W
Dimensions without stand (W x H x D)	43.6 x 25.9 x 4.9 cm	50.1 x 29.8 x 4.9 cm	55.1 x 32.6 x 4.9 cm
Weight	2.3 kg	2.4 kg	2.8 kg
Item no.	70 007	70 011	70 027
Price	369.00	399.00	429.00

Accessories



Stand

Suitable for Royal Line III and IV Smart.

For	Item no.	Price
RL III + IV 19"	70 055	14.90
RL III + IV 22" / 24"	70 057	14.90

Soundbar I

Two broadband speakers with together 12 W music performance, integrated into an optically appealing housing improving the sound of your camping television significantly. Power supply and audio transmission via USB and headphone input to the TV. The volume is regulated via a rotary knob (including on-/off-switch) on the soundbar. Optionally, the soundbar can be mounted directly below the TV – a suitable bracket is included in delivery. Dimensions W 40 x H 6 x D 5.5 cm, weight 410 g.

49.90



79.90



Bluetooth

70 056 49.90

Soundbar Klangwunder V

Two broadband loudspeakers with 30 W music power altogether change audio signals via Bluetooth into a rich stereo sound. The soundbar can be mounted onto Megaset TV-sets easily. All standard functions can be controlled by the remote control included in delivery.

Features:

Power supply 12/ 230 V, Bluetooth 4.0, USB port, audio input, 3.5 mm jack, MP3 mode, dimensions: W 41 x D 6 x H 6 cm, weight: approx. 800 g.

70 058 79.90



115.00

Wall Bracket Sky 1

The front part contains a ball joint, which allows to turn the flat screen freely. Delivery includes 1 holding plate for VESA norm 75 and 100, which is simply put on the holder and locked with a wing nut. Thus the displays can be easily removed and stowed away while not in use.

Technical data:

- Swivel Joints: 1
- max. Wall distance: 11.5 cm
- Max. load: 8 kg

72 641 115.00



from **242.00**

Wall Bracket Sky 10N

Double joint bracket with locking mechanism and quick-release base. Suitable for all TV devices with VESA norm 75 and 100.

Length	Max. load	Weight	Item no.	Price
48 cm	12 kg	2.1 kg	72 644	242.00
58 cm	10 kg	2.2 kg	72 639	244.00
68 cm	8.5 kg	2.2 kg	72 640	257.00
68 cm with Bowden cable	8.5 kg	2.7 kg	72 646	308.00
78 cm	7.5 kg	2.3 kg	72 645	263.00



Item no. 72 646 with Bowden cable for easier unlocking



298.00

Wall Bracket Sky 20W

Console extension with infinitely adjustable swivelling mechanism (up to 180 °) and a tilt angle that is adjustable by ±10°. The mount can be installed either on the left or the right side. Suitable for all TV devices with VESA norm 75 and 100. Max. extension: 73.8 cm, load capacity: max. 6.5 kg, dimensions: L 39/ 73.8 x D 5.7 x H 24.4 cm.

72 658 298.00



TFT-LED Flat Screen TV with webOS Caratec Vision Smart-TV

The 22", 24" and 27" devices of the Exclusive Smart TV series are almost frameless. The picture of the wide-angle panel goes almost to the edge, making the devices extremely compact and particularly elegant. They are equipped with DVB-T2 and DVB-S2 receivers, the webOS Smart TV with countless apps for streaming services as well as protection against over- and undervoltage. A Bluetooth transmitter is integrated to connect external Bluetooth speakers. The operation of the devices is done easily via voice or Magic Remote. The operating instructions included in the TV saves from annoying searches.

from 449.00



Features:

12 V power supply (230 V via optional mains adapter), 16.7 million display colours, colour video system PAL/NTSC/SECAM, tele text, VESA standard 100, mains on-/ off-switch.

In/ Outputs:

Antenna (DVB-S2, DVB-T2), 3 x HDMI, AV (Adapter), audio, digital audio, headphones, 2 x USB, CI+ (Common Interface), S/PDIF (optical), RJ45 ethernet (LAN).

NEW

Technical data:	CAV222E-S	CAV242E-S	CAV272E-S
Energy efficiency class	E (Spectrum A ← G)	E (Spectrum A ← G)	E (Spectrum A ← G)
Energy consumption	15 kWh / 1000h	15 kWh / 1000h	21 kWh / 1000h
Screen size	21.5" (55 cm)	23.6" (60 cm)	27" (69 cm)
Resolution	1920 x 1080 pixels	1920 x 1080 pixels	1920 x 1080 pixels
Brightness	220 cd/m2	220 cd/m2	220 cd/m2
Contrast ratio	3000:1	3000:1	3000:1
Viewing angle	H 178° V 178°	H 178° V 178°	H 178° V 178°
Music power	2 x 5 W	2 x 5 W	2 x 8 W
Dimensions (WxHxD)	49.7 x 29.1 x 4.4 cm	54.2 x 31.9 x 4.4 cm	61.7 x 36.2 x 4.5 cm
Weight	2.5 kg	2.8 kg	3.8 kg
Item no.	70 070	70 071	70 077
Price	449.00	499.00	549.00

without illustration:
Power Supply 230 V

powered by
webOS Hub

For	Item no.	Price
CAV222E-S, CAV242E-S	70 090	39.90
CAV272E-S	70 095	39.90

without illustration: Stand

For	Item no.	Price
CAV222E-S, CAV242E-S	70 101	24.90
CAV272E-S	70 103	24.90

Lateral Extension Flex CFA102L

Extension suitable for side mounting in and on cabinets, which can be easily locked and unlocked by means of Push Lock and a spring steel bracket. Its retaining plate can be rotated 190°, easily adjusting it to the desired position. The extension can be pulled out by max. 47 cm, rail length extended approx. 83.5 cm. Made of aluminium, load capacity 6.5 kg. Dimensions approx. W 41 x D 4.4 x H 15.5 cm, weight 2.2 kg.

72 659 209.00**209.00****89.00**

Caratec Soundbar CAS102

Clear soundbar with a strong sound in an elegant design. Including all connections to the headphones plug and 12 V power supply. A number of 4 operating elements are available on the side: on/ off, increase/ decrease volume, mute. Thanks to the adjustable angle brackets included in delivery, which are simply mounted in between the TV set and the TV mount, the CAS102 is suitable for most TV sets. Dimensions: W 48 x H 6 x D 6 cm, weight: 920 g (incl. bracket and cable 1.36 kg).

70 100 89.00

Sound System Caratec CAS101BT

The ideal solution to easily and almost invisibly have a better sound for TV and smartphone in a motorhome or trailer. The compact 4 channel amplifier is connected with the earphone jack of the television. The integrated Bluetooth unit can be used as a different source. Herewith, the music coming from the smartphone can easily be streamed. 2 Caratec Exciter CAE70 are used as

Neck Loudspeaker Caratec Audio BeatSnake

An alternative for music and television entertainment in the motorhome is the Caratec BeatSnake. Simply put it around your neck and go. Thanks to the direct alignment of the loudspeakers towards the ears, perfect audibility is ensured without disrupting fellow passengers. Nonetheless, a conversation with the BeatSnake, in contrast to headphones, is possible without any problems. BeatSnake is perfectly suitable for the combination with the Caratec Smart TVs. The pairing is done via Bluetooth and as a result, is

**79.90****NEW**

also not a problem with other devices such as smartphone or tablet. Two BeatSnakes can be connected with each other. Bluetooth 5.0, frequency response from 68 Hz to 18 kHz, wireless range approx.

10 m (open field), battery life of up to 9 hours, battery charging time approx. 3 hours, battery capacity 800 mAh, charging voltage/power 5V / 0.5 A, charging connection USB-C, cable included in delivery, dimensions W 24.5 x D 20.5 x H 4.5 cm, weight 300 g.

70 107 79.90

sound converters. They are mounted invisibly beneath the furniture and create a pleasant sound. The set can optionally be extended by 2 more CAE70.

70 096 119.00

Exciter Caratec CAE70

One piece to extend CAS101BT to a maximum of 4 exciters.

70 097 19.90**Bluetooth****119.00**

**tenHaaft**[®]

Innovative Mobile Technology

NEW from 539.00**Oyster[®] SMART TV****TFT LED Flat Screen TV Oyster[®] Smart TV****Features:**

- High-end device with ultra-flat design
- Integrated 2.4 GHz and 5 GHz WiFi
- WiFi set-up with WPS (compatible WiFi sources required, e.g. Oyster[®] Connect, Oyster[®] Access and Oyster[®] EasyNet)
- Bluetooth 5.1
- Integrated tuner for DVB-S2, DVB-T2 HD/H.265
- VIDAA operating system with full access to a.l apps in the Google Play Store like, for example, streaming services and web browser
- HbbTV ("hybrid broadcast broadband television")
- Multiple sender favourites' lists (e.g. for Germany, Austria, Switzerland, etc.)
- WIDI/ Miracast
- OTA (Over-The-Air-Update – software updates via the internet)
- Connectivity via USB 2.0 and HDMI
- Freely nameable signal inputs
- Universal installation with VESA standard mount
- System remote control: just one remote control for the satellite system and the Oyster[®] Smart TV set
- EPG electronic programme guide with 7-day-preview
- ON-SCREEN display for supply voltage
- "Only audio"-function
- Barrier-free use
- Module slot CI / CI+
- Power consumption in standby < 0.5 Watt
- Stable construction for portable application in motorhome and caravan

without illustration: Accessories Kit

Includes a support foot and a 230 V mains adapter.

For TV set	Item no.	Price
19" – 24"	70 052	39.90
27"	70 053	39.90

POWERED BY **AVTEX**

- Pre-programmed channel lists for D/ AT/CH/FR and update support by tenHaaft
- Power switch On/ Off
- Certificate of Conformity by KBA (German Federal Motor Transport Authority)
- 3 years manufacturer's warranty
- In-/ Outputs:**
 - 3 x HDMI inputs (1 of them with HDMI ARC)
 - 2 x USB 2.0 type A for power supply and data mediums
- CI+ slot for CA modules
- SPDIF optical output
- Headphone output 3.5 mm stereo jack connector
- AV IN (via optional 3.5 m jack adapter cable)
- IEC-socket for terrestrial reception
- F-socket for satellite reception
- Network (100 Mbit LAN) RJ45 socket
- AVTEX DC input socket, protected against polarity reversal

Technical data:	Oyster Smart TV 19,5"	Oyster Smart TV 21,5"	Oyster Smart TV 24"	Oyster Smart TV 27"
Energy efficiency class	E (Spectrum A ← G)	E (Spectrum A ← G)	E (Spectrum A ← G)	E (Spectrum A ← G)
Energy consumption	12 kWh / 1000h	15 kWh / 1000h	17 kWh / 1000h	21 kWh / 1000h
Screen size	19.5" (50 cm)	21.5" (55 cm)	24" (61 cm)	27" (69 cm)
Resolution	1366 x 768 pixels	1920 x 1080 pixels	1920 x 1080 pixels	1920 x 1080 pixels
Brightness	220 cd/m ²	250 cd/m ²	250 cd/m ²	220 cd/m ²
Contrast ratio	1000:1	3000:1	1000:1	1000:1
Viewing angle	H 178° V 178°	H 176° V 176°	H 176° V 176°	H 176° V 176°
Music power	2 x 2 W	2 x 2 W	2 x 2 W	2 x 2 W
Dimensions (W x H x D)	43 x 25.3 x 4.5 cm	48.8 x 29.4 x 4.9 cm	54 x 32.3 x 4.6 cm	61.9 x 37 x 4.9 cm
Weight	2.5 kg	2.9 kg	3.5 kg	4.2 kg
Item no.	70 201	70 202	70 203	70 204
Price	539.00	599.00	649.00	749.00

Oyster[®] Soundbar

Impressive sound, versatile connectivity options and elegant design. The Oyster[®] soundbar offers a 2-way loudspeaker system and is the perfect complement to the Oyster[®] TV. Moreover, it is compatible with other TV sets. The installation is easy, connected via HDMI ARC, COAXIAL or AUX. Moreover, a direct replay of music via mobile phone or tablet is possible via USB or Bluetooth.

Performance features:

Output power 2 x 10 W, energy consumption 12 V 0.75 A / 24 V 0.42 A, operating voltage 12 V, 24 V, 240 V (only with mains adapter), ports HDMI ARC, COAXIAL, AUX, USB interface for direct music replay, 3 sound effects selectable (EQ) NEWS, Normal, Music, compatible with most TVs, dimensions (W x H x D) 43.6 x 4.6 x 6.8 cm, weight 1.2 kg. Manufacturer's warranty: 3 years.

175.00 **Oyster[®]**
Soundbar**Scope of delivery:**

Soundbar, remote control, mounting bracket for direct installation onto "Oyster[®] TV", AUX cable, COAXIAL cable, HDMI ARC cable, net adapter 110 V – 240 V AC with EURO Schuko plug, power connection cable 12 V/ 24 V.

70 060 175.00



SONY

1



440.00

770.00

Media receiver without drive

2



849.00

1| Moniceiver Sony XAV-AX3250

2-DIN device with 7" touch screen.

82 506 440.00

2| Moniceiver Sony XAV-AX8150

1-DIN device with 9" touch screen, which is adjustable in inclination, depth and height. Additionally equipped with an HDMI input.

82 507 770.00

3| Moniceiver Sony XAV-AX8150TR

Like XAV-AX8150, suitable for Ford Transit built since 2019/07, with mounted 1-DIN radio and radio preparation ex works. With CAN interface and antenna splitter.

82 509 849.00



Pioneer

Moniceiver With Navigation App Pioneer SPH-EVO950 DAB-C

9" (22.8 cm) moniceiver with WiFi, Android Auto, Apple CarPlay and Sygic motorhome navigation via smartphone app. With DAB+, VHF and Bluetooth (hands-free module, 2 mobile phones, audio-streaming). Smartphone connection via USB or wireless. Including interface for steering wheel remote control. Motorhome navigation app Sygic including 3 years card updates for up to 5 family members. Europa motorhome navigation, ProMobil data base with information on 20,000 campsites, iOS/ Android (via Apple CarPlay, Android Auto or Weblink 2.0), can be used online (with traffic information and assistant features) and offline via device display and smartphone. For more information: sygic.com.



949.00

SPH-EVO950DAB-C-T for Ford Transit



949.00

SPH-EVO950DAB-C-D for Fiat Ducato

WLAN 3 years card updates

Technical data:

Construction type 1-DIN, display size 9" (22.7 cm), media ports: 2 camera inputs, 3-channel pre-amplifier, AUX, A/V port back, USB, resolution 1024 x 600 pixels, Bluetooth, DAB tuner, compatibility Android Auto, Apple CarPlay, Weblink 2.0, Spotify, Android, iOS, weight: 1.9 kg.

Equipment features:

Equaliser, hands-free module, USB, charging function, prepared for steering wheel remote control, Multicolor illumination, phone book synchronisation, adjustable front.

Moniceiver with motorhome navigation via smartphone app

Available vehicle-specific in 3 versions

Pioneer SPH-EVO950DAB-C-D7

Suitable for Fiat Ducato built since 2014/04 - 2021/08 as well as Peugeot Boxer and Citroën Jumper built since 2014/04 with radio preparation.

82 521 949.00

Pioneer SPH-EVO950DAB-C-D8

Suitable for Fiat Ducato built since 2021/09 with radio preparation. Not suitable for Peugeot Boxer and Citroën Jumper.

82 522 949.00

Pioneer SPH-EVO950DAB-C-T

Suitable for Ford Transit built since 2019/07 with ex works installed 1-DIN radio or radio preparation.

82 525 949.00



Pioneer

Navigation System Pioneer AVIC-Z1000DAB-C

The media centre AVIC-Z1000DAB has been specifically developed for dashboard installation of motorhomes and combines cable-free smartphone connectivity with offline navigation. It delivers detailed data to more than 20,000 campsites from the Promobil portfolio, integrates into on-board electronics and also controls the optional Headup display SDA-HU100 (only Fiat Ducato 7 and 8). Via the capacitive 9" display of the AVIC-Z1000DAB, iPhones and android smartphones can be controlled without cables thanks to Apple CarPlay and Android Auto. The specific motorhome navigation takes dimensions and vehicle weight into account. A prominently placed operation element with rotary knob and button for camera direct switch provides access to the most important features- no need to use the touch panel.

Technical data:

Model 2-DIN (vehicle-specific), display size 9" (23 cm); media ports: 2 x camera input, 3-channel pre-amplifier, rear A/V output, rear A/V input, 2x USB, resolution 800 x 480 pixels; Bluetooth, DAB+ tuner, compatibility: Apple CarPlay wireless, Android Auto wireless; Wireless Mirroring, WeLink; integrated navigation; software type motorhome / caravan; card material HERE; navigation updates for 3 years; Camper POIs BordAtlas; compatible Headup display SDA-HU100 (only for Fiat Ducato 8); weight 6 kg.

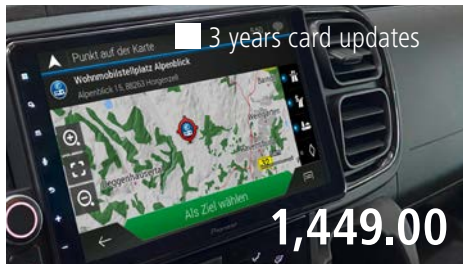

AVIC-Z1000DU8-LFH3 for Fiat Ducato 8

Equipment features:

Theft protection, Dual-Zone function, equalizer, hands-free function, guiding lines for reversing camera, combined regulator, external microphone, voice control, phonebook synchronisation

Available vehicle-specific in 3 versions

Pioneer AVIC-Z1000DU7-LF3

Suitable for the Fiat Ducato built 2014/04 – 2021/08 as well as the Peugeot Boxer and Citroën Jumper built since 2014/04 with radio preparation. **82 541 1,449.00**

Pioneer AVIC-Z1000DU8-LFH3

Suitable for Fiat Ducato 8 built since 2021/09 with radio preparation. Not suitable for Peugeot Boxer and Citroën Jumper. **82 542 1,449.00**

Pioneer AVIC-Z1000DAI-LF3

Suitable for Iveco Daily built since 2018 with radio preparation. **82 543 1,449.00**

699.00



Information

Not applicable for vehicles with Dometic wind-screen darkening FP 200 and FP 300.

Pioneer Head-Up-Display

Retrofit-set for Fiat Ducato 7 or 8, also specifically suitable for connecting it to the navigation system AVIC-Z1000DU. On the display, if installed by the manufacturer, the driving-assistant systems traffic sign recognition and lane-keeping assistant as well as the speed (also without AVIC) can be displayed. If connected to the navigation system Pioneer AVIC-Z1000DU, also the display of navigation directions is possible. Brightness and viewing angle of the retractable display are adjustable.

Technical data:

Power supply 9 – 16 V, max. power consumption 0.18 A on average for 12 V at its brightest setting, operating temperature -10 °C to +85 °C, protective circuits might reduce brightness or deactivate image output entirely, dimensions without speedometer top W 16.7 x H 13.1 x D 13.1 cm, weight without speedometer top 350 g, panel diagonal 1.24" (3.15 cm), resolution 336 x 168 pixels, optic LCD, light source LED, vision distance 2.3 m, dimension of the virtual image 10.5" (26.67 cm), contrast 500:1.

Scope of delivery:

Head-Up display, appliances cover speedometer top, cable kit with interfaces for CAN-Bus and AVIC, Quick Start guide.

For year of construction	Item no.	Price
2014/04 – 2021/08	82 555	699.00
2021/09 – ...	82 548	699.00

i DAB+ caravanning navigation system with Wireless Apple Carplay and Android Auto as well as WiFi and Bluetooth.

caratec

279.00



1 | Dualview Camera Incl. Brake Light Console Safety CS150

Compact camera with 2 angles for down and back view. Both are displayed simultaneously on one display.

Dualview camera Safety CS150BLA

For the Fiat Ducato van built since 2006/07. **82 648 279.00**

Dualview camera Safety CS150BP

For Pössl with camera preparation. **82 657 279.00**

Technical data:	1 CS150BLA / CS150BP	2 CS120BLA / CS120BP / CS115B
Casing colour	black	black
integrated microphone	—	—
Image sensor	1/4" Colour-CMOS	1/4" Colour-CMOS
Viewing angle (D/V/H)	175° --- 130°	158° 95° 123°
Light sensitivity	0.01 Lux	0.01 Lux
LED	—	—
Resolution	308,610 pixels	307,200 pixels
Nominal voltage	12 V	12 V
Temperature range	-30 – +70 °C	-20 – +70 °C
IP protection class	IP69	IP68
Cable length	15 m (only CS150BLA)	15 m (only CS120BLA)
Dimensions (W x H x D)	34.5 x 7.4 x 4.4 cm	34.5 x 7.4 x 4.4 cm

Cameras for every application

2 | Reversing Cameras Safety Incl. Brake Light Console

Wide-angle cameras, which with their angle of 150° are perfectly adjusted to their installation position. They are simply integrated into the console for the third brake light, which is included in delivery, and are installed with it between chassis and brake light. The existing brake light can be used further. A seal on the side of the chassis prevents moisture from intruding.



The version Safety CS120BLA (item no. 82 647) contains a 15 m connection line, suitable for moniceivers and navigation systems with RCA camera input.

from 189.00

Reversing camera Safety CS120BLA

For Fiat Ducato vans built since 2006/07. **82 647 219.00**

Reversing camera Safety CS120BP

For Pössl with camera preparation. **82 672 219.00**

Reversing camera Safety CS115B

For Hymer, Carado, Sunlight and Roadcar with camera preparation. **82 673 189.00**



Navigation System Blaupunkt Hamburg 948 DAB

This 1-DIN multimedia navigation system by Blaupunkt provides a world full of innovation, comfort and a variety of functions. The large 10.1" HD TFT display ensures crystal-clear images and an immersive user experience. The capacitive touch panel makes effortless navigation possible, while the Split Screen mode can display multiple functions simultaneously. The integrated GPS navigation system with 3 years of free updates leads you safely to your destination. The Hamburg 948 captivates with its wireless



859.00 ■ 2 years card updates
■ DVD

✓ The inexpensive alternative

freedom with the Apple CarPlay and Android Auto connectivity. The Phone Link functions enables a seamless smartphone integration.

Technical data:

Construction form 1-DIN; IPS-HD panel; display size 10.1" (25.6 cm); media ports: 4 camera inputs, 3 channel-pre-amplifier output, A/V rear input, 3 x USB; resolution 1280 x 720 pixels; Bluetooth; DAB+ tuner; compatibility: Apple CarPlay wireless; Android Auto wireless; Navigation integrated; software type: motorhome/ caravan; navigation updates 3 years; output power 4 x 50 W; dimensions W 37 x H 28 x D 24 cm, weight 2.7 kg.

Equipment features:

Display adjustable in height, rotation and inclination, permanent memory, external microphone, integrated microphone, prepared for steering wheel remote control. **82 550 999.00**

Navigation System Blaupunkt Camper 690 DAB

Camper navigation and entertainment system for the Fiat Ducato with 6.75" TFT touch displays, TMC traffic data and an extensive range of functions and connections. The Blaupunkt high-end tuner and the DAB+ tuner offer clear radio reception. A reversing camera can be connected to the camera input so that you always have an overview when manoeuvring. Prepared for steering wheel remote control, delivery includes TMC module, IR remote control, external microphone and DAB+ aerial.

Blaupunkt Camper 690 DAB

Suitable for Fiat Ducato built 2006/07 – 2021/08 as well as Peugeot Boxer and Citroën Jumper built since 2006/07. **82 561 859.00**



NEW

999.00



WLAN ■ 3 years card updates

✓ large 10.1" TFT touch display

Technical data:

Mounting type 2-DIN, vehicle-specific, Screen size 6.75" (17.2 cm), Media ports 2x USB, 2 camera inputs, 2 microSD card reader, A/V ou tput rear, A/V input front/rear, preamplifier output, Resolution 800 x 480 pixels, Operating system Windows CE, Bluetooth, DAB-Tuner, Compatibility Android, iOS, Navigation integrated, Software type Motorhome, Map material iGo, Navigation features TMC, destination input via coordinates, own POIs importable, Navigation updates 2 years, Camper POIs promobil, Weight 2.9 kg

Blaupunkt Camper 690 DAB D8

Suitable for the Fiat Ducato 8 built since 2021/09. Not suitable for Peugeot Boxer and Citroën Jumper. **82 553 859.00**

PerfectView CAM 35 NAV

Innovative camera solution specifically developed for the Fiat Ducato van built since 07/2006 (X250 and X290). It integrates the small cylinder camera (CAM 35) with wide-angle lens for a particularly large viewing angle while manoeuvring into a built-on breaklight console. The original breaklight is continuously used. Moreover, the console offers the option to install a second, optional camera (CAM 35FS) with a 60° telephoto lens for distant vision to the back while driving. The vehicle-specific design of the consol provides a perfect fit and an easy installation - without additional drilling into the car chassis. The camera casing is sealed with silicone water-tightly, so that additional sealing is unnecessary. For the perfect optics, it can be lacquered in the vehicle's colour.



CAM 35 NAV

CAM 35FS

from 299.00

149.00

✓ Mounting in the brake light console

without illustration: Switch CAM 35

For simultaneous connection of the two cameras PerfectView CAM 35 NAV and CAM 35FS to one monitor with just one camera input. Upon changing into reverse gear, the switch automatically activates the close-up camera and changes the camera image The remote control camera remains activated while the vehicle is in motion. No separate power supply required. Length: 30 cm. **82 670 55.00**

	Item no.	Price
CAM 35 NAV	82 667	299.00
CAM 35 FS	82 668	149.00
CAM 35 NAV Twin	82 660	449.00



PerfectView CAM 35 NAV Twin

Also available as a twin version, which integrates 2 cameras in a body-mounted brake light console specially designed for the Fiat Ducato panel van from model year 2006/07 (X250 and X290). The small cylinder camera (CAM 35) with wide-angle lens for a particularly wide viewing angle when manoeuvring and the long-range camera (CAM 35FS) with 60° telephoto lens for a view to the rear while driving are installed. The original brake light is still used – without additional holes in the bodywork.

Technical data:

Casing colour black, Image sensor 1/4" Colour-CMOS, Viewing angle (D/V/H) 150° | 90° | 115° (CAM 35 NAV) / 110° | 65° | 85° (CAM 35FS), Light sensitivity < 1.5 Lux, Resolution 345,000 pixels (CAM 35 NAV) / 307,000 pixels (CAM 35FS), Nominal voltage 12 V, Temperature range -30 – +70 °C, IP protection class IP69K, Cable length 15 m, Dimensions (WxHxD) 37.5x8.2x4.4 cm



Navigation Systems ESX

The ESX naviceiver provide perfect infotainment for the Fiat Ducato platform built since 2006/07 and for the Ford Transit built since 2019/07. The devices include the iGo Primo Nextgen Camper navigation software for 46 countries with editable vehicle parameters and allow multiple card updated within 3 years. The high-resolution touchscreen is matt AR coated, providing perfect vision at all times. Moreover, all versions are extensively equipped with ports for front and re-

versing camera, FM/ DAB+ radio, audio/ video player, data manager, Bluetooth hands-free module incl. audio streaming, Media Connect to connect Android and iOS smartphones, WiFi/ Hotspot function. They provide an Octa-Core processor, 4 GB RAM and a quick 64 GB flash hard drive, which ensures a fluent and surprisingly fast operation performance. Thanks to the preinstalled Android operating system and 4G/ LTE dongle (except VNC830 and VN1030, require

an optional SIM card with data volume), you have mobile internet at all times. This way, you have access to Google Play and can use all compatible apps while travelling. As a result, you could watch current news and feature films via the ARD or ZDF (public german TV channels) media centre at your holiday destination.



8"
TOUCHSCREEN
INSTALLATION
SET

INKL. 3 JAHRE
KARTENUPDATES



Navigation System ESX Vision VNC830

- Installation set for Fiat Ducato built since 2021/09 and vehicles identical in construction (Citroën Jumper and Peugeot Boxer)
- 8" (20.3 cm) touchscreen display
- AR display, large rotary knob
- Supports steering wheel remote control
- Bluetooth telephony incl. audio streaming
- Android OS incl. Google Play
- Camera direct button
- USB ports, Media Connect
- iGo Primo Nextgen Camper navigation software
- Incl. 1 year Live-Traffic

VNC830 DBJ *	82 483	949.00
VNC830 F8 *	82 482	949.00

Navigation System ESX Vision VNC940

- Installation set for Fiat Ducato and vehicles identical in construction (Citroën Jumper und Peugeot Boxer)
- 9" (22.8 cm) touchscreen display
- AR display, large rotary knob
- Supports steering wheel remote control
- Bluetooth telephony incl. audio streaming
- Android OS incl. Google Play
- Camera direct button
- USB ports, Media Connect
- iGo Primo Nextgen Camper navigation software
- 1 year Live Traffic inclusive

9"
TOUCHSCREEN
INSTALLATION
SET

VNC940 DBJ 4G *	82 498	1,099.00
VNC940 F8 4G *	82 486	1,099.00

Navigation System ESX Vision VNC940 TRC 4G

+ for Ford Transit

- Installation set for Ford Transit built since 2019/07
- 9" (22.8 cm) touchscreen display
- AR display, large rotary knob
- Supports steering wheel remote control
- Bluetooth telephony incl. audio streaming
- Android OS incl. Google Play, 4G/ LTE function
- Camera direct button
- USB ports, Media Connect
- iGo Primo Nextgen Camper navigation software
- Incl. 1 year Live-Traffic

4G LTE

9"
TOUCHSCREEN
INSTALLATION
SET



4G LTE

10.1"
TOUCHSCREEN
WITH
CONSOLE

Power switch
and camera
direct button

from **1,349.00**

Console for the Fiat Ducato
built since 2021/09.

Navigation System ESX Vision VNC1045

- Large built-in console for Fiat Ducato and vehicles identical in construction
- 10.1" (25.6 cm) touchscreen display
- AR display
- Supports steering wheel remote control
- Bluetooth telephony incl. audio streaming
- Android OS incl. Google Play, 4G/ LTE function
- Camera direct button
- USB ports, Media Connect
- iGo Primo Nextgen Camper navigation software
- 3 years Live-Traffic included

VNC1045 DBJ 4G *	82 491	1,349.00
VNC1045 F8 4G *	82 488	1,449.00

4G LTE

1,249.00

Camera direct
button via
rotary knob



* Versions "DBJ" for Fiat Ducato (2006/07 – 2021/08), Citroën Jumper and Peugeot Boxer (since 2006/07). Versions "F8" for Fiat Ducato (since 2021/09)!



Moniceiver ESX Vision VN1030

Universal 1-DIN i30 Smart moniceiver with 25.6 cm (10.1") touchscreen display with integrated DAB+ digital radio and AM/ FM radio with RDS function. Effortless smartphone connectivity via USB cable for a safe operation via Apple CarPlay, Android Auto. Including Bluetooth hands-free module with audio streaming

- Custom-fit for Fiat Ducato and vehicles identical in construction (Citroën Jumper and Peugeot Boxer)
- Unobtrusive operation panel on the left
- Quick ARM Cortex A9 multicore processor
- Navigation via smartphone
- Supports steering wheel remote control
- Internal and external microphone
- Linux operating system
- Camera direct button
- 2x USB ports with charging function



699.00 **NEW**

* Versions "DBJ" for Fiat Ducato (2006/07 – 2021/08), Citroën Jumper and Peugeot Boxer (since 2006/07).
Versions "F8" for Fiat Ducato (since 2021/09)!

Technical data:

Construction form 1-DIN, display size (10.1" (25.6 cm), media ports: inputs for dual or front and reversing camera, pre-amplifier output for front/subwoofer, AUX, , A/V rear input, USB; resolution 1024 x 600 pixels; Bluetooth; DAB tuner; compatibility: Android Auto, Apple CarPlay, 4 x 50 W audio-amplifier.



VN1030-DBJ * **82 597** **699.00**
VN1030-F8 * **82 598** **699.00**

Smart moniceiver with large 10.1" touchscreen display

1 | Reversing Camera FF-DUC100

Camera particularly designed for the installation into the 3. brake light of the Fiat Ducato van built since 07/2006, providing perfect vision even at night thanks to infrared LED support. As the original brake light console is still used, and only the glass of the brake light is exchanged, it can easily be seen why the camera's installation is very easy and no extra drilling holes into the chassis are necessary. The camera is dust- and water-tight following IP69; connection cable length: 15 m.

82 616 **169.00**



3 | Reversing Camera ESX VNA-RCAM-DBJ220-15

Camera for short and long distance view for installation on the Fiat Ducato built since 2006/07. The small wide-angle camera with its 178° provides a particularly large viewing angle while manoeuvring, while the opposing, integrated wide-angle lens ensures a perfect view of the subsequent traffic. The LED-support ensures perfect night vision. Both cameras are already integrated into the brake console included delivery, which in turn is installed onto the original brake light of the chassis. A seal on the chassis-side prevents the intrusion of moisture. The 15 m connection cable is suitable for moniceivers and navigation devices with 2 video ports, or to connect the cameras to 2 monitors.

82 694 **299.00**



3

Breaklight console with integrated LEDs

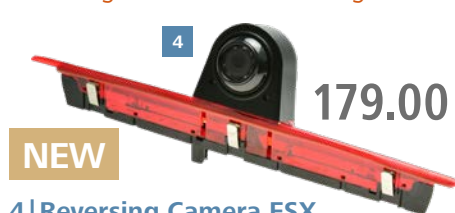

NEW

Reversing Cameras ESX Ford Transit

Compact reversing cameras for the Ford Transit built since 2019/07 to install the third brake light. With its large 178° viewing angle, the cameras provide perfect vision. Night-vision mode thanks to IR LED support. Both cameras are integrated into the brake console included in delivery, which is installed onto the vehicle together with the original brake light. The 15 m long connection cable is suitable for moniceiver and navigation devices with 2 video inputs, or to connect the cameras to 2 monitors.

4 | Reversing Camera ESX VNA-RCAM-TRC160-15

Individual camera for perfect vision while manoeuvring.

82 687 **179.00**

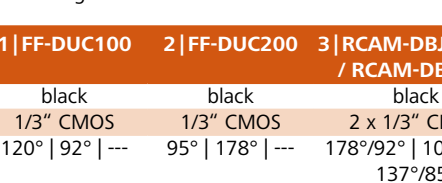

2 | Reversing Camera FF-DUC200

Double camera specifically designed for the Fiat Ducato built since 07/2006, which is attached to the brake light just as the FF-DUC100. In doing so, one lens is directed downward as a parking view, the second for long distance view to the back. Included in delivery are 15 m special camera cable to connect 2 monitors or naviceiver with 2 video ports.

82 692 **229.00**



2

299.00



5

NEW

5 | Twin-Reversing Camera ESX VNA-RCAM-TRC260-15

To monitor the subsequent traffic while driving as well as the area behind the vehicle while manoeuvring. It can be connected to navigation systems and moniceivers with multiple camera inputs.

82 688 **249.00**

Technische Daten:	1 FF-DUC100	2 FF-DUC200	3 RCAM-DBJ220-15 / RCAM-DBJ225	4 RCAM-TRC160-15	5 RCAM-TRC260-15
Casing colour	black	black	black	black	black
Image sensor	1/3" CMOS	1/3" CMOS	2 x 1/3" CMOS	1/3" CMOS	2 x 1/3" CMOS
Viewing angle (D/V/H)	120° 92° ---	95° 178° ---	178°/92° 104°/51° 137°/85°	133° 76° 106°	178°/92° 104°/51° 137°/85°
Light sensitivity	0 Lux	1 Lux	0.1 Lux	0.1 Lux / 0 Lux with LEDs	0.1 Lux
LED	✓	---	✓	✓	---
Resolution	291,000 pixels	472,384 pixels	968 x 488 pixels	968 x 488 pixels	968 x 488 pixels
Nominal voltage	12 V	12 V	12 V	12 V	12 V
Temperature range	-30 – +70 °C	-30 – +70 °C	-30 – +70 °C	-30 – +70 °C	-30 – +70 °C
IP protection class	IP69K	IP69K	IP69K	IP69K	IP69K
Cable length	15 m	15 m	15 m *	15 m	15 m
Weight	680 g	680 g	350 g	720 g	720 g



Navigation System ESX Multi-Angle

- Set with installation frame and storage compartment, custom-fit for the original radio slot of the Fiat Ducato and vehicles identical in construction (Citroën Jumper und Peugeot Boxer)
- 10.1" (25.6 cm) touchscreen display
- Horizontally and vertically rotatable display
- Frosted AR display
- Large rotary knob and control elements
- Freely programmable function key
- Supports steering wheel remote control
- Bluetooth telephony incl. audio streaming
- Android OS incl. Google Play
- 4G/ LTE function
- Camera direct button
- 2 USB ports with charging function
- Media Connect
- iGO Primo Nextgen Camper navigation software
- 3 years Live-Traffic included

10.1"
TOUCHSCREEN
INSTALLATION
SET



1,249.00

VNC1061-DBJ-4G *	82 492	1,249.00
VNC1061-F8-4G *	82 493	1,249.00

+ With horizontally and vertically rotatable display



INKL. 3 JAHRE KARTENUPDATES



Freely rotatable display



Information * Versions "DBJ" for Fiat Ducato (2006/07 – 2021/08), Citroën Jumper and Peugeot Boxer (built since 2006/07). Versions "F8" for the Fiat Ducato (built since 2021/09)!

Charging Cradle CARICA

With the innovative charging station CARICA, phones can comfortably be charged wirelessly. The charging cradle is integrated tailor-made into the dashboard of the Fiat Ducato and charges every smartphone which is suitable for inductive charging following the Qi standard. The smartphone just has to be put on top of the charging station. The charging process can be controlled by an on and off button to

increase the battery life. The closable cover prevents the smartphone from falling out or sliding while driving. CARICA is connected via Plug & Play to the on-board power supply, appropriate vehicle-specific cables are already included in delivery and available in two versions which support more than inductive charging. Both also have extension cables with 2 USB, USB/ AUX or USB/HDMI ports.



Connectors	Year of construction	Item no.	Price
—	2014/05 – ...	81 071	179.00
USB/AUX	2014/05 – ...	81 073	179.00
USB/HDMI	2014/05 – ...	81 074	179.00



179.00

INBAY Qi Charging Station

This charging cradle perfectly integrated into the original dashboard and prevents an overheating of the smartphone or charging device. The smartphone can simply be charged while being used, for example for navigation or music. Simple installation with Plug & Play cable, no other cable kit is required. INBAY is compatible with all smartphones working with the Qi standard. Non-Qi-compatible devices with micro USB port can be easily retrofitted to meet the Qi standard with accessories. This way, nearly every smartphone can be charged wirelessly.



199.00



Extension cable with USB/AUX or USB/ HDMI ports.

NEW

Vehicle model	Item no.	Price
Fiat Ducato Typ 250/290		
2006/07 – ...	81 059	199.00
Ford Transit		
2019/07 – ...	81 061	199.00



Garmin VIEO RV

Dock Garmin VIEO RV52

The fully integrated, yet mobile infotainment system in its 2 versions combines camper-specific Garmin navigation with the extensive Fusion premium entertainment. The system consists of the vehicle-specific RV 52 Stereo Dock installation element, onto which the selected control panel (to be ordered separately) with 8" or 10" screen is placed. The control panel can be detached from the radio and used as a remote control in the interior and exterior of the motorhome. Besides the vehicle-specific routing, an integrated hands-free function, voice control as well as driver assistance with notifications of danger points provide additional security while driving. Via smartphone and the Garmin Drive™ app, users receive smart notifications, traffic information, weather data and more in real time directly on the display.

749.00 ■ Lifetime Updates



Moreover, comprehensive data bases with camping POIs and information by ACSITM and NKC Campercontact™, Trailer's PARK parking lots for camper and caravans as well as recommendations by TripAdvisor and Foursquare with reviews. Besides the 4 ports for the installation of compatible cameras (for rear and front view as well as indicator-activated side cameras), the pre-



mium sound system offers a variety of media connectivity options such as Apple AirPlay and UPnP. With the multi-zone technology, the sound can be controlled directly via the dock in 4 independent audio zones, the detachable control panel or the FUSION-Link™ app for smartphones.

Features device:

Hands-free module, multi-zone function, voice control, DAB+ tuner, software-type motorhome/caravan

Features navigation:

Camper POIs, vehicle parameters, warnings; Camper POIs: ACSITM, NKC, Trailer's Park™.

Technical data:

Dimensions W 17.8 x H 9.8 x D 13.5 cm, weight 1.1 kg. 82 750 749.00



Control Panel Garmin VIEO RV

Portable displays with display sizes of 8" and 10" to operate the Garmin VIEO RV52 entertainment system. They are inserted into the base unit horizontally and can be used as remote controls both horizontally and vertically.

749.00

VIEO RV852



129.90



VIEO RV1052



849.00

Wall Charging Cradle

Charging station for the control units VIEO RV852 and VIEO RV1052 for installation in the body. 82 759 129.90

	Item no.	Price
VIEO RV852 8"	82 752	749.00
VIEO RV1052 10"	82 753	849.00

without illustration:

Installation Kit Garmin VIEO for Fiat Ducato

Includes an external hands-free microphone, cover, mount, cable harness and an adapter for the steering wheel remote control.

For year of construction	Item no.	Price
2006/07 – 2021/08	82 754	149.90
2021/09 – ...	82 761	149.90

Installation Kit Garmin VIEO for MB Sprinter

Includes external hands-free microphone, cover, mount and cable harness.

For year of construction	Item no.	Price
2006/04 – 2018/02	82 762	199.00
2018/03 – ...	82 755	149.90

Installation Set Garmin VIEO for Iveco Daily Built Since 2014/07

Including external hands-free microphone, cover, bracket, cable harness as well as the adaption for the steering wheel remote control for the Iveco Daily 6 built until 2018. For the Iveco Daily 7, an additional adapter box is required. 82 756 149.90

Sound System ESX DBJ-Kit 1

Two-way, 16 cm (6") loudspeaker systems, particularly developed for the Fiat Ducato built since 2006/06 and vehicles identical in construction. The amplifier set provides a perfect solution for easy installation. The very small 2-channel amplifier hardly takes up any space and can be connected effortlessly with the included ISO cable kit via

Plug&Play. Moreover, the digital amplifier is equipped with extra RCA outputs so that an additional active subwoofer can be actuated. 72 752 429.00

Sound System ESX DBJ-Kit 2

Like ESX DBJ-Kit 1, but with an additional active subwoofer QXFF201A. It is fastened with a special steel frame directly beneath the centre console. Installed this way, the QXF201A practically

"floats" in the air and disrupting vibrations can not transfer onto the console or the dashboard. 72 758 779.00



429.00 NEW



779.00

NEW



169.00



Caratec Audio Sound System

Specially configured active Plug & Play sound systems with amplifier and subwoofer for Fiat Ducato and Mercedes Sprinter built since 2018/03. The amplifier with integrated DSP sound processor optimises the sound of the speakers in the vehicle and drives the powerful subwoofer. The sound processor (DSP) optimises the installation-related weaknesses in the high-frequency reproduction and the subwoofer ensures an extended low-frequency reproduction. This creates a completely new and convincing sound experience. The Plug & Play wiring set enables quick and easy installation, separate connections to the vehicle are not required.

Sound systems for Mercedes Sprinter

Sound system specifically designed for Mercedes Sprinter built since 2018/03 with 6-channel amplifier which significantly improve the sound of the loudspeakers installed in the vehicle. Any loudspeakers existing in the living area, are triggered by the amplifier via a high pass with optimised frequency response. This way, also these loud-

	Suitable for	Connector	Amplifier	Item no.	Price
CAS211S	radio preparation	ISO plug	6 channels	72 730	549.00
CAS212S	MBUX w/o DSP Box	MBUX-plug	6 channels	72 732	599.00
CAS213S	MBUX with DSP Box	ISO plug	6 channels	72 731	549.00

Loudspeaker Set Caratec Audio CAK1650.DU

Consists of 2 loudspeakers (16.5 cm) with coated paper cone and long-term stable rubber surround and 2 tweeters (1.9 cm) with silk membrane. The vehicle-specific loudspeaker system provides increased dynamic, clear and pleasant voice reproduction as well as powerful basses. Installation and sound perfectly fit the Fiat Ducato built since 07/2006 and vehicles identical in

construction: the tweeters fit exactly into the slots of the Fiat A-pillar trim and the Remis black-out system, the woofers are already completely pre-assembled and can replace the original woofers in no time.

Scope of delivery:

2 woofers, 2 tweeters, mounting material
72 749 169.00

Sound systems for Fiat Ducato

The basic versions for the driver's cab (CAS200D / CAS201D / CAS207D / CAS215D) include a 4-channel amplifier, the extended versions for the driver's cab and living area (CAS204D / CAS208D) include a 6-channel amplifier, as well as 2 compact loudspeakers with 3 supplied housing vari-

ants for flush, surface and corner installation. The CAS207D and CAS208D versions are specifically designed for use with front-mounted Caratec Audio CAK1650.DU loudspeakers (art. no. 72 749). With the basic versions, any existing speakers in the body are still controlled by the radio.

	Year of construction	Suitable for	Connector	Item no.	Price
CAS200D	2006/07 – ...	radio preparation	ISO plug	72 736	449.00
CAS201D	2014/05 – 2021/08	Fiat radio	Fiat plug	72 737	479.00
CAS204D	2006/07 – ...	radio preparation	ISO plug	72 739	599.00
CAS207D	2006/07 – ...	CAK1650.DU	ISO plug	72 740	449.00
CAS208D	2006/07 – ...	CAK1650.DU	ISO plug	72 741	599.00
CAS215D	2021/09 – ...	Fiat radio	Fiat plug	72 735	479.00

speakers sound more dynamic than before. The version CAS211S is suitable for vehicles with radio preparation. For vehicles with MBUX 7" with navigation and 10" without DSP-box preliminary set-up, the version CAS212S has been designed. For vehicles with MBUX-systems with DSP-box preliminary set-up, the version CAS213S is available.



from 449.00

The Global Harmonized System (GHS) for the EU Classification and Labelling according to Regulation (EG) No. 1272/2008 (CLP-VO)

Hazard and Precautionary Statements

Source: www.baua.de

Dangers, additional hazards and marking elements, coding and wording.

For an explanation of the pictograms and the hazard and safety information, see main catalogue page 858 to 859 and www.frankanafreiko.de!

GHS Pictograms

GHS02		flammable
GHS04		compressed gas
GHS05		corrosive
GHS07		health hazard
GHS09		environmental hazard

H200 Codes: Physical hazards

- H220** Extremely flammable gas.
H225 Highly flammable liquid and vapour.
H280 Contains gas under pressure; may explode if heated.
H281 Contains refrigerated gas; may cause cryogenic burns or injury.

H300 Codes: Health hazard

- H302** Harmful if swallowed.
H314 Causes severe skin burns and eye damage.

- H315** Causes skin irritation.
H318 Causes serious eye damage.
H319 Causes serious eye irritation.
H336 May cause drowsiness or dizziness.

H400 Codes: Environmental hazards

- H410** Very toxic to aquatic life with long-lasting effects.
H412 Harmful to aquatic life with long-lasting effects.

An overview of all precautionary and hazard statements as well as labelling elements can be found on the website of the Federal Institute for Occupational Safety and Health (Bundesanstalt für Arbeitsschutz und Arbeitsmedizin): www.baua.de/EN/Home/Home_node.html

Important!

Please observe the application instructions and safety data sheets for products with hazard labels.

Keep detergents and chemicals out of reach of children!

Physical properties and additional labelling elements

- EUH066** Repeated exposure may cause skin dryness or cracking.
EUH208 May produce an allergic reaction
EUH210 Safety data sheet available on request.
EUH211 Warning! Hazardous respirable droplets may be formed when sprayed. Do not breathe spray or mist.

Space for notes:



adVANture

2024

Frankana®
Caravan und Freizeit GmbH
Südstraße 4
97258 Gollhofen
Germany

Phone +49 9339 97 13 600
Telefax +49 9339 97 13 900
info@frankana.de

Freiko®
Handelsgesellschaft mbH
Industriestraße 2
97258 Gollhofen
Germany

Phone +49 9339 97 13 200
Telefax +49 9339 97 13 500
info@freiko.de



www.frankanafreiko.de/en

Our social media channels



All prices in Euro, incl. German VAT.